

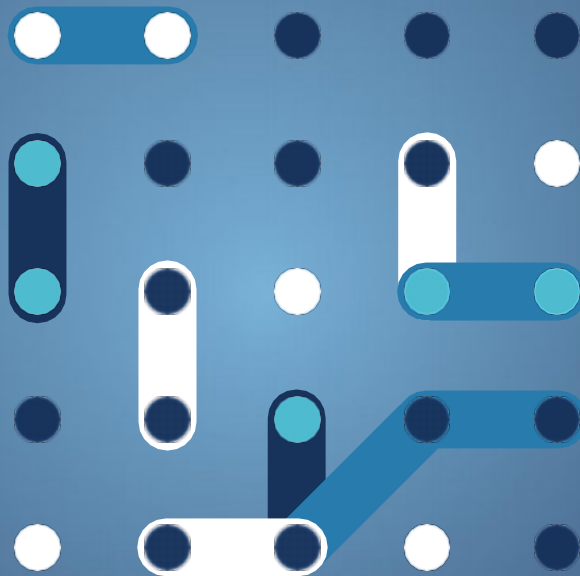

bridge

2023 BROCHURE

The BRIDGE initiative and project fact sheets.



July 2023



AUTHORS

Agnieszka Gierej (ZABALA Innovation)

Niclette Kampata (ZABALA Innovation)

Oihan Berasategi (ZABALA Innovation)

Marcos Jareño (ZABALA Innovation)

Contact: BRIDGE Secretariat E-mails: secretariat@h2020-bridge.eu & management@h2020-bridge.eu

EUROPEAN COMMISSION

Directorate-General for Energy Unit: B5 – Innovation, Research, Digitalisation, Competitiveness

Contact: George Paunescu -E-mail: Mugurel-George.PAUNESCU@ec.europa.eu

European Commission

B-1049 Brussels

CINEA

European Climate, Infrastructure and Environment Executive Agency, Unit C2 – Horizon Europe Energy

Contact: Andrea Feltrin E-mail: Andrea.Feltrin@ec.europa.eu,

Contact: Mariana Stantcheva E-mail: Mariana.STANTCHEVA@ec.europa.eu

European Commission

B-1049 Brussels

ACKNOWLEDGEMENTS

The authors would like to acknowledge the valuable groundwork performed by DOWEL Innovation in the former versions of the document.



BRIDGE

Cooperation between Horizon 2020 and Horizon Europe Projects in the fields of Smart Grid, Energy Storage, Islands, and Digitalisation

2023 BROCHURE

July 2023



LEGAL NOTICE

This document has been prepared for the European Commission. However, it reflects the views only of the authors, and the European Commission is not liable for any consequence stemming from the reuse of this publication. More information on the European Union is available on the Internet (<http://www.europa.eu>).

PDF	ISBN 978-92-68-05726-1	doi: 10.2833/38225	MJ-04-23-748-EN-N
BOOK	ISBN 978-92-68-05727-8	doi: 10.2833/914152	MJ-04-23-748-EN-C

Luxembourg: Publications Office of the European Union, 2023

© European Union, 2023



The reuse policy of European Commission documents is implemented by the Commission Decision 2011/833/EU of 12 December 2011 on the reuse of Commission documents (OJ L 330, 14.12.2011, p. 39). Except otherwise noted, the reuse of this document is authorised under a Creative Commons Attribution 4.0 International (CC - BY 4.0) licence (<https://creativecommons.org/licenses/by/4.0/>). This means that reuse is allowed provided appropriate credit is given and any changes are indicated.

For any use or reproduction of elements that are not owned by the European Union, permission may need to be sought directly from the respective rightholders.



TABLE OF CONTENTS

1 Foreword	6
2 Introduction to the BRIDGE initiative	8
2.1 Purpose of the initiative	8
2.2 BRIDGE Working Groups	9
3 Overview of the BRIDGE projects	10
3.1 Stakeholders involved in BRIDGE projects	12
3.2 Geographical distribution of BRIDGE projects	14
3.2.1 Geographical distribution of stakeholders	14
3.2.2 Number of stakeholders involved per country	15
3.2.3 Geographical distribution of physical demonstrators and pilot	16
3.2.4 Number of demos or pilot sites per country	17
3.3 Technologies and services tackled by BRIDGE projects	18
4 Horizon Europe, Horizon 2020 calls and Project fact sheets	21
4.1 Project fact sheets	21
4.2 Completed BRIDGE projects	21
4.3 Ongoing BRIDGE projects	21
5 Demonstration sites	217
5.1 Demonstration site's location and contacts	217



1 Foreword

The twin green and digital transition of the energy sector is unfolding at full speed. The European Green Deal, the strategy put forward by the European Commission in 2020, sets the scene for this transition. It is the masterplan for successfully transforming our society towards full decarbonisation by 2050, while increasing welfare, having modern, resource-efficient and competitive industries, and ensuring sustainable economic growth, which is decoupled from the use of natural resources.

In 2021, the Commission put forward comprehensive proposals to implement the European Green Deal and guide our energy transition. This is the “Fit for 55” package, which aims to make the EU's climate, energy, land use, transport and taxation policies fit for reducing the net greenhouse gas emissions by at least 55% by 2030, compared to 1990 levels. “Fit for 55” sets the pace of our energy transition and establishes ambitious targets for increasing the share of renewables in the energy consumption and improving energy efficiency across the board.

The pace of the energy transition was further accelerated by the REPowerEU plan and its successive packages of measures adopted since March 2022, which set even more ambitious targets for the energy transition. The plan responded to the unprecedented challenges faced by Europe in terms of its energy security and energy prices. The aim is to make Europe independent from Russian fossil fuels well before 2030, diversify energy supplies, save more energy, and speed up the production of clean energy.

Building on the priorities of the Green Deal and the Path to the Digital Decade programme, the Commission adopted the EU Plan on Digitalising the Energy System in October 2022. It lays down key actions for ensuring that the green and digital dimensions are reinforcing each other when transforming our energy system and the consumers and prosumers (be it individuals or companies) are reaping the benefits. The plan also aims to further investments in smart grids, broaden access to energy data, and support the creation and deployment of digital twins.

The Green Deal Industrial Plan adopted by the Commission in February 2023 promotes a predictable and simplified regulatory environment,

faster access to funding, a focus on relevant skills, as well as an ambitious trade policy to ensure strong and resilient supply chains needed for the twin green and digital transitions. The manufacturing industries that are needed for the continuous development of smart energy systems will be strongly supported, notably through the Net-Zero Industry Act proposed by the Commission in March 2023.

As you can see, the European strategic and regulatory framework is well suited to support a fast and effective energy transition. The EU's increased ambition will spur sustainable economic growth, create jobs, deliver health and environmental benefits for EU citizens, and contribute to the long-term global competitiveness of the EU economy by promoting innovation in green and digital technologies.

This will not be possible without a modern, smart and digitalised energy system. Smart grids are the backbone of smart energy systems. They allow the integration of high shares of distributed renewables, they are more resilient and cost-effective, and they can make use of flexibility services for lowering consumer bills and furthering electrification.

Ensuring the integrity and resilience of the data infrastructure, networks, and communications as a basis for the European technological and data sovereignty and compliance to policies on data protection and data governance are also needed to reach the energy policy targets.

Research and innovation are instrumental in advancing the energy transition, deploying novel technologies and services, and adapting the operation techniques to the technological developments.

The BRIDGE initiative of the European Commission represents a vibrant community of projects funded by Horizon 2020 and Horizon Europe programmes. Established in 2016, BRIDGE brings together projects that are active in the areas of smart grids, energy storage, islands, and digitalisation. BRIDGE fosters continuous knowledge sharing amongst projects and baselining of their activities and results and facilitates the uptake of innovative technologies in the energy sector. It also mobilises the projects to synthesise and deliver joint conclusions and



recommendations on exploiting the key project results and experiences for advancing the delivery of the Green Deal and REPowerEU objectives.

Over the past year, we have witnessed an increase in membership of more than 50% in both the number of projects and their financial values. The community has now reached 155 projects and brings together around 1100 project partners coming from 42 countries. The total EU funding amounts to almost EU 1.4 billion.

We welcome this new brochure of BRIDGE projects, which provides an excellent overview of the participating projects, the implementing partners, demonstrators, innovative technologies and key exploitable results, as well as the geographical coverage. We look forward to continuing working with the member projects, maintaining BRIDGE as a vibrant and inclusive community of knowledge and best practice, and further developing it by adding new partners.

Enjoy your reading and follow the BRIDGE web site for up-to-date information.



Dr. Vincent Berrutto

Head of Unit for "Digitalisation, Competitiveness, Research & Innovation" Directorate-General for Energy, European Commission



Dr. Max Lemke

Head of Unit for "Internet of things", Directorate-General Communications Networks, Content and Technology, European Commission



Robert Goodchild

Head of Unit for "Horizon Europe Energy", European Climate, Infrastructure and Environment Executive Agency, European Commission

2 Introduction to the BRIDGE initiative

2.1 Purpose of the initiative

BRIDGE is a cooperation group involving 155 projects in total (among which 97 are ongoing and 58 ended as of 1st of July 2023) involving 1510 organisations from 39 countries for a total accumulated EC funding to all projects of 1303 M€ in the areas of Smart Grid, Energy Storage, Islands, and Digitalisation funded under the Horizon 2020 and Horizon Europe program over the last 8 years (2015-2023). This collaborative initiative reveals the average growth of 45% per period of 2 years. The number of projects has experienced a remarkable growth of 546% from the beginning of the period (2016-2017) until 2022-2023. In this brochure we report on 147 projects (ongoing and ended) that provided the necessary information to the BRIDGE secretariat for the analysis.

BRIDGE aims at fostering the exchange of information, experience, knowledge, and best practices among its members. Its goal is to provide field experience, feedback and lessons learned from the participating projects to help overcome the barriers to effective innovation. It aims at gathering coordinated, balanced and coherent recommendations to strengthen the messages and maximize their impacts towards policy makers in view of removing barriers to innovation deployment.

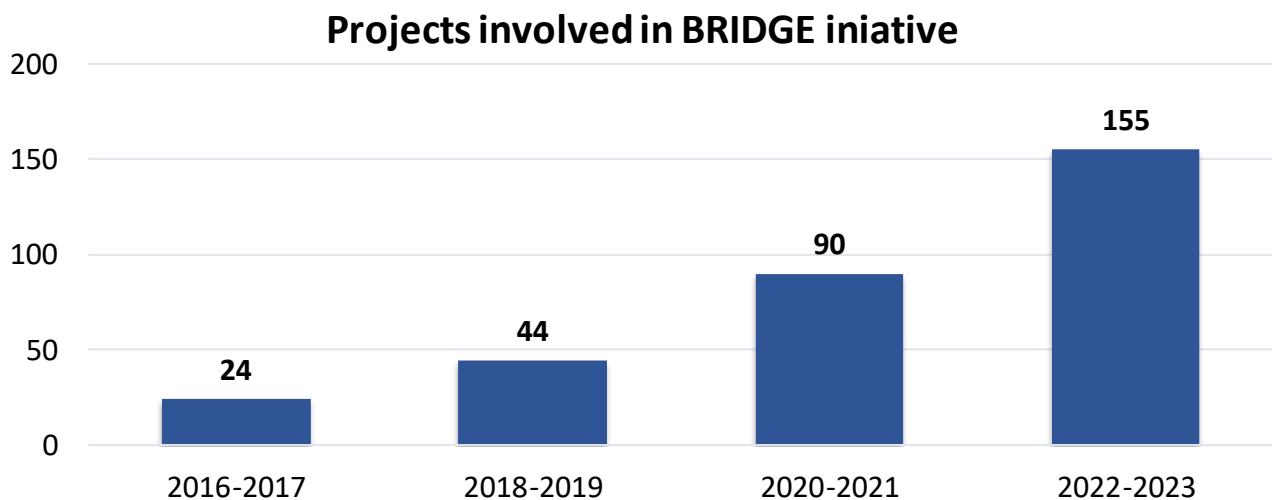

Lunch date 2016	Time frame of the calls 2014- 2023	No. of participating organizations 1510
No. of countries involved 39	No. of projects in total 155 ongoing 97	Accumulated EU funding 1303 M €



2.2 BRIDGE Working Groups

This cooperation group involves four different types of activities (**Working Groups**) addressing cross-cutting issues enlisted as follows:

Data Management

- Embracing the technical and non-technical aspects of the communication infrastructure for data exchange.
 - Entailing data integrity, customer privacy and protection.
 - Data handling, exchange, and data analytics for data processing.

Regulation

- Integration and harmonisation at the level of products and services.
 - Cross-border and regional cooperation.
- Integration of market -based and non-market-based flexibility mechanisms.
 - Coordinated flexibility markets for system services.

Consumer and Citizen Engagement

- Analysis of cultural values, geographical and social dimensions for consumers' understanding.
- Drivers for engagement and effectiveness of engagement activities.
 - Identification of trigger source of behavioural changes.

Business Models

- Business model description and valuation.
- Identifying and evaluating existing and new innovative business models.
- The development of a simulation tool allowing for the comparison of the profitability of different business models applicable to smart grids and energy storage solutions



3 Overview of the BRIDGE projects

	Distribution Grids	Distributed Storage	Transmission Grids	Large-Scale Storage	RES and H&C	Data Exchange
2014 - 2015	2014: 10 projects, 61 M€ 	2014: 7 projects, 73 M€ 	2015: 4 projects, 82 M€ 	2015: 2 projects, 25 M€ 		
2016-2017	2016: 7 projects, 87 M€ 		2017: 4 projects, 76 M€ 		2016: 2 projects, 8 M 	2017: 2 projects, 8 M
2018-2019	2019: 8 projects, 87 M€ 		2019: 2 projects, 20 M€ 			

	TSO-DSO cooperation	Cybersecurity	ICT	Islands
2018-2019	2019: 8 projects, 87 M€ 	2019: 3 projects, 23 M€ 	2018: 1 project, 30 M€ 2019: 4 projects, 38 M€ 	2018: 9 project, 65 M€ 2019: 1 project, 10 M€

	TSO-DSO Cooperation	Energy Islands	Advanced tools	DC	Demand Response	Islands
2020 - 2021	2020: 1 project, 22 M€ 	2020: 3 project, 17 M€ 	2020: 2 project, 8 M€ 	2020: 2 project, 14 M€ 	2020: 7 project, 56 M€ 	2020: 8 projects, 47.5 M€



	Grids technologies	Demand response	Distributed Storage	Large-Scale Storage	Recycling and LCA
2021 - 2022	<p>2021: 5 projects, 41.1 M€</p>	<p>2021: 5 projects, 31.7 M€</p>	<p>2021: 3 projects, 21.4 M€</p>	<p>2022: 5 projects, 37.2 M€</p>	<p>2022: 4 projects, 34.2 M€</p>
	<p>2022: 3 projects, 68.35 M€</p>	<p>2022: 5 projects, 34.6 M€</p>	<p>2022: 7 projects, 33.8 M€</p>		

	Digital and flexible energy systems	Generation
2021 - 2022	<p>2021: 6 projects, 49.2 M€</p>	<p>2021: 11 projects, 102.35 M€</p>
		<p>2022: 1 project, 1.3 M€</p>



3.1 Stakeholders involved in BRIDGE projects

Different types of stakeholders are participating in the BRIDGE initiative.



Consumers include residential, professional, public institutions, and industrial consumers, as well as cities acting as consumers in projects.



Regulated Operators are TSOs, and DSOs as defined by the Electricity Directive



Regulators are the National Regulatory Authorities as defined by the Electricity Directive.



Local Energy Communities are defined as associations, cooperatives, partnerships, non-profit organisations, or other legal entities which are effectively controlled by local shareholders or members, generally value rather than profit-driven, involved in distributed generation and in performing activities of a distribution system operator, supplier or aggregator at local level, including across borders



Power technology providers are hardware manufacturers for power transmission, distribution, and generation technologies. **Storage providers** are considered in a separate category (all storage technologies are considered, including batteries from EVs and hot water tanks). **ICT providers** are software and telecommunication vendors



Research & Innovation stakeholders include research centres, universities, academic institutions, think-tanks, research and innovation consultants



Energy Suppliers include power generators, retailers, energy service companies (ESCOs) acting in the competitive energy market. **Aggregators** are market participants that combine multiple customer loads or generated electricity for sale, for purchase or auction in any organised energy market. **Market operators** include power exchanges, brokers and traders on the energy markets.



Others is a category that covers stakeholders that do not fall in any of the above-defined categories such as international organisations, communication agencies, water supply operators, IT consultancy, technology manufacturers, engineering services, etc.



Some stakeholders fall into several categories: electricity operators on islands for instance, act both as energy suppliers and DSOs; some power technology providers sell ICT tools and storage devices.

The following diagram categorises stakeholders present in ongoing and ended projects according to their dominant role within the BRIDGE initiative:

- The largest group of stakeholders in BRIDGE projects is **Research and Innovation** actors, accounting for **34.5%** of the total stakeholders.
- Technology providers make up 21.5% of the total BRIDGE projects stakeholders, with 13.5% ICT providers, 7% being power technology providers, and 1% storage providers.
- A significant portion of stakeholders (15.4%) falls under the "Other" category.
- Regulated operators, including DSOs (Distribution System Operators) and TSOs (Transmission System Operators), account for 14.5% of the total BRIDGE projects stakeholders.
- Electricity market players represent 8.1% of the total BRIDGE projects stakeholders. This group comprises energy suppliers (5%), market operators (1.6%), and aggregators (1.5%).

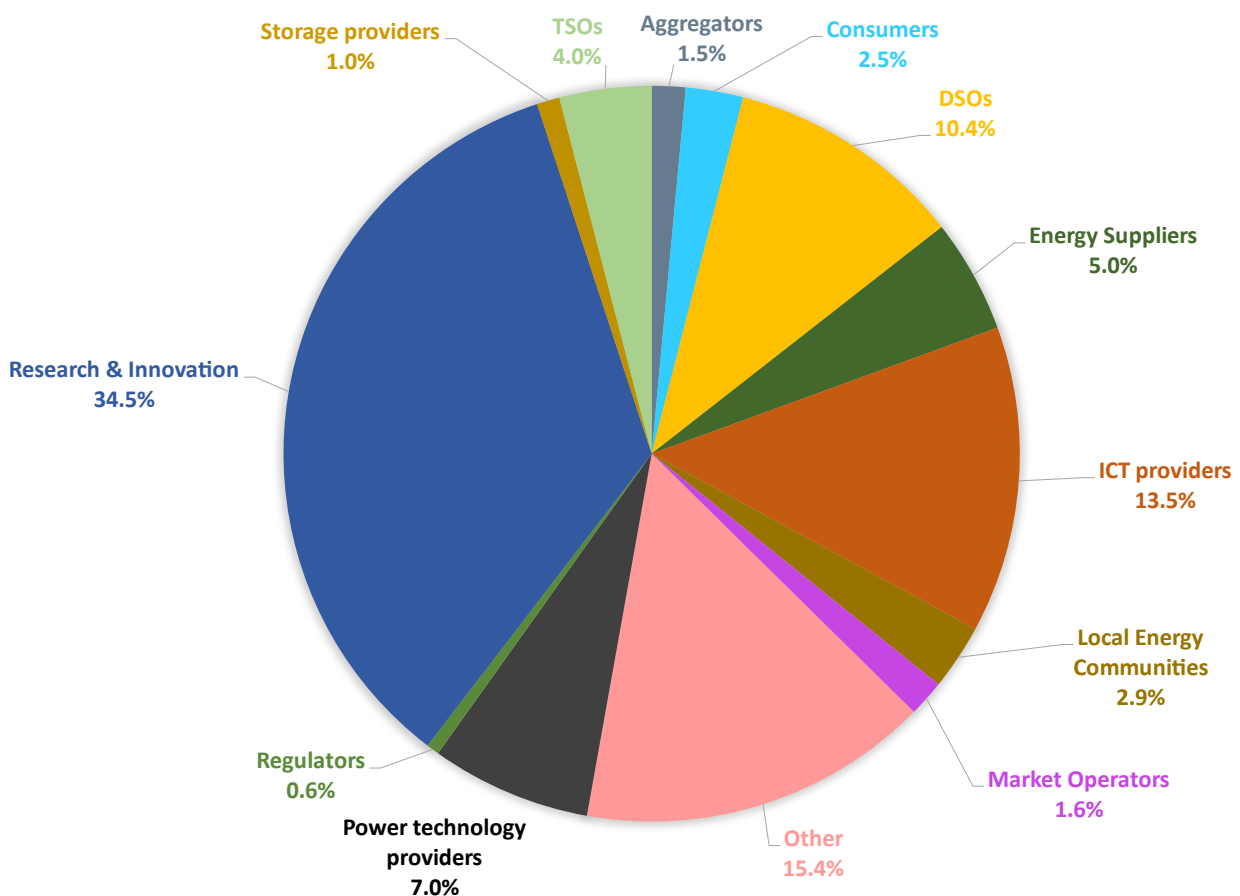



3.2 Geographical distribution of BRIDGE projects

3.2.1 Geographical distribution of stakeholders

BRIDGE projects involve stakeholders from **39 countries** as presented by the figure below.

- The number of projects per country is calculated based on the total stakeholders involved in ongoing and ended projects.
- The number of stakeholders involved per country corresponds to the total number of partners from this country in all the BRIDGE projects.

When the number of stakeholders involved per country is higher than the number of projects, it means that more than one partner from the same country is participating in each project.

In some cases, there are more projects than stakeholders involved for a given country, meaning that the same stakeholders participate in several projects (for example Austria, and Serbia).

Some stakeholders from outside the EU are participating in BRIDGE projects: United Kingdom (88), Norway (37), Switzerland (32), Turkey (16), India (13), Serbia (11), Israel (2), Ukraine (2), Montenegro (2), Iceland (1), Bosnia and Herzegovina (1), and Albania (1).

Country representation in Bridge projects

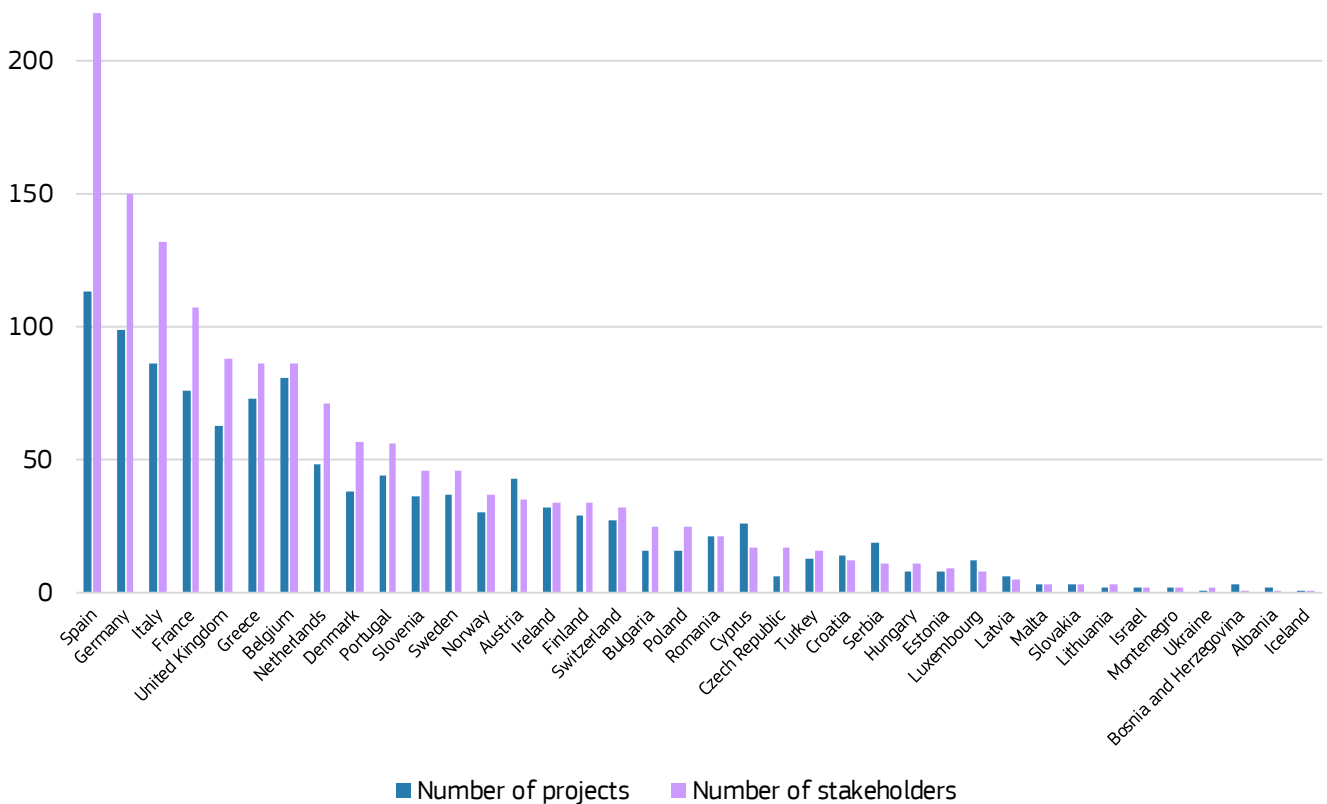



3.2.2 Number of stakeholders involved per country

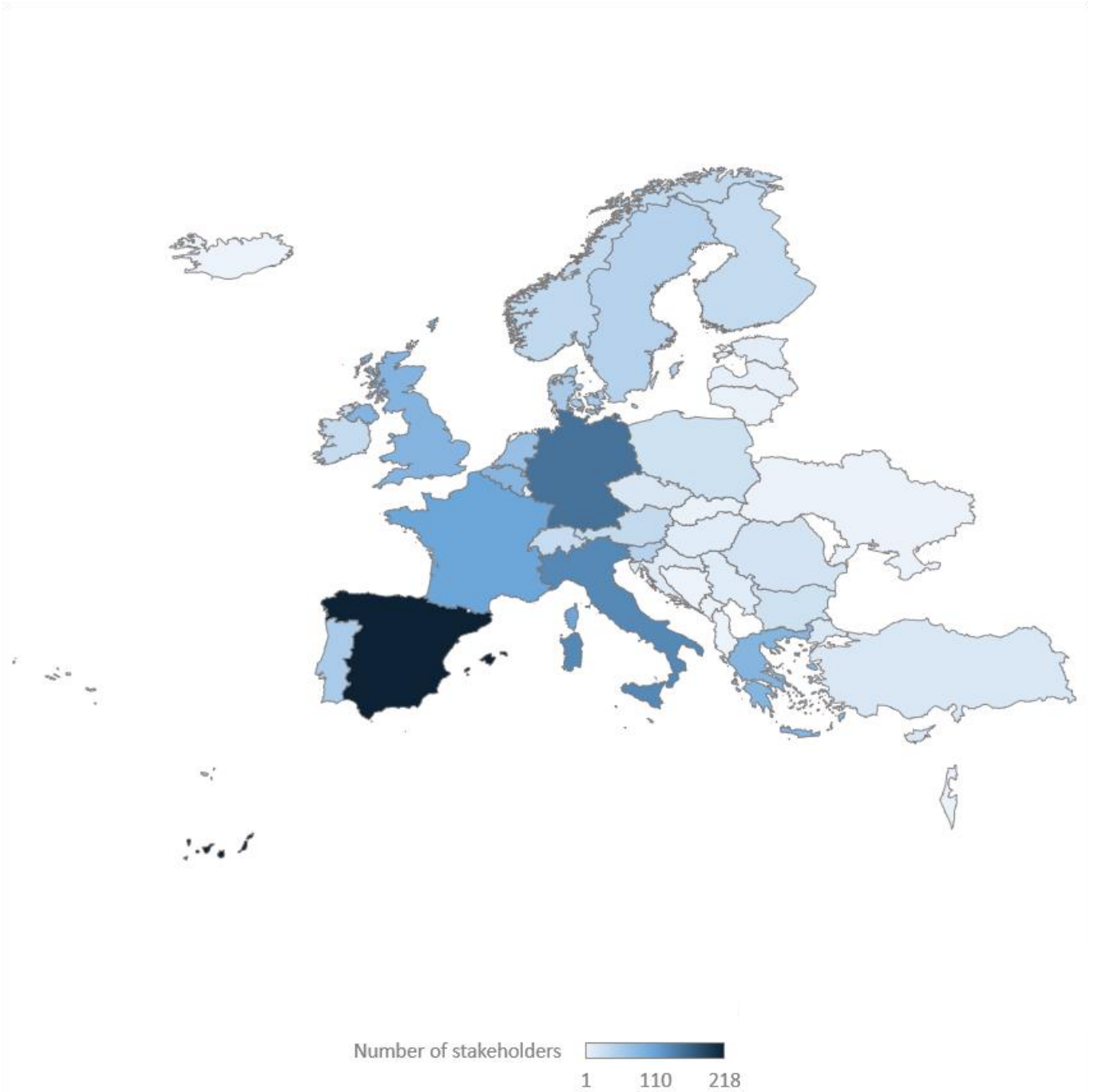



3.2.3 Geographical distribution of physical demonstrators and pilot

Most of the BRIDGE projects involve demonstrations or pilot tests of technologies and solutions.

BRIDGE demos or pilots are hosted by 39 countries as indicated on the figure and the map below. Spain hosts the highest number of demo sites (60), followed by Italy, Greece, Germany, France, Portugal, Slovenia, and Sweden.

Some demos and pilots' sites are hosted outside the EU, namely: United Kingdom (18), Switzerland (14), Norway (11), Turkey (5), Serbia (5), Bosnia and Herzegovina (4), India (6), Iceland (3), Macedonia (3), Israel (1), USA (1), and China (1).

Number of Bridge project demos per country

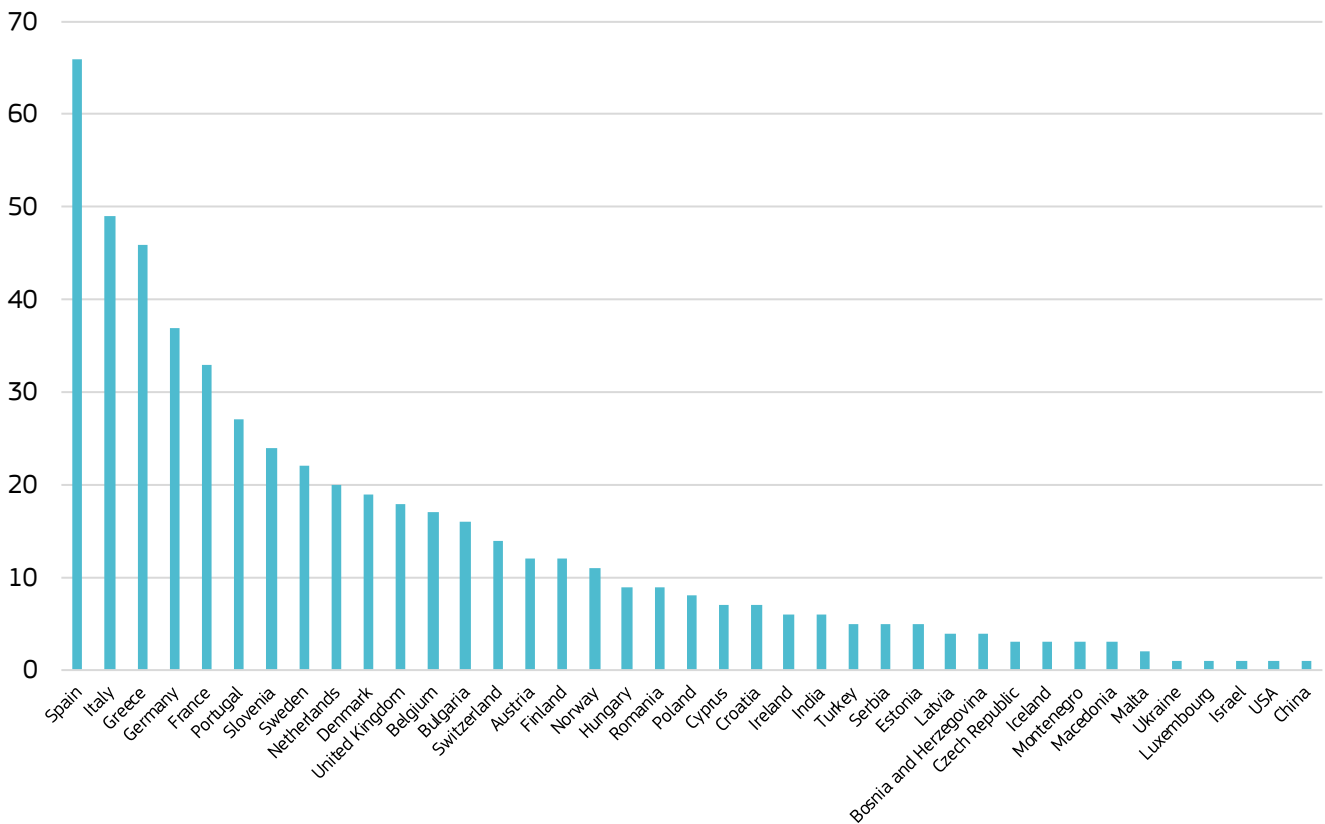



3.2.4 Number of demos or pilot sites per country

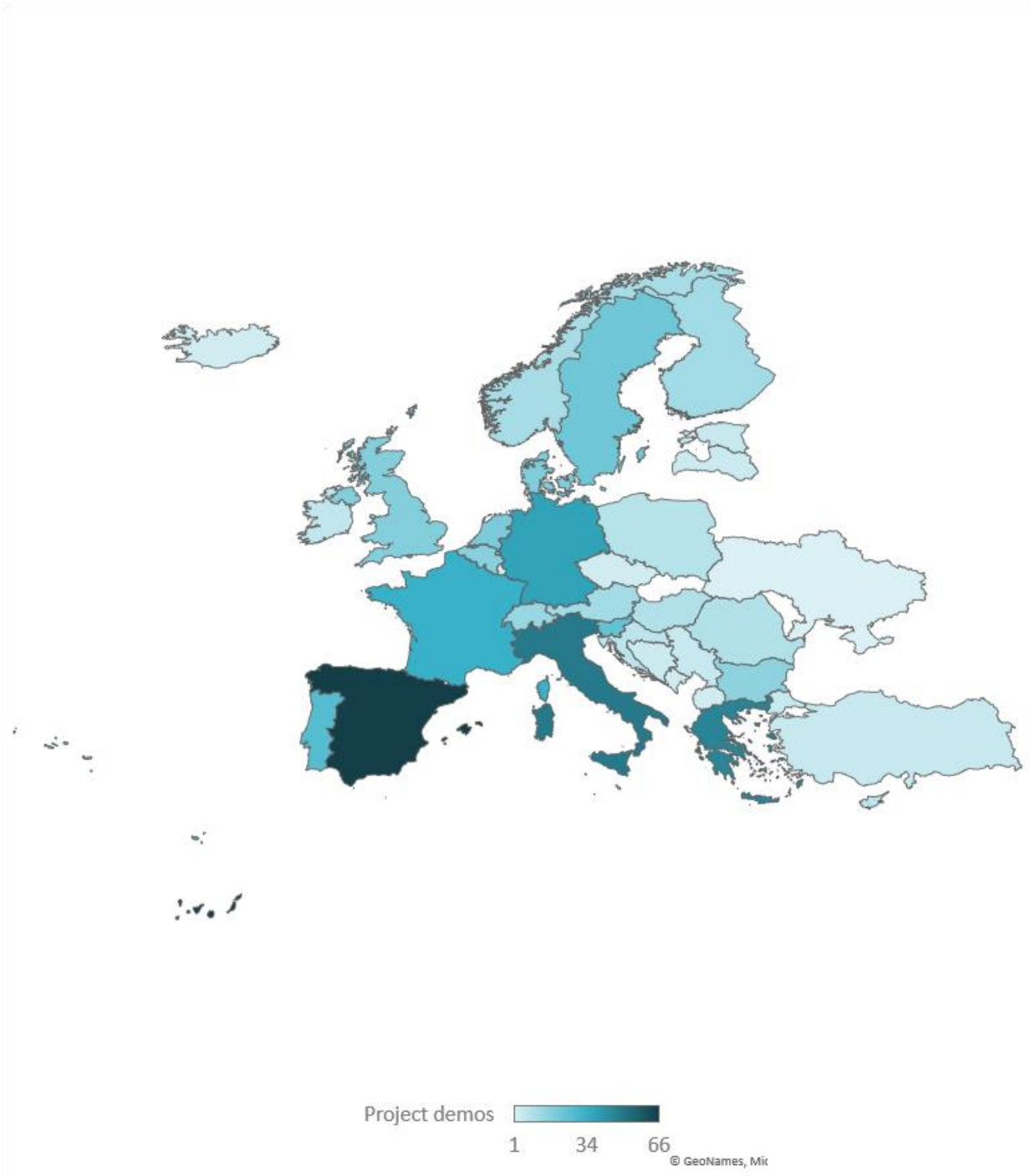

3.3 Technologies and services tackled by BRIDGE projects

A broad range of technologies and services are being tested by BRIDGE projects. We distinguished five main categories and we have introduced a new category called "Other" specifically for projects activities that did not align with any of the previously mentioned technologies. These activities have been assigned to the "Other" category for better organization:



Technologies for Consumers: demand response, smart appliances, smart metering, heating/cooling peak load management.



Grid technologies: HVDC, HVAC, multi-terminal (MT), protections, HVDC breaker, grid inertia, network management, monitoring and control tools¹, micro-grid, semiconductor devices and power converters.



Large-scale storage technologies (in general connected at **transmission level**²): power to gas (P2G), compressed air energy storage (CAES), hydro storage, and molten salt storage.



Small-scale storage technologies (in general connected at **distribution level**³): batteries, electric vehicles, thermal energy storage (including power to heat, heat pumps, hot water tanks, geothermal storage), and flywheels.



Generation technologies: wind turbines, photovoltaic (PV), solar thermal, biogas, tidal energy, micro-generation, floating offshore wind, floating offshore PV, Ocean thermal energy conversion (OTEC).



Other: recycling demonstration plant for EoL windmill blades, Ultra-High-Strength-Concrete precast components, innovative materials, Life cycle assessment (LCA), energy system modelling.

¹ Noted further on in Project fact sheets 'Network management and control tools'.

² It might happen however that such technologies, at a smaller scale, are connected at distribution level (in particular CAES).

³ Batteries might also be connected at transmission level.



The next figure indicates the number of BRIDGE projects deploying the six categories of technologies and services.

The distribution of technologies and services addressed by BRIDGE projects is presented on the graph below: the technology for consumers and small-scale storage technologies collectively account for 50% of the total, with each category covering 25%. Generation technologies encompass 23%, while grid technologies make up 22%. Large-scale storage technology represents 4%, and the emerging field of sustainable energy technologies and practices is covered in the sector Other 1%. This category involves activities of 4 new projects that did not fit in the previous categories, that is recycling demonstration plant for EoL windmill blades, Ultra-High-Strength-Concrete precast components, innovative materials, life cycle assessment (LCA), and energy system modelling.

DIGITALISATION and MARKET SERVICES

Digitalisation as enabling technology is dealing with technologies for consumers such as demand response or smart appliances and operation and management of the grid.

Moreover, a significant majority of BRIDGE projects, accounting for 66%, focus on the provision of electricity market services, encompassing market aspects and electricity markets. Furthermore, 62% of the projects place nearly equal emphasis on addressing ancillary services.

The following figures below show more specifically the exact distribution of the BRIDGE projects for each category of technologies or services.

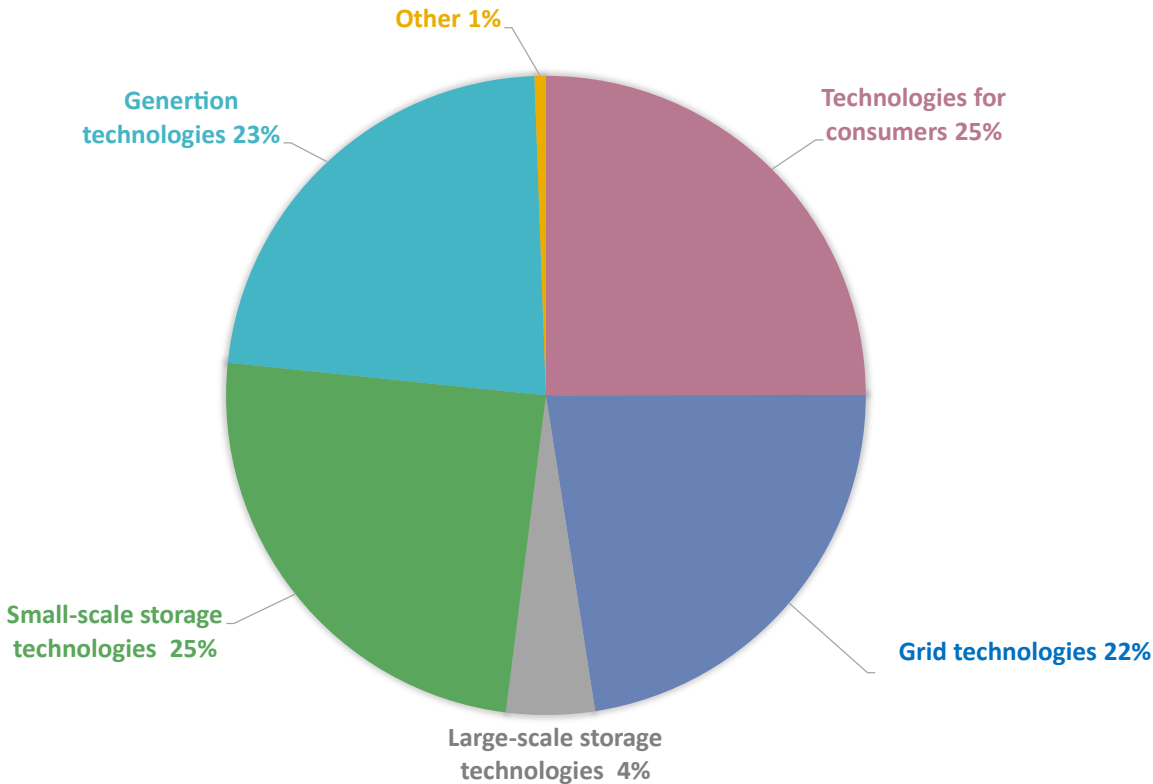



Technologies for consumers mainly address demand response (101) and smart metering (67); 49 projects also deal with smart appliances to be deployed at consumer level, and one projects addresses heating/cooling peak load management.

Technology for consumers

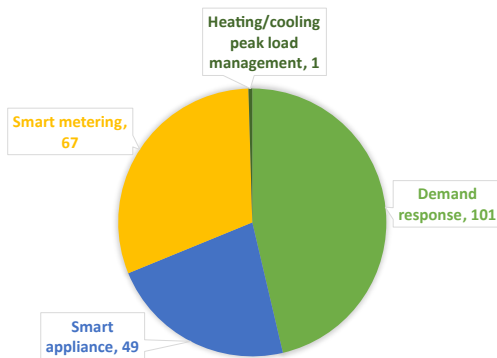

Among the grid technologies, a substantial portion of 45%, equivalent to 88 projects, is dedicated to the domain of network management, monitoring, and control tools. Within this group, 30% specifically focuses on the implementation of micro-grids.

Grid technologies

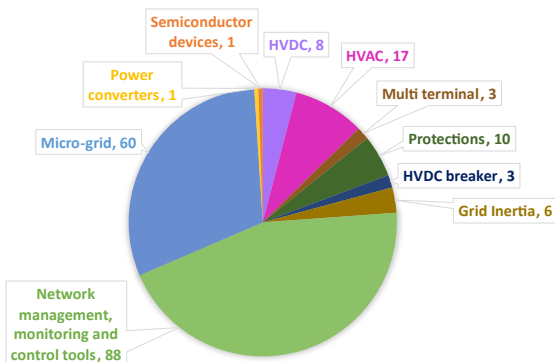

Regarding storage technologies, 14 projects work with power to gas, 6 projects with compressed air energy storage and 18 projects involve hydro storage and 1 project with molten salt energy.

Large-scale storage technologies

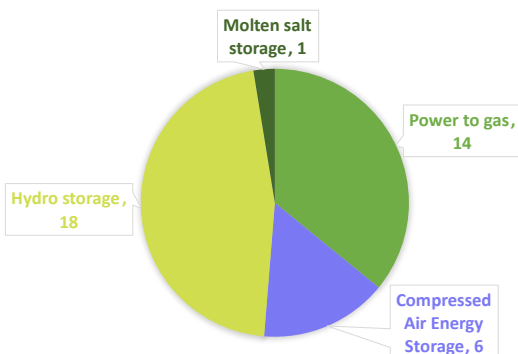

The BRIDGE community's primary focus on small-scale storage technologies is directed towards batteries, which are being explored in 82 projects, accounting for 60% of the total number of BRIDGE projects. Electric vehicles make up half of all the projects. Thermal energy storage is also highly regarded, accounting for approximately 42% of the projects. Additionally, flywheels are being evaluated in 8 projects, constituting around 6% of the total number of BRIDGE projects.

Small-scale storage technologies

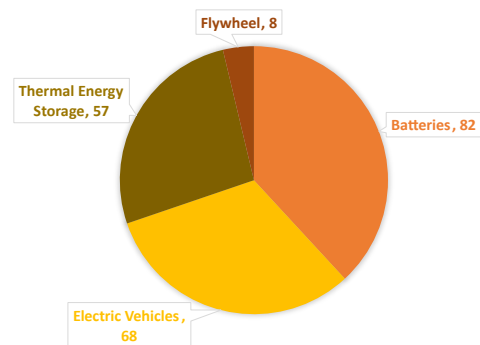

In terms of generation technologies, photovoltaic systems are addressed in 83 projects, accounting for 61% of the total number of BRIDGE projects. Wind turbine are being explored in 48 projects and micro-generation is 34, which consist of 35% and 25% of total BRIDGE projects, respectively. Other notable technologies mentioned include solar thermal (14 projects) and biogas (12 projects). Additionally, there are three emerging technologies covered by one project each, namely floating offshore photovoltaic (PV), floating offshore wind, and ocean thermal energy conversion (OTEC).

Generation technologies

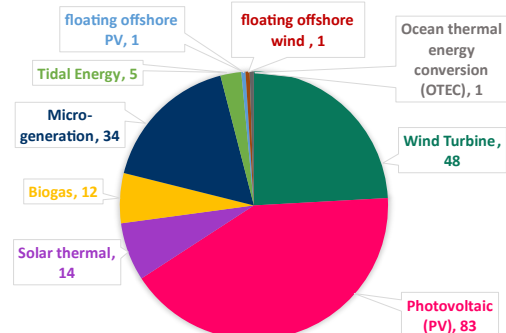



4 Horizon Europe, Horizon 2020 calls and Project fact sheets

4.1 Project fact sheets

The current section describes each project participating in the BRIDGE initiative. Projects are presented by call – easily identifiable by a colour – and for each call by alphabetical order.

Each project is presented over two pages:

- On the first page, a brief summary of the project is given, as well as the project timeline with a start and finish date, the budget, the website, the technologies and services deployed, the project partners' countries, the name of the coordinating organisation and of the other partners.
- The second page presents the project in detail, in terms of scope, technical description and expected impact.

4.2 Completed BRIDGE projects

Check the former versions of the BRIDGE Brochures to learn more about the 57 finished projects. These projects started between 2014-2016 and finished between 2017-2022.

Former BRIDGE Brochures:

[Brochure of BRIDGE projects 2020](#)

[Brochure of BRIDGE projects 2021](#)

4.3 Ongoing BRIDGE projects

[Click on the hyperlinks below to access the project fact-sheets!](#)

Use this link in each Fact sheet to return to the project list

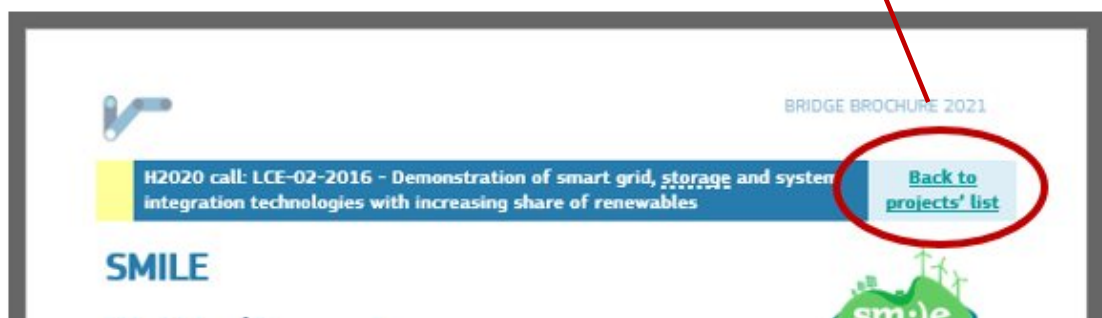

LC-SC3-ES-3-2018-2020 - Integrated local energy systems (Energy islands)

- [SERENE: Sustainable and Integrated Energy Systems in Local Communities of the energy systems](#)
- [LocalRES: Empowering local renewable energy communities for the decarbonisation of the energy systems](#)

LC-SC3-ES-1-2019 - Flexibility and retail market options for the distribution grid

- [ebalance-plus: Energy balancing and resilience solutions to unlock the flexibility and increase market options for distribution grid](#)
- [EUniversal: Market enabling interface to unlock flexibility solutions for cost-effective management of smarter distribution grids](#)
- [FEVER: Flexible Energy Production, Demand and Storage-based Virtual Power Plants for Electricity Markets and Resilient DSO Operation](#)
- [FLEXIGRID \(864579\): Interoperable solutions for implementing holistic FLEXibility services in the distribution GRID](#)
- [PLATONE: PLATFORM for Operation of distribution Networks](#)
- [X-FLEX: Integrated energy solutions and new market mechanisms for an eXtended FLEXibility of the European grid](#)

LC-SC3-ES-2-2019 - Solutions for increased regional cross-border cooperation in the transmission grid

- [FARCROSS: Facilitating Regional CROSS-border Electricity Transmission through Innovation](#)
- [TRINITY: TRansmission system enhancement of regioNal borders by means of IntellIgenT market technologY](#)

LC-SC3-ES-8-2019 - European Islands Facility - Unlock financing for energy transitions and supporting islands to develop investment concepts

- [NESOI: New Energy Solutions Optimized for Islands](#)

DT-ICT-10-2018-19 - Interoperable and smart homes and grids

- [InterConnect: Interoperable Solutions Connecting Smart Homes, Buildings and Grids](#)

DT-ICT-11-2019 - Big data solutions for energy

- [BD4OPEM: Big Data for OPen innovation Energy Marketplace](#)

- [PLATOON: Digital PLATform and analytic TOOlS for eNergy](#)
- [SYNERGY: Big Energy Data Value Creation within Synergetic energy-as-a-service applications through trusted multi-party data sharing over an AI big data analytics marketplace](#)
- [BD4NRG: Big Data for Next Generation Energy](#)

LC-SC3-EC-3-2020: Consumer engagement and demand response

- [ACCEPT: ACtive Communities & Energy Prosumers for the energy Transition](#)
- [BRIGHT: Boosting DR through increased community-level consumer engaGement by combining Data-driven and blockcHain technology Tools with social science approaches and multi-value service design](#)
- [HESTIA: Holistic dEmand response Services for European residenTIAL communities](#)
- [iFLEX: Intelligent Assistants for Flexibility Management](#)
- [REDREAM: Real consumer engagement through a new user-centric ecosystem development for end-users' assets in a multi-market scenario](#)
- [SENDER: Sustainable Consumer Engagement and Demand Response](#)
- [TwinERGY: Intelligent interconnection of prosumers in positive energy communities with twins of things for digital energy markets](#)

LC-SC3-ES-3-2018-2020: Integrated local energy systems (Energy islands)

- [CREATORS: CREATing cOmmunity eneRgy Systems](#)
- [eNeuron: Green Energy HUBs for Local IntegRATED Energy COmmunities optimisatioN](#)
- [REnergetic: Community-empowered Sustainable Multi-Vector Energy Islands](#)

LC-SC3-ES-10-2020 - DC – AC/DC hybrid grid for a modular, resilient and high-RES share grid development

- [HYPERRIDE: Hybrid Provision of Energy based on Reliability and Resiliency by Integration of Dc Equipment](#)
- [TIGON: Towards Intelligent DC-based hybrid Grids Optimizing the network performance](#)

LC-SC3-ES-4-2018-2020: Decarbonising energy systems of geographical Islands

- [IANOS IntegrATed SolutioNs for DecarbOnisation and Smartification of Islands](#)
- [ISLANDER: Accelerating the decarbonisation of islands' energy systems](#)



- [MAESHA: DeMonstration of smArt and fLExible solutions for a decarboniSed energy future in Mayotte and otHer European islAndS](#)
- [ROBINSON: smart integRation Of local energy sources and innovative storage for flexiBle, secure and cost-efficient eNErgy Supply ON industrialized islands](#)
- [VPP4ISLANDS: Virtual Power Plant for Interoperable and Smart isLANDS](#)

LC-SC3-ES-5-2020 - TSO-DSO cooperation

- [OneNet: One Network for Europe](#)

LC-SC3-ES-13-2020 - Integrated local energy systems (Energy islands): International cooperation with India

- [RE-EMPOWERED Renewable Energy EMPOWERing European and InDian communities](#)
- [SUSTENANCE SUSTainable ENergy system for Achieving Novel Carbon neutral ENergy communities](#)

HORIZON-CL5-2021-D3-01-01: Establish the grounds for a common European energy data space

- [Data Cellar Data hub for the Creation of Energy communities at Local Level and to Advance Research on them](#)
- [EDDIE - European Distributed Data Infrastructure for Energy](#)
- [ENERSHARE European transition from fossil fuels through data sharing](#)
- [OMEGA-X Orchestrating an interoperable sovereign federated Multi-vector Energy data space built on open standards and ready for GAia-X](#)
- [SYNERGIES Shaping consumer-inclusive data pathwaYs towards the eNErgy tRansition, through a reference Energy data Space implementation](#)

HORIZON-CL5-2021-D3-01-02: Laying down the basis for the demonstration of a Real Time Demonstrator of Multi-Vendor Multi-Terminal HVDC with Grid Forming Capability: Coordinated action

- [READY4DC Getting ready for multi-vendor and multi-terminal DC technology](#)

HORIZON-CL5-2021-D3-01-03 - Interoperability community

- [INT:NET Interoperability Network for the Energy Transition](#)

HORIZON-CL5-2021-D3-02-01: Demonstration of wave energy devices to increase experience in real sea condition

- [WEDUSEA Wave Energy Demonstration at Utility Scale to Enable Arrays](#)

HORIZON-CL5-2021-D3-02-05 Energy Sector Integration: Integrating and combining energy systems to a cost-optimised and flexible energy system of systems

- [SENERGY NETS Increase the Synergy among different ENERGY NETWORKS](#)
- [ELEXIA Demonstration of a digitized energy system integration across sectors enhancing flexibility and resilience towards efficient, sustainable, cost-optimised, affordable, secure and stable energy supply](#)
- [FEDECOM FEDERated -system of systems- approach for flexible and interoperable energy COMMunities](#)

HORIZON-CL5-2021-D3-02-06: Increasing energy system flexibility based on sector-integration services to consumers (that benefits system management by DSOs and TSOs)

- [BEFLEXible boosting engagement to increase flexibility](#)
- [ENFLATE ENabling FLExibility provision by all Actors and sectors through markets and digital TEchnologies](#)
- [STREAM Streaming Flexibility to the Power System](#)

HORIZON-CL5-2021-D3-02-07: Reliability and resilience of the grid: Measures for vulnerabilities, failures, risks and privacy

- [eFORT Establishment of a FramewORK for Transforming current EPES into a more resilient, reliable and secure system all over its value chain](#)
- [R2D2 Reliability, Resilience and Defense technology for the grid](#)

HORIZON-CL5-2021-D3-02-08: Electricity system reliability and resilience by design: High-Voltage, Direct Current (HVDC)-based systems and solutions

- [HVDC-WISE HVDC-based grid architectures for reliable and resilient WIdeSprEad hybrid AC/DC transmission systems](#)
- [NEWGEN New generation of HVDC insulation materials, cables and systems](#)

**HORIZON-CL5-2021-D3-02-09:****Demonstration of superconducting systems and elpipes**

- [SCARLET Superconducting Cables for sustainable Energy Transition](#)

HORIZON-CL5-2021-D3-02-10:**Demonstration of advanced Power Electronics for application in the energy sector**

- [AdvanSiC Advances in Cost-Effective HV SiC Power Devices for Europe's Medium Voltage Grids](#)
- [FOR2ENSICS Future Oriented Renewable and Reliable Energy SIC Solutions](#)
- [SiC4GRID Next Generation Modular SiC-Based Advanced Power Electronics Converters for Enhanced Renewables Integration into the Grid](#)

HORIZON-CL5-2021-D3-02-11: Reinforcing digitalisation related know how of local energy ecosystems

- [Every1 Enable eVeryone's Engagemet in the eneRgY transition.](#)

HORIZON-CL5-2021-D3-03-10: Innovative foundations, floating substructures and connection systems for floating PV and ocean energy devices

- [NATURSEA-PV novel eco-cementitious materials and components for durable, competitive, and bio-inspired offshore floating pv substructures](#)
- [PLOTEC PLOCAN Tested Optimised Floating Ocean Thermal Energy Conversion Platform](#)
- [SUREWAVE structural reliable offshore floating PV solution integrating circular concrete floating breakwater](#)

HORIZON-CL5-2021-D3-03-12: Innovation on floating wind energy deployment optimized for deep waters and different sea basins (Mediterranean Sea, Black Sea, Baltic Sea, North-east Atlantic Ocean)

- [BLOW Black sea fLloating Offshore Wind](#)
- [INFINITE INnovative oFfshore wInd techNologies in deep waTErs](#)
- [NEXTFLOAT Next Generation Integrated Floating Wind Optimized for Deep Waters](#)
- [WHEEL Wind Hybrid Evolution for Low-Carbon Solutions](#)

HORIZON-CL5-2021-D5-01-03: System approach to achieve optimised Smart EV**Charging and V2G flexibility in mass-deployment conditions (2ZERO)**

- [DriVe2X Delivering Renewal and Innovation to Mass Vehicle Electrification Enabled by V2X Technologies](#)
- [EV4EU Electric Vehicles Management for carbon neutrality in Europe](#)
- [FLOW Flexible energy systems Leveraging the Optimal integration of EVs deployment Wave](#)
- [XL-Connect Large scale system approach for advanced charging solutions](#)

HORIZON-CL5-2021-D5-01-04: LCA and design for sustainable circularity - holistic approach for zero-emission mobility solutions and related battery value chain (2ZERO & Batteries Partnership)

- [TranSensus LCA Towards a European-wide harmonised, transport specific LCA Approach](#)

HORIZON-CL5-2022-D3-01-02: Demonstration of innovative materials, supply cycles, recycling technologies to increase the overall circularity of wind energy technology and to reduce the primary use of critical raw materials

- [Blades2Build recycle repurpose and reuse end-of-life wind blade composites – a coupled pre- and co-processing demonstration plant](#)
- [EoLO-HUBs Wind turbine blades End of Life through Open HUBs for circular materials in sustainable business models](#)
- [REEFLEX REplicable, interoperable, cross-sector solutions and Energy services for demand side FLEXibility markets](#)
- [REFRESH Smart dismantling, sorting and REcycling of glass Fibre Reinforced composite from wind power Sector through Holistic](#)

HORIZON-CL5-2022-D3-01-07: Demonstration of innovative rotor, blades and control systems for tidal energy devices

- [MAXBlade Maximising tidal energy generation through Blade Scaling & Advanced Digital Engineering](#)

HORIZON-CL5-2022-D3-01-08: Supporting the action of consumers in the energy market and guide them to act as prosumers, communities and other active forms of active participation in the energy activities

- [MASTERPIECE Multidisciplinary Approaches and Software Technologies for Engagement,](#)



Recruitment and Participation in Innovative Energy Communities in Europe

- RESCHOOL Strategies and tOOls for Incentivization and management of flexibility in Energy Communities with distributed Resources
- COMMUNITAS Bound to accelerate the roll-out and expansion of Energy Communities and empower consumers as fully-fledged energy market players

HORIZON-CL5-2022-D3-01-09: Grid Forming Capability (in support of the offshore strategy)

- InterOPERA Enabling interoperability of multi-vendor HVDC grids

HORIZON-CL5-2022-D3-01-10: Interoperable solutions for flexibility services using distributed energy storage

- FlexCHESSE Flexibility services based on Connected and interoperable Hybrid Energy Storage System
- INTERSTORE Interoperable open-source Tools to Enable hybRidisation, utiliSation, and moneTisation of stORage fLExibility
- PARMENIDES Hybrid energy storage for electricity and heating

HORIZON-CL5-2022-D3-01-11: Demonstration of innovative forms of storage and their successful operation and integration into innovative energy systems and grid architectures

- 2LIPP 2nd Life for Power Plants
- AGISTIN Advanced Grid Interface for innovative Storage INtegration
- i-STENTORE innovative Energy Storage TEchnologies TOwards increased Renewables integration and Efficient Operation
- SINNOGENES storage innovations for green energy systems

HORIZON-CL5-2022-D3-01-12: Replicable solutions for a cross sector compliant energy ecosystem

- GLocalFlex A Global as well as Local Flexibility Marketplace to Demonstrate Grid Balancing Mechanisms through Cross-sectoral Interconnected and Integrated Energy Ecosystems enabling Automatic Flexibility Trading
- OPENTUNITY OPENing the electricity ecosystem to multiple actors in order to have a real decarbonization opporTUNITY
- RESONANCE Replicable and Efficient Solutions for Optimal Management of Cross-sector Energy

HORIZON-CL5-2022-D3-01-13: Energy system modelling, optimisation and planning tools

- MOPO Comprehensive, fast, user-friendly and thoroughly validated open-source energy system planning framework

HORIZON-CL5-2022-D3-01-14 Sustainable, secure and competitive energy supply

- BEST-Storage building energy efficient system through short and long spectrum thermal energy storage
- THUMBS UP Thermal energy storage solUTions to optimally Manage BuildingS and Unlock their grid balancing and flexibility Potential

HORIZON-CL5-2022-D3-01-14: Thermal energy storage solutions

- ECHO EFFICIENT COMPACT MODULAR THERMAL ENERGY STORAGE SYSTEM
- HYSTORE Hybrid services from advanced thermal energy storage systems



**H2020 call: LC-SC3-ES-3-2018-2020 - Integrated local energy systems
(Energy islands)**

[Back to projects' list](#)

SERENE

Sustainable and Integrated Energy Systems in Local Communities



The aim of the SERENE project is to develop and demonstrate sustainable, integrated, cost-effective and customer-centric solutions for local communities. The idea is to integrate different energy system carriers and new renewable generation units in the local communities based on their social and technical status today to meet their energy needs in the coming years. The users has to be involved in the changes of the energy system and be informed about different technical opportunities and business cases to make decisions about their participation. Depending on the actual site, the new energy system involve different storage technologies (battery energy storages, heat storages, water storage-systems), demand response systems to enhance the flexibility of the systems (activating for instance electric vehicle charging stations and heat demand supplies), electric transportation systems like electrical vehicles or buses, heating system improvements using heat-pumps and integration of new renewable generation sources mainly in form of photo voltaics.

From 2021 To 2025	Project total cost	EU contribution	Website
	5.7 M€	5.1 M€	https://h2020serene.eu/

Technologies and services deployed		Project partners' countries
	Technologies for consumers	
	Grid technologies	
	Distributed storage technologies	
	Generation technologies	
		<ul style="list-style-type: none"> Demand Response Smart appliance Smart metering HVAC Micro-grid Monitoring and control units Batteries Electric vehicles Thermal energy storage wind turbines PV Micro-cogeneration Solar Thermal Biogas

Coordinator	AALBORG UNIVERSITY AAU (DK)
--------------------	------------------------------------

Other partners:

- Skanderborg Municipality (DK)
- Aura Energi (utility company) (DK)
- Neogrid Technologies Aps. (DK)
- Suntherm Aps: SNT (DK)
- Bjerregaard Consulting Aps.: BJC (DK)
- Universiteit Twente (NL)
- Stichting Saxion:SAX (NL)
- Vereiniging Aardehuis Oost Nederland (NL)
- Loqio Services B.V. (NL)
- Gmina Przydwich: CCC (PL)
- Instytut Maszyn Preeplywowych im Roberta Swewalskiego Polskiej Akademii NA (PL)
- Energa Operato SA : (PL)
- STAY-ON Pawel Grabowsky (PL).



Project Description

Context. To accelerate the transition of the European electricity system to a more decentralized structure with local power production, the SERENE project aims to demonstrate -cost-effective and customer centric solutions for effectively integrating different energy system carriers for the sustainable development of regional communities to meet their energy needs from local energy renewable energy sources. This is realized by activating suitable locally available distributed generation, demand response resources and energy storage technologies in various energy domains like electricity, heat, water treatment and transport, and focusing on attractive citizen-centered business models and local economies. These activities shall enhance the flexibility and efficient operation of the local electricity grids and energy networks, and further contribute to the central energy infrastructures and grids.

Scope. The focus of the SERENE project is to establish a community-driven low carbon multi-carrier energy systems for smaller cities and villages. The main objective of SERENE is to demonstrate smart technological, socio-economic, institutional and environmental solutions to enable local management of integrated energy systems and networks, utilisation of high share of local renewable energy and active consumer engagement in real neighbourhoods across different countries (Denmark, Netherlands and Poland) and further leading to the market introduction and replicability on the innovations in other energy communities across Europa and beyond.

Technical description and implementation



SERENE approach to develop local integrated community energy islands

In each of the demonstrators of the SERENE project, two or more combinations of distributed energy resources and demand-side participation are integrated to supplement the existing local energy systems, based on its local requirements, conditions and characteristics, thereby formulating the pilot activities.

This leads to the achievement of a collective focus on establishing innovative actions to establish a common cross-domain framework for the integrated community-based smart energy management systems and set-ups that integrate and synergize the operation of local generation and flexible demand units across different energy sectors and markets. It coordinates different modules of intelligent demand side management and aggregation, optimal use and control of local generation resources and storage elements, data management and

automation, unit commitment and economic scheduling of all local units ensuring cheaper energy prices, and power management modules that maintain stability and reliability of the integrated energy system.

Impacts Replicability – market transformation – policy – socio-economic in Denmark-Netherlands-Poland.

1)Validate solutions for decarbonization of the local energy system while ensuring a positive impact on the wider energy infrastructure, on the local economy and local social aspects, and local air quality”.

2)Enhance the involvement of local energy consumers and producers, preferably by creating energy communities in the development and the operation of local energy systems and test new business models” across energy vectors (electricity, heating, cooling, water, wastes, etc.) so that it is able to integrate higher shares of renewables (than it would in case of separate operation of infrastructures)”

3)Benchmark technical solutions and business models that can be replicated in many local regions and that are acceptable by local citizens”

4)Enhancement of innovation capacity.

5)Create new market opportunities.

6)Strengthen competitiveness.

7)Growth of companies.

8)Address issues related to climate change and the environment



H2020 call: LC-SC3-ES-3-2018-2020 - Integrated local energy systems
(Energy islands)

[Back to projects' list](#)







LocalRES

Empowering local renewable energy communities for the decarbonisation of the energy systems



LocalRES will deploy innovative local energy systems driven by Renewable Energy Communities (REC) for a socially fair energy transformation that puts renewable energy into the hands of communities and people. LocalRES will deliver new digital tools that will boost the expected structural change in the current energy system at different levels: 1) generation, increasing the number of small power producers of renewable energy; 2) market, creating local energy markets that enable prosumers to trade energy volumes within local communities; 3) distribution, establishing a multidirectional energy flow and promoting REC driven energy services, and 4) consumers, empowering consumers to be active and participate in the energy system and the design of their own REC.

From 2019	Project total cost	EU contribution	Website
To 2022	7.1 M€	6.1 M€	TBD

Technologies and services deployed		Project partners' countries
 Technologies for consumers	Smart appliance Demand response Smart metering	
 Grid technologies	Micro-grid Network management Monitoring and control units	
 Large-scale storage technologies		
 Distributed storage technologies	Batteries Electric vehicles Thermal energy storage	
 Generation technologies	Micro-wind turbines PV Micro-cogeneration Biomass	

Coordinator	FUNDACION CARTIF (Spain)
--------------------	---------------------------------

Other partners:

- AIT AUSTRIAN INSTITUTE OF TECHNOLOGY GMBH (Austria)
- ARTELYS (France)
- CENTRICA BUSINESS SOLUTIONS BELGIUM (Belgium)
- FLEXENS OY AB (Finland)
- RINA CONSULTING SPA (Italy)
- DOWEL INNOVATION (France)
- ENERGY CITIES ASSOCIATION (France)
- ACCADEMIA EUROPEA DI BOLZANO (Italy)
- MUNSTER TECHNOLOGICAL UNIVERSITY (Ireland)
- TEKNOLOGIAN TUTKIMUSKESKUS VTT OY (Finland)
- KOKAR KOMMUN (Finland)
- R2M ENERGY SRL (Italy)
- COMUNE DI BERCHIDDA (Italy)
- EZE BARRIZAR KOOP ELK TXIKIA (Spain)
- AYUNTAMIENTO DE ISPASTER (Spain)
- FUNDACION TECNALIA RESEARCH & INNOVATION (Spain)
- SISTEMES AVANCATS D ENERGIA SOLAR TERMICA SCCL (Spain)
- UNIVERSITAT PASSAU (Germany)
- LAB10 COLLECTIVE EG (Austria)
- MARKTGEMEINDE OLLERSDORF IM BURGENLAND (Austria)



Project Description

Context. EU energy policy aims to deliver energy to consumers at affordable prices, enhance security of supply, and decarbonise the energy sector. According to the new Clean Energy Package (2018) consumers shall be entitled to have an active role in the EU energy system, leveraging on the possibilities offered by renewable energy. EU has set a target to reach a share of at least 27% renewables in final energy consumption by 2030, with half of the electricity coming from renewable energy sources (RES), while the electricity should be 100% carbon-free by 2050⁴. To achieve these objectives, most of this new RES capacity will continue to be deployed on the customer premises at local level, while a fully market-integration should be ensured to meet affordable energy prices.

Scope. the main focus of LocalRES is on Renewable Energy Communities (RECs) as main actors to lead the structural change towards the decarbonisation of the local energy systems through the involvement and awareness-raising of citizens and communities.

Technical description and implementation. LocalRES will develop a planning tool oriented to enable citizen participation in the REC planning decision-making processes and will allow to maximize the replicability and scalability potential of the decentralized solutions developed in the project.

LocalRES will also develop and demonstrate at TRL8 a Multi-Energy Virtual Power Plant (MEVPP) approach to optimize in real-time different energy vectors and different energy and flexibility services by the REC, according to their community preferences. The MEVPP will maximize the RES contribution, enhance the energy system flexibility and supply security.

The LocalRES solutions will promote a secure, sustainable, competitive and affordable energy supply for everyone.

Impact Replicability: LocalRES solutions for the decarbonisation of local energy systems will be showcased in replicability workshops to trigger the creation of new RECs across EU. Lessons learnt during the demonstration actions will be used for policy recommendations.

Socio-economics: LocalRES develops and demonstrates digital tools (planning tool and control based on Multi Energy Virtual Power Plant) to enhance the creation and the management of Renewable Energy Communities via a participatory approach, thereby involving the whole socio-technological energy system value chain.

Environment: LocalRES solutions will support the acceleration of the local energy transition and decarbonisation of local energy systems.

Market Transformation: Local energy markets will be created that enable prosumers to trade energy volumes of their choice within local communities.

Policy: Following the new Clean Energy Package (2018), LocalRES envisions a new energy system totally decentralized where electricity, H&C and mobility become increasingly interconnected. In a truly complementary approach, LocalRES will contribute to integrate the EU top-down energy and climate policy mechanisms with a bottom-up approach that aims to promote decarbonisation of the local energy system.



4 [https://www.europarl.europa.eu/RegData/etudes/BRIE/2019/631047/IPO_L_BRI\(2019\)631047_EN.pdf](https://www.europarl.europa.eu/RegData/etudes/BRIE/2019/631047/IPO_L_BRI(2019)631047_EN.pdf)



H2020 call: LC-SC3-ES-1-2019 - Flexibility and retail market options for the distribution grid

[Back to projects' list](#)







ebalance-plus

Energy balancing and resilience solutions to unlock the flexibility and increase market options for distribution grid



ebalance-plus develops an energy management platform equipped with balancing and resilience services which increase and unlock the electric flexibility by means of generation and storage solutions, power electronics and grid control technologies, to provide ancillary services for new markets.

From 2020	Project total cost	EU contribution	Website
To 2023	9.5 M€	8.0 M€	http://www.ebalanceplus.eu/

Technologies and services deployed		Project partners' countries
 Technologies for consumers	Demand response Smart metering	
 Grid technologies	Network management and control tools Micro-grid	
 Large-scale storage technologies		
 Distributed storage technologies	Batteries Electric Vehicle Thermal energy storage	
 Generation technologies	PV	
 Market	Electricity Market Ancillary Services	
Coordinator	CENTRO DE ESTUDIOS DE MATERIALES Y CONTROL DE OBRA SA (SPAIN)	

Other partners:

- IHP GMBH - INNOVATIONS FOR HIGH PERFORMANCE MICROELECTRONICS/LEIBNIZ-INSTITUT FUER INNOVATIVE MIKROELEKTRONIK (Germany)
- OSRODEK PRZETWARZANIA INFORMACJI-PANSTWOWY INSTYTUT BADAWCZY (Poland)
- AMPERE POWER ENERGY SL (Spain)
- UNIVERSIDAD DE MALAGA (Spain)
- SOFTWARE FOR CRITICAL SYSTEMS SL (Spain)
- REENGEN ENERJI TEKNOLOJILERI ANONIM SIRKETI (Turkey)
- TURBO POWER SYSTEMS LTD (United Kingdom)
- EMTECH DIASTIMIKI MONOPROSOPI IDIOTIKI ETAIREIA (Greece)
- MAGNUM CAP - ELECTRICAL POWER SOLUTIONS LDA (Portugal)
- UNIVERSITA DELLA CALABRIA (Italy)
- YNCREA HAUTS DE FRANCE (France)
- DANMARKS TEKNISKE UNIVERSITET (Denmark)
- ENFOR AS (Denmark)
- EUROPEAN SCIENCE COMMUNICATION INSTITUTE (ESCI) GGMBH (Germany)



Project Description

Context. In 2018, the EC presented the long-term strategy to achieve a low carbon neutral economy by 2050. It was focused on a **fully-integrated internal energy market aiming at:** (i) allowing EU free energy flows without technical and legal barriers, (ii) promoting renewable energy sources (RES) and other efficient technologies, (iii) proposing new EU Directives to transform the energy market and (iv) empowering energy consumers. This context requires increasing the number of electric substations with monitoring and control devices as well as developing cost-effective storage system and smart solutions to engage consumers in energy issues and promoting new market models.

Scope. ebalance-plus develops an ICT Energy Management Platform (EMP) to integrate and demonstrate a variety of solutions in 4 different energy market frameworks (Spain, Italy, France and Denmark) with specific technical challenges. The goal is to unlock the energy flexibility and provide ancillary services that improve the grid resilience and open new market options regarding energy aggregators, communities and cooperatives. The EMP is based on a hierarchical architecture of Management Units (MU), where each level is related to the electricity domains of the standard Smart Grid Architecture Model (SGAM): customer, DER, distribution and transmission. Every MU integrates a set of balancing algorithms and prediction models to coordinate the MU located at the immediate lower level in the hierarchical structure. The EMP guarantees interoperability: it allows deploying new flexibility solutions (storage, IoT, V2G, district RES, power-to-heat...) based on a common data exchange format and integrating it into existing Building Automation Systems (BACS) to operate technical facilities and appliances according to the grid and market conditions. Furthermore, the solution is designed following user centric approaches, including social studies in the design of appealing and engaging end user interfaces (mobile app).

Technical description and implementation. The MU is developed and integrated at building and grid level. The Customer Management Unit at building level (CMU) will control the smart appliances, IoT devices and technical facilities through BACS. At grid level, three MU will be developed for: the Distributed Energy Resources (DERMU), secondary (LVGMU) and primary (MVG MU) substations. The grid management units increase the system observability and improve its control capabilities. Besides, ebalance-plus develops and test a variety of technologies in different demo sites: (1) smart-batteries (Li-ion) for large buildings; (2) high-efficient power inverters based on silicon carbide (SiC) transistors that enable DC networks; (3) vehicle-to-grid (V2G) charging points for DC networks and PV generation; (4) IoT devices to integrate smart-appliances and technical facilities; and (5) user-friendly mobile app to engage end-customers in demand response services.

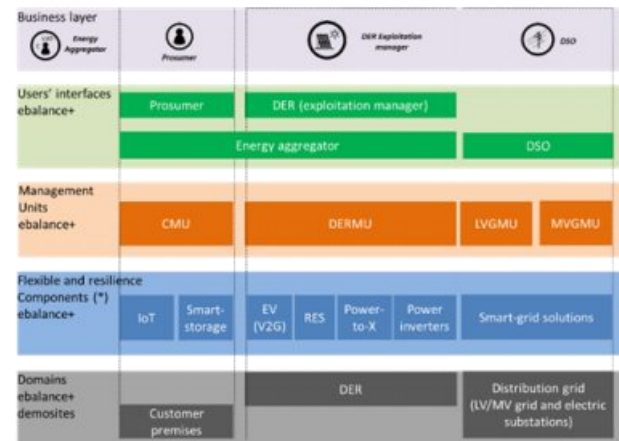

Impact. Replicability: ebalance-plus solution is based on the concept of MU's which are scalable and replicable in a hierarchical architecture. Scalability and replicability are at the core of this project concept. Besides, the variety of energy solutions tested different market contexts will boost the replicability chances.

Socio-economics: ebalance-plus will empower customers with further information about their energy costs and friendly end-user interfaces. It will also increase the new markets flexibility potential transparency. As a result, the potential end-user acceptance is high.

Environment: ebalance-plus allows integrating RES and power-to-heat facilities in the electric grid and facilitates its control for an optimal grid operation which reduces power peaks and power losses and thus, carbon emissions.

Market Transformation: ebalance-plus quantify and manage the available and foreseen energy flexibility of buildings and other grid facilities, enabling ancillary services that can impact most of electricity stakeholders (energy suppliers, aggregators, DSO, among others).

Policy: The demonstration in 4 real sites and countries with different regulations, market frameworks and customer behaviours will support the development of new policies and provide tools to motivate the role of new energy aggregators, communities and cooperatives.



H2020 call: LC-SC3-ES-1-2019 - Flexibility and retail market options for the distribution grid

[Back to projects' list](#)

EUniversal

Market enabling interface to unlock flexibility solutions for cost-effective management of smarter distribution grids



EUniversal aims at implementing the Universal Market Enabling Interface (UMEI) concept by bringing forward a universal, open, adaptable and modular approach to interlink active system management with electricity markets and foster the provision of flexibility services, also acknowledging the activation needs and the coordination requirements with other commercial parties and TSOs. A set of market-oriented flexibility services from DERs will be implemented to answer DSOs' needs in a cost-effective way.

From 2020	Project total cost	EU contribution	Website
To 2023	9.8 M€	7.9 M€	https://euniversal.eu/

Technologies and services deployed		Project partners' countries
	Technologies for consumers	
	Grid technologies	
	Large-scale storage technologies	
	Distributed storage technologies	
	Generation technologies	
	Market	
		<ul style="list-style-type: none"> Demand response Smart Appliance Smart Metering HVAC Inertia Micro-grid Network management and control tools Batteries Electric Vehicles Thermal energy storage Wind Turbine PV Micro-generation Electricity market Ancillary services

Coordinator

EDP DISTRIBUICAO ENERGIA SA (PORTUGAL)

Other partners:

- INNOGY SE (Germany)
- ENERGA OPERATOR SA (Poland)
- EUROPEAN DISTRIBUTION SYSTEM OPERATORS FOR SMART GRIDS (Belgium)
- EUROPEAN ASSOCIATION FOR STORAGE OF ENERGY (Belgium)
- INESC TEC - INSTITUTO DE ENGENHARIA DE SISTEMAS E COMPUTADORES, TECNOLOGIA E CIENCIA (Portugal)
- THE UNIVERSITY OF MANCHESTER (United Kingdom)
- UNIVERSIDAD PONTIFICIA COMILLAS (Spain)
- VLAAMSE INSTELLING VOOR TECHNOLOGISCH ONDERZOEK N.V. (Belgium)
- TRACTEBEL IMPACT BELGIUM SA (Belgium)
- N-SIDE (Belgium)
- NODES AS (Norway)
- CENTRICA BUSINESS SOLUTIONS BELGIUM (Belgium)
- INSTYTUT ENERGETYKI (Poland)
- MIKRONIKA SPOLKA Z OGRANICZONA ODPOWIEDZIALNOSCIA (Poland)
- KATHOLIEKE UNIVERSITEIT LEUVEN (Belgium)
- VLERICK BUSINESS SCHOOL (Belgium)
- ZABALA INNOVATION CONSULTING, S.A. (Spain)



Project Description

Context. The present context shows the potential of electricity grids to lead the energy system transition as new solutions deal with the challenges related to flexibility, grid observability and controllability, market mechanisms and interoperability in a holistic way. The new solutions need to cover the technological aspects by linking smart and integrated services and tools for distribution grid with market mechanisms. This architecture will guarantee a significant impact on the environment and society, putting consumers at its centre.

Scope. EUniversal enables the transformation of the electricity grid by overcoming existing limitations in the use of flexibility by DSOs through the implementation of a Universal Market Enabling Interface (UMEI). To achieve this vision, EUniversal relies on the following key elements:

- Bringing forward a universal, open, adaptable and modular approach to interlink active system management with electricity markets and foster the provision of flexibility services, also acknowledging the activation needs of and the coordination requirements with other commercial parties and TSOs.
- A set of market-oriented flexibility services from DERs will be implemented to answer DSOs' needs in a cost-effectively way, supporting the energy transition.
- Three heterogeneous groups of pilot demonstrators in three different countries have been selected to cover a broad range of distribution grid typologies and to test the solutions in distinct regulatory environments and in alignment with national plans for the energy transition in 2030.

Technical description and implementation. UMEI concept relies on the following four structural pillars:

- Universal Market Enabling Interface (UMEI);
- Flexibility enabling technologies and solutions;
- Smart Grid Solutions;
- Flexibility market mechanisms, products and platforms.

EUniversal develops a fully interoperable, adaptive, evolutive, technology neutral and replicable DSO interface for flexibility services providers, enabling the standard provision of flexibility and the uptake of existing and new market solutions. While developing a flexibility toolbox, the project aims to revise DSO smart grid management and the control paradigm for enabling the integration of new market mechanisms and flexibility services as new assets for network planning, operation and automation schemes. Innovative market mechanisms for the procurement and activation of a selection of grid services for DSOs are designed and assessed, led by the increase of the options to operate the distribution grid in a secure and stable manner at an affordable cost through the use of flexibility from DERs. Three DEMO sites (PT, DE, PL) are monitored.

Impact. *Replicability:* EUniversal allows increase in RES and DERs' hosting capacity of more than 50% as well as of energy storage solutions' penetration, through more than 6 standardised flexibility services for distribution grids provided by DERs, storage, microgrids or energy communities, through UMEI standard, in different

regulatory/ grid contexts. It enables 60% of SAIDI and SAIFI improvement using novel methodology for including distribution grid resilience metric in planning and operation; grid investment avoidance or deferral due to the use of flexibility (>30%); reinforcement of Resilience and Flexibility to Extreme Events (40%).

Socio-economics: EUniversal empowers energy consumers and contributes to job creations.

Environment: EUniversal solutions allows a GHG emissions reduction until 40% and enable an increase of at least +32% of the share of renewables

Market Transformation: EUniversal improves infrastructure (strengthening the grids); fosters digitalisation; contributes to an extensive business process transformation, necessary to overcome the new challenges and to capitalise on investments in smart technology. The project offers a relatively fast market introduction of new solutions for grid operators and market parties.

Policy: EUniversal supports:

- the development of new approaches for distribution planning and operation including flexible resources;
- the implementation of incentives for DSOs to procure flexibility from network users;
- the TSO-DSO coordination;
- the role of DSOs in emerging business models;
- the customers access to the energy markets to trade their flexibility and self-generated electricity.

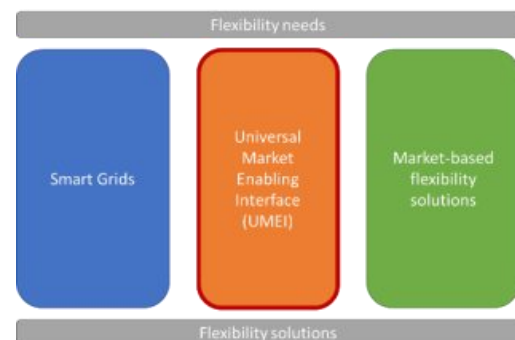



H2020 call: LC-SC3-ES-1-2019 - Flexibility and retail market options for the distribution grid

[Back to projects' list](#)







FEVER

Flexible Energy Production, Demand and Storage-based Virtual Power Plants for Electricity Markets and Resilient DSO Operation



FEVER aims at implementing and demonstrating solutions and services that leverage flexibility towards offering electricity grid services that address problems of the distribution grid, thus enabling it to function in a secure and resilient manner. The project encompasses technologies and techniques for extraction of energy flexibility from virtual and physical energy storage assets (batteries, V2G) and demand response. FEVER's holistic approach to flexibility will facilitate establishing and operating appropriate business models for all players in the market, thereby providing the EU with a secure, efficient, and resilient electric grid.

From 2020 To 2023	Project total cost	EU contribution	Website
	10 M€	7.8 M€	www.fever-h2020.eu

Technologies and services deployed		Project partners' countries
 Technologies for consumers	Demand Response	
 Grid technologies	Network management and control tools	
 Large-scale storage technologies		
 Distributed storage technologies	Batteries Electric Vehicles Thermal energy storage	
 Generation technologies		
 Market	Electricity market Ancillary services	

Coordinator	Intracom Telecom (GREECE)
--------------------	----------------------------------

Other partners:

- UNIVERSITY OF CYPRUS (Cyprus)
- PANEPISTIMIO PATRON (Greece)
- INEA INFORMATIZACIJA ENERGETIKA AVTOMATIZACIJA DOO (Slovenia)
- ESTABANELL Y PAHISA ENERGIA SA (Spain)
- ESTABANELL Y PAHISA MERCATOR SA (Spain)
- UNIVERSITAT DE GIRONA (Spain)
- UNIVERSITE CATHOLIQUE DE LOUVAIN (Belgium)
- UNIVERSITAT POLITECNICA DE CATALUNYA (Spain)
- SWW WUNSIEDEL GMBH (Germany)
- ELLINIKO HRIMATISTIRIO ENERGEIAS (Greece)
- B.A.U.M. CONSULT GMBH (Germany)
- AALBORG UNIVERSITET (Denmark)
- STADTWERK HASSFURT GMBH (Germany)
- ES-GEHT!-ENERGIESYSTEME GMBH (Germany)
- IBM IRELAND LIMITED (Ireland)
- FLEXSHAPE APS (Denmark)



Project Description

Context. Electricity grids are planned, operated and controlled to provide an economical, safe and reliable supply. In this context the reliability considers only the most likely events. Extreme climate events are mostly not considered in the typical grid planning phase, but also need to be taken into account for in grid operation, via appropriate automation and control strategies. Active Distribution Networks (ADNs) have the potential to improve the distribution system reliability and resiliency by leveraging new tools that offer intelligent functions. ADNs may also leverage flexibility as a service to overcome critical events.

Scope. FEVER's scope is defined by three axes. First, to develop and demonstrate solutions and innovative services that leverage flexibility towards offering electricity grid services that address problems of the distribution grid, enabling it to function in a secure and resilient manner in light of the ever-expanding penetration of distributed variable renewables. These solutions will incorporate established and emerging technologies among others related to demand response, distributed storage (stationary and EVs), and power electronics. Second, to enhance advanced monitoring and automated control of the distribution grid, supporting functions related to continuity of supply, operation restoration, and power quality monitoring. Third, to analyze and demonstrate novel market mechanisms and tools that support and incentivize flexibility services, taking into account the policy context and market rules.

The envisaged solutions will allow DSOs to better plan, build, monitor, control and safely operate their grid, while creating business opportunities for stakeholders such as the Prosumers and Flexibility Aggregators.

Technical description and implementation.

FEVER will implement:

- flexibility measures that address the local needs for flexibility at the distribution grid, leveraging flexibility assets such as residential and industrial loads, EVs, stationary batteries, as well as the potential for flexibility due to the electrification of various sectors, such as heating and cooling
- a comprehensive flexibility aggregation, management and trading solution that incorporates intelligence around the optimal flexibility orchestration (both with technical and economic criteria) and is capable to offer flexibility services in different markets (local, peer-to-peer, wholesale)
- electricity grid services such as congestion management and overvoltage avoidance based on flexibility management techniques such as EVs' (dis)-charging control
- an innovative toolbox that empowers the DSOs with advanced monitoring and automated control functions
- an advanced technology that leverages batteries' inverters towards providing ancillary services
- a hierarchical and scalable operational mechanism for day-ahead and continuous trading of flexibility services

- a toolbox for peer-to-peer flexibility trading based on decentralized ledger technologies (DLTs).
- an innovative combined automated trading that also leverages the DLTs toolbox to realize complex business models in closed systems such as local energy communities.



Impact. Replicability: Contribute to define the conditions of a well-functioning electricity market which creates business case for stakeholders willing to provide such flexibility and allow to sustain the necessary investments (e.g. variable price strategies).

Socio-Economics: (i) Improve the capability to manage future energy loads including electrical vehicles. (ii) Improve distribution grid operations which guarantee security of supply and the use of flexibility products while integrating large shares of variable renewables avoiding unnecessary investments by solving congestion.

Environment: Decarbonizing the economy.

Market transformation: (i) Increased resiliency of the electricity grid – increased system security. (ii) Improving innovation capacity, creating new market opportunities, strengthening competitiveness and growth of companies and integrating new knowledge.

Policy: Alignment with the EU policy.



H2020 call: LC-SC3-ES-1-2019 - Flexibility and retail market options for the distribution grid

[Back to projects' list](#)







FLEXIGRID (864579)

Interoperable solutions for implementing holistic FLEXibility services in the distribution GRID



FLEXIGRID improves the distribution grid operation making it more flexible, reliable and cost-efficient through the development of 8 solutions interoperable with the IT systems used by the energy stakeholders.

From 2019	Project total cost	EU contribution	Website
To 2023	8.5 M€	6.8 M€	www.flexigrid-h2020.eu

Technologies and services deployed		Project partners' countries
	Technologies for consumers	
	Grid technologies	
	Large-scale storage technologies	
	Distributed storage technologies	
	Generation technologies	
	Market	
	<ul style="list-style-type: none"> Demand Response Smart metering HVAC Protections Network management and control tools Micro-grid Batteries Electric Vehicles Thermal Energy Storage PV Micro-generation Electricity market Ancillary services 	

Coordinator

FUNDACION CIRCE CENTRO DE INVESTIGACION DE RECURSOS Y CONSUMOS ENERGETICOS (Spain)

Other partners:

- VIESGO DISTRIBUCION ELECTRICA SL (Spain)
- ELIN VERD ANONYMI ETAIRIA AEIFORONPROIONTON KAI YPIRESION (Greece)
- HEP-OPERATOR DISTRIBUCIJSKOG SUSTAVA DOO ZA DISTRIBUCIJU I OPSKRBU ELEKTRICNE ENERGIJED.O.O. (Croatia)
- EDYNA SRL (Italy)
- ORMAZABAL PROTECTION AND AUTOMATION SL (Spain)
- ZIV APLICACIONES Y TECNOLOGIA SL (Spain)
- SELTA SPA (Italy)
- ATOS SPAIN SA (Spain)
- IOANNIS SARANTIS-TOURISTIKAI-XENODOCHEIAKAI-KTIMATIKAI-TECHNIKAI KAI GENIKAI EPICHEIRISEIS ANONYMOS ETAIRIA (Greece)
- HYPERTECH (CHAIPEKTEK) ANONYMOS VIOMICHANIKI EMPORIKI ETAIREIA PLIROFORIKIS KAI NEON TECHNOLOGION (Greece)
- UNIVERSIDAD DE CANTABRIA (Spain)
- SVEUCILISTE U ZAGREBU FAKULTET ELEKTROTEHNIKE I RACUNARSTVA (Croatia)
- FONDAZIONE LINKS - LEADING INNOVATION & KNOWLEDGE FOR SOCIETY (Italy)
- CAPENERGIES ASSOCIATION (France)
- CONFEDERATION EUROPEENNE DES DISTRIBUTEURS PUBLICS CUMMUNAUX D ENERGIE (Belgium)



Project Description

Context. The main goal of FLEXIGRID is to allow the distribution grid to operate in a secure and stable manner when a large share of variable generation electricity sources is connected to low and medium voltage grids. To do so, FLEXIGRID proposes a three-level approach aiming at (1) Flexibility, (2) Reliability, and (3) Economic Efficiency through the development of innovative hardware and software solutions. These solutions will be demonstrated in four Demo-Sites across Europe ensuring their interoperability through its integration into an open source platform able to harmonize the data flow between FLEXIGRID solutions and the real grid.

Scope. FLEXIGRID project is focused on:

- Improving the power system flexibility by enhancing the grid hosting capacity of RES towards the energy network decarbonization.
- Increasing the observability, controllability and automation of the network systems for the improvement of both the security and resilience of the grid.
- Mitigation of congestions in the distributed grid thus reducing the cost of the European energy transition.
- Ensuring the interoperability and compatibility of the developed solutions with the different platforms used by the European DSOs guaranteeing a proper and secure data management.
- Demonstrating program up to TRL 8 in four different demo-sites, obtaining reliable results on its replicability and ensuring its attractiveness for European stakeholders.
- Identifying and analysing the needs and shortfalls of the distribution grid as well as the obstacles to innovation under the current local and international context and regulation framework
- Raising awareness among citizens and stakeholders of the transition towards a low carbon economy considering them as an active player in the energy system
- Ensuring the exploitation of the project results by a corresponding business plan as well as their dissemination by exchanging knowledge with other projects under the BRIDGE Initiative.

Technical description and implementation. FLEXIGRID aims to demonstrate a set of hardware and software solutions to enhance the flexibility, observability and resilience in four European distribution grids with very different characteristics. These solutions include, among other developments, the SS of the future, a new generation of smart meters and protection schemes and several modules and services for forecasting, fault detection, self-healing, congestion management and demand response. All these solutions are focused on guaranteeing the security and stability of the distribution grid in scenarios with high rates of renewables avoiding large investments in infrastructure. The success of such an ambitious project requires a clear and well-defined methodology:

Data gathering and demo-sites characterization, ICT architecture and CIM definition, Technological

developments, FUSE platform development and integration, Validation and demonstration, Results gathering, Overall impact analysis and Definition of replication strategy.

Impact. *Replicability:* The demo-sites selected in FLEXIGRID covers a comprehensive scenario of distribution grids' topologies available in Europe offering a high replicability potential.

Socio-economics: Doubling the share of renewables increases direct and indirect employment in the sector. Renewable energy jobs will grow across all technologies. Additionally, the solutions developed based on the improvement of distribution network control allow to achieve reductions of the reinforcement of interconnections and investments needed to maintain the quality and stability of the grid.

Environment: FLEXIGRID's solutions allow renewable energies curtailments decrease thanks to the improvement of the observability and control over the grid, at the same time that contribute to make energy grids more sustainable, flexible and reliable. This contribute significantly to achieve CO2 emissions savings due to the larger penetration of share RES, contributing to the 2030 Climate-Energy objectives.

Market Transformation: FLEXIGRID covers the whole spectrum of many items included in the EU policy and market trends regarding the improvement of distribution networks.

Policy: FLEXIGRID intends to provide recommendations on new policy developments and regulations at regional and EU level. The project outputs aim to impact on specific articles of the Directive regarding the ownership and the operation of flexibility solutions by the market and regulated players, others relative to the new regulatory environment for DSO, and others regarding the new regulatory environment for distribution system operator



H2020 call: LC-SC3-ES-1-2019 - Flexibility and retail market options for the distribution grid

[Back to projects' list](#)

Platone

PLATform for Operation of distribution Networks



Platone aims at developing a layered set of platforms to meet the needs of system operators, aggregators and end users. A blockchain-based platform is the access layer to generators' and customers' flexibilities able to break traditional access barriers by providing certified measures to all the players. In conjunction, certified data and signals are used for an innovative DSO platform to locally maintain system integrity fostering confidence in flexibility operations. An upper layer implements a new concept of blockchain-based open market platform to link the local system to the TSO domains and enhance the overall system cost efficiency. The platforms are tested in three large pilots in Europe and analysed in cooperation with a large research initiative in Canada.

From 1/09/2019	Project total cost	EU contribution	Website
To 31/08/2023	9.6 M€	7.5 M€	https://www.platone-h2020.eu

Technologies and services deployed	Project partners' countries
Technologies for consumers Grid technologies Large-scale storage technologies Distributed storage technologies Generation technologies Market	Smart appliance Network management and control tools Electricity Market

Coordinator RHEINISCH-WESTFAELISCHE TECHNISCHE HOCHSCHULE AACHEN (Germany)

Other partners:

- RICERCA SUL SISTEMA ENERGETICO - RSE SPA (Italy)
- EUROPEAN DISTRIBUTION SYSTEM OPERATORS FOR SMART GRIDS (Belgium)
- ACEA ENERGIA SPA (Italy)
- SIEMENS SPA (Italy)
- APIO S.R.L. (Italy)
- ARETI S.P.A. (Italy)
- DIACHEIRISTIS ELLINIKOU DIKTYOU DIANOMIS ELEKTRIKIS ENERGEIAS AE (Greece)
- NATIONAL TECHNICAL UNIVERSITY OF ATHENS - NTUA (Greece)
- B.A.U.M. CONSULT GMBH (Germany)
- AVACON NETZ GMBH (Germany)
- ENGINEERING - INGEGNERIA INFORMATICA SPA (Italy)



Project Description

Context. As the Energy System becomes dominated by renewable energy sources, customers become key players through their generation assets and the flexibility in their load operation. Platone aims at creating unique synergies between market and operation developing a multi-layer platform for customer integration into network operation.

Scope. Platone provides a seamless integration of operation and market, simplifying the life of customers, distribution grid operator and aggregators. A multilayer platform architecture collects data on the edge and delivers secure information both to distribution management systems and to an open marketplace for service provision. Platone intends to create a mechanism to link the edge structure with the DSO operation both for flexibility marketing and grid management, creating a unique synergy in data acquisition and management.

Technical description and implementation. Platone develops a cost effective two-layer platform where edge cloud technology supported by blockchain mechanisms provides an easy and secure access to customer level data for operation and flexibility markets. The Platone solution is developed integrating also advanced monitoring data-driven algorithms for increased observability up to the low

voltage level and the inclusion of low cost high-precision measurement devices.

Impact.

Replicability: Platone open-source software allows DSOs to experiment with innovative grid management services.

Socio-economics: Platone creates the right conditions for new business models disrupting the status quo in the field of energy economics. All these disruptive transformations will reflect also in a required change in education program at different levels.

Environment: The Platone solution facilitates a higher share of renewable energies to the grid by unlocking energy flexibilities, contributing to the reduction of greenhouse emissions and towards decarbonisation.

Market Transformation: Platone brings a significant impact in the operation of distribution grids and the marketing of flexibility, starting from the customers and the Local Energy Communities. By integrating market and operations, Platone creates the right conditions for a dual-use of data facilitating a rapid deployment of intelligent solutions and limited cost.

Policy: Platone develops proposals for changes to regulations and standards required to implement flexible markets.

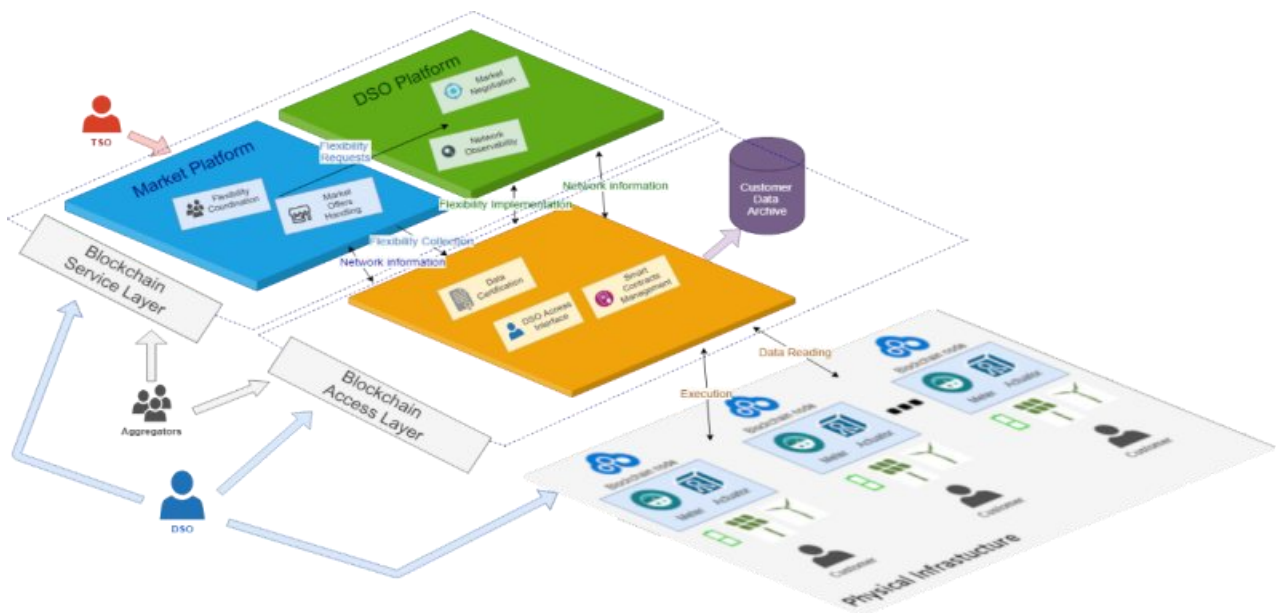



H2020 call: LC-SC3-ES-1-2019 - Flexibility and retail market options for the distribution grid

[Back to projects' list](#)

X-FLEX

Integrated energy solutions and new market mechanisms for an eXtended FLEXibility of the European grid



X-FLEX aims at designing, developing and demonstrating a set of tools to integrate the emerging decentralized ecosystem of RES and flexibility systems into the existing European energy system, in an efficient and cost-effective manner, to create more stable, secure and sustainable smart grid, with special attention to extreme weather conditions. The project addresses all the actors of the smart grid value chain, from DSO to final consumers, including microgrid operators and utilities, considering flexibility in both on the generation and on the demand side, on an individual or aggregated level.

From 2019	Project total cost	EU contribution	Website
To 2023	9.4 M€	7.3 M€	http://xflexproject.eu/

Technologies and services deployed		Project partners' countries
Technologies for consumers	Demand response	
Grid technologies	Network management and control tools	
Large-scale storage technologies	Power to Gas	
Distributed storage technologies	Batteries Thermal energy storage	
Generation technologies	PV Biogas	
Market	Electricity market Ancillary services	

Coordinator ETRA INVESTIGACION Y DESARROLLO SA (Spain)

Other partners:

- UNIVERZA V LJUBLJANI (Slovenia)
- PETROL SLOVENSKA ENERGETSKA DRUZBA DD LJUBLJANA (Slovenia)
- ELEKTRO CELJE D.D. (Slovenia)
- ALBENA AD (Bulgaria)
- ELEKTROENERGIEN SISTEMEN OPERATOR EAD (Bulgaria)
- INSTITUTE OF COMMUNICATION AND COMPUTER SYSTEMS (Greece)
- DIACHEIRISTIS ELLINIKOU DIKTYOU DIANOMIS ELEKTRIKIS ENERGEIAS AE (Greece)
- SUITE5 DATA INTELLIGENCE SOLUTIONS LIMITED (Cyprus)
- BLUEPRINT ENERGY SOLUTIONS GMBH (Austria)
- SYSTEMS SUNLIGHT INDUSTRIAL & COMMERCIAL COMPANY OF DEFENSIVE, ENERGY, ELECTRONIC AND TELECOMMUNICATIONS SYSTEMS S.A. (Greece)
- JOANNEUM RESEARCH FORSCHUNGSGESELLSCHAFT MBH (Austria)



Project Description

Context. The increasing share of Distributed Renewable Energy Sources (DRES) in the energy grid has become key for the decarbonization of the European electricity system and thus for the achievement of the EU energy and climate change policy goals. The variability and uncertainty of these distributed sources pose important risks and challenges to the stability and security of the European, national and local grids, but at the same time they open new opportunities to the energy value chain. This overall picture is completed by an emerging decentralized ecosystem where new energy systems, such as batteries, power to heat/cold, vehicle to grid and other storage solutions, are offering a large flexibility potential to the grid.

Scope. X-FLEX project proposes, a set of efficient, cost-effective, integrated solutions, that will facilitate the optimum combination of decentralised flexibility assets, both on the generation (DER) side and on the demand side (V2G, power-to-heat/cold/gas, batteries, demand response), enabling all parties, including final prosumers, to offer their flexibility in the market creating benefits to all the actors in the smart grid value chain.

X-FLEX is unique in its multi-technology, multi-actor approach which, in an increasingly RES-powered grid, will ensure security, resilience and stability for all, even under grid-stressing scenarios such as extreme climate events.

Technical description and implementation.

X-FLEX aims to develop 4 complementary products that offer services to all the energy stakeholders, from network operators (TSO, DSO, microgrid operators) to final consumers/prosumers and flexibility providers, including other intermediate players, such as retailers and aggregators.

- **SERVIFLEX tool** (Integrated flexibility management tool): It is the tool for flexibility managers to take advantage of the value of energy storage along with other demand flexibility resources towards the establishment of a holistic framework for flexibility extraction, profiling, forecasting, classification, clustering and management to serve different market and grid needs.
- **GRIDFLEX tool** (Advanced tools for automatic control and observability): It is the tool for grid and microgrid operators in order to prevent congestion (voltage and current issues) and power quality problems with the increasing share of intermittent RES, giving special attention to the potential grid problems due extreme climate events.
- **MARKETFLEX tool** (Market platform and new market mechanisms): This tool enables final consumers and prosumers (generation, DR, flexibility providers) to access the market individually, through an aggregator or through a Balancing Responsible Party to participate on different markets: wholesale market, local energy market or ancillary services market for TSO or DSO.
- **X-FLEX platform** (Flexible and scalable integrated platform): This platform integrates all the X-FLEX solutions in order to provide services for all the energy

actors and ensure more secure, stable and clean energy supply.

These solutions are tested in real conditions in 4 pilot sites in 3 EU Member states: Bulgaria, Slovenia and Greece.

Impact. Replicability: The complementarity of the project pilot sites facilitate the replicability since it is including different conditions, infrastructure and stakeholders, and therefore it facilitates the analysis for the recommendation of future implementation of the solutions after the end of the project.

Socio-economics: By means of the commercialization, deployment and implementation of the X-FLEX solutions is expected to generate 55,480 (direct and indirect) jobs related to RES after 5 years of the X-FLEX commercialization.

Environment: X-FLEX predicts to increase the RES production in the 3 pilot countries by 6,992 GWh over the next 5 years of the project. This increase in the RES production will entail a reduction of 5 MTn CO2eq of CO2 emissions in the pilot countries after the commercialization of the X-FLEX solutions.

Market Transformation: It is expected that X-FLEX will enable the increase of 28% of energy renewable into the distribution grid of the four project pilot sites by end of the project, in 2023.

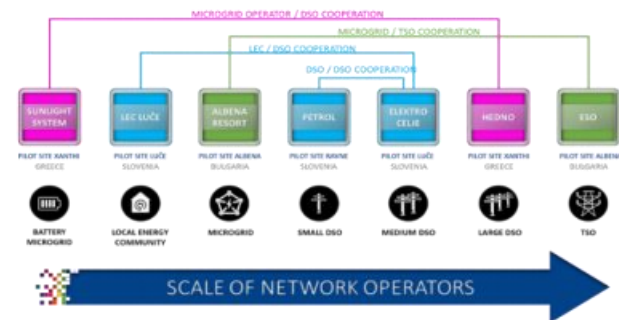



H2020 call: LC-SC3-ES-2-2019 - Solutions for increased regional cross-border cooperation in the transmission grid

[Back to projects' list](#)

FARCROSS



FARCROSS

Facilitating Regional CROSS-border Electricity Transmission through Innovation

FARCROSS promotes state of the art technologies to enhance the exploitation/ capacity/ efficiency of transmission grid assets. The hardware and software solutions aim to increase grid observability to facilitate system operations at a regional level. FARCROSS considers cross-border connections, planning to use a wide-area protection approach to ensure the safe integration of renewable energy sources into the grid, mitigate disturbances and increase power system stability.

From 2019	Project total cost	EU contribution	Website
To 2023	13.6 M€	9.9 M€	https://farcross.eu/

Technologies and services deployed

	Technologies for consumers	
	Grid technologies	Network management and control tools
	Large-scale storage technologies	
	Distributed storage technologies	
	Generation technologies	
	Market	Electricity Market Ancillary Services

Project partners' countries



Coordinator **GIOUMPITEK MELETI SCHEDIASMOS YLOPOIISI KAI POLISI ERGON PLIROFORIKIS ETAIREIA PERIORISMENIS EFTHYNIS (GREECE)**

Other partners:

- UBITECH ENERGY (Belgium)
- INDEPENDENT POWER TRANSMISSION OPERATOR SA (Greece)
- ELEKTROENERGIEN SISTEMEN OPERATOR EAD (Bulgaria)
- MAVIR MAGYAR VILLAMOSENERGIAIPARI ATVITELI RENDSZERIRANYITO ZARTKORUEN MUKODO RESZVENYTARSASAG (Hungary)
- AUSTRIAN POWER GRID AG (Austria)
- COMPANIA NATIONALA DE TRANSPORT ALENERGIEI ELECTRICE TRANSELECTRICA SA (Romania)
- HRVATSKI OPERATOR PRIJENOSNOG SUSTAVA DOO (Croatia)
- NEZAVISNI OPERATOR SISTEMA U BOSNII HERZEGOVINI (Bosnia and Herzegovina)
- OPERATORI SISTEMIT TE TRANSMETIMITOST – SHOQERI ANONIME (Albania)
- FUNDACION CIRCE CENTRO DE INVESTIGACION DE RECURSOS Y CONSUMOS ENERGETICOS (Spain)
- BUDAPESTI MUSZAKI ES GAZDASAGTUDOMANYI EGYETEM (Hungary)
- UNIVERSITATEA POLITEHNICA DIN BUCURESTI (Romania)
- SVEUCILISTE U ZAGREBU FAKULTET ELEKTROTEHNIKE I RACUNARSTVA (Croatia)
- SMART WIRE GRID EUROPE LIMITED (Ireland)
- SCHWEITZER ENGINEERING LABORATORIES ESPANA, SL (Spain)
- STUDIO ELEKTRONIKE RIJEKA DOO (Croatia)
- EUROPEAN DYNAMICS LUXEMBOURG SA (Luxembourg)
- MONITEC GMBH (Germany)
- CINTECH SOLUTIONS LTD (Cyprus)
- INNOVATIVE ENERGY AND INFORMATION TECHNOLOGIES LTD (Bulgaria)
- SOFTWARE COMPANY EOOD (Bulgaria)
- MOBILITY ENERGY INNOVATIONS KFT (Hungary)
- C & G SKUPINA, INVESTIRANJE IN SVETOVANJE DOO (Slovenia)
- WEATHERZUMBRELLA LTD (United Kingdom)
- TECH INSPIRE LTD (UNITED Kingdom)
- HOLDING SLOVENSKE ELEKTRARNE DOO (Slovenia)
- UNIPER HUNGARY ENERGETIKAI KFT (Hungary)
- BULGARSKA NEZAVISIMA ENERGIJNA BORSA EAD (Bulgaria)
- BORZEN, OPERATER TRGA Z ELEKTRIKO, D.O.O. (Slovenia)
- HUPX MAGYAR SZERVEZETT VILLAMOSENERGIA-PIAC ZARTKORUEN MUKODO RESZVENYTARSASAG (Hungary)



Project Description

Context. FARCROSS is a four-year demonstration driven project that develops a comprehensive platform of tools and metrics for establishing smart grid flexibility operation and maximizing cross-border flows. FARCROSS supports the increased interconnectivity between neighboring systems which will bring additional integration of RES in large amounts into the grid and lower energy costs for the EU consumers.

Scope. FARCROSS aims to connect major stakeholders of the energy value chain and integrate hardware and software solutions to 'unlock' resources for cross-border electricity flows and regional cooperation with the following objectives:

- Ensure that the technologies developed in FARCROSS can be used by plant and system operators to operate successfully in modern power markets;
- Provide an implementable framework that will help operators and producers to access ancillary services revenue streams;
- Increase cross-border network transfer capacity with the use of advanced power flow system;
- To increase power system security in scenarios with increasing share of renewables, enhancing fault detection capabilities at regional level.

Technical description and implementation.

FARCROSS strategically focuses on the following areas of interest (thematic areas):

- **Smart grid innovations to increase cross-border capacity:** state-of-the-art technologies enhance exploitation/ capacity/ efficiency of transmission grid assets, either on the generation or the transmission level.
- **Regional system operations:** regional level forecasting solutions that predict renewable energy production and demand side resources at a regional level, supporting wholesale, intra-day, real time markets and system daily operation will be deployed.
- **Capacity allocation for regional cross-border trading:** FARCROSS innovation tools investigate issues like (i) optimizing the usage of the available cross-border capacity for reserve procurement while transitioning from Available Transfer Capacity to Flow-Based mechanism, (ii) simultaneous interconnector reservation for energy and balancing capacity to enable reserve market coupling and (iii) state-of-the-art ICT technologies to materialize market coupling exchange platforms.



Impact. *Replicability:* FARCROSS allows the standardisation of hardware solutions (such as static series synchronous compensators and dynamic line rating systems) to exploit the full potential of power corridors. It increases regional electricity flows and improves grid stability through greater observability.

Socio-economics: FARCROSS enables the Increase of interconnectivity between neighbouring systems which is a critical enabler to successfully integrate large amounts of renewable generation and lowering energy costs for European consumers.

Environment: FARCROSS accelerates decarbonisation of the EU electricity sector, impacting climate change and the environment, by increasing the ability to manage flows of RES-generated electricity to load centres. The project has environmental benefits, such as reducing the need to develop new infrastructure corridors through greenfield areas by better utilisation of existing assets.

Market Transformation: FARCROSS creates new market opportunities, new economic opportunities, new avenues to prosperity through the enhancement and demonstration of emerging network technologies, and the open approach to sharing data. It increases competitiveness in the EU, in particular in the procurement of system services and within electricity markets, by increasing cross-border coupling and giving TSO's access to a wider range of options for flexibility.

Policy: FARCROSS applies relevant standards in each field, building on those standards to define and test new common services and data models.



H2020 call: LC-SC3-ES-2-2019 - Solutions for increased regional cross-border cooperation in the transmission grid

[Back to projects' list](#)







TRINITY

Transmission system enhancement of regional borders by means of Intelligent market technology



TRINITY enhances cooperation and coordination among the Transmission System Operators of SEE in order to support the integration of the electricity markets in the region, whilst promoting higher penetration of clean energies.

From 2019	Project total cost	EU contribution	Website
To 2023	13.1 M€	9.8 M€	http://trinityh2020.eu/

Technologies and services deployed		Project partners' countries
	Technologies for consumers	
	Grid technologies	
	Large-scale storage technologies	
	Distributed storage technologies	
	Generation technologies	
	Market	
	Demand response	
	Network management and control tools	
	Batteries	
	Wind Turbine PV	
	Electricity market Ancillary services	

Coordinator

ETRA INVESTIGACION Y DESARROLLO SA (Spain)

Other partners:

- JOINT STOCK COMPANY ELEKTROMREZA SRBIJE BELGRADE (Serbia)
- CENTAR ZA KOORDINACIJU SIGURNOSTI SCC DOO BEOGRAD-VOZDOVAC (Serbia)
- RTE INTERNATIONAL (France)
- ELEKTROENERGETSKI KOORDINACIONI CENTAR DOO (Serbia)
- SEEPEX JOINT STOCK COMPANY BELGRADE (Serbia)
- CENTRUL ROMAN AL ENERGIEI - CRE (Romania)
- INSTITUTE OF COMMUNICATION AND COMPUTER SYSTEMS (Greece)
- BERZA ELEKTRICNE ENERGIJE DOO PODGORICA (Montenegro)
- CRNOGORSKI ELEKTROPRENOSNI SISTEM AD PODGORICA (Montenegro)
- NEZAVISNI OPERATOR SISTEMA U BOSNII HERZEGOVINI (Bosnia and Herzegovina)
- KONCAR - INZENJERING ZA ENERGETIKUI TRANSPORT DD (Croatia)
- OPERATOR NA ELEKTROPRENOSNIOT SISTEM NA MAKEDONIJA AKCIONERSKO DRUSHTVO ZA PRENOS NA ELEKTRICHNA ENERGIJAI UPRAVUVANJE SO ELEKTROENERGETSKI (Bulgaria)
- ELEKTROENERGIEN SISTEMEN OPERATOR EAD (Bulgaria)
- UNIVERSITY ST KLIMENT OHRIDSKI BITOLA (Hungary)
- HUPX MAGYAR SZERVEZETT VILLAMOSENERGIA-PIAC ZARTKORUEN MUKODO RESZVENYTARSASAG (Hungary)
- BULGARSKA NEZAVISIMA ENERGIJNA BORSA EAD (Bulgaria)
- TERNA ENERGY AE (Greece)
- INSTITUT MIHAJLO PUPIN (Serbia)



Project Description

Context. The adoption of a single and unified electricity market is one of the main challenges faced by Europe today. Northern and Western Europe have already made some progress during recent years towards the achievement of this objective. However, South-Eastern Europe (SEE) is still to tackle substantial barriers in order to catch up with the more experienced EU regions. TRINITY will address this challenge in order to improve the current situation and facilitate the interconnection of South-Eastern electricity markets - among themselves and also within the current Multi Regional Coupling area (MRC).

Scope.

TRINITY aims to develop a set of solutions to enhance cooperation and coordination among the transmission system operators of SEE in order to support the integration of the electricity markets in the region, whilst promoting higher penetration of clean energies.

The main objectives of the project are:

- Enhanced cross border trading and balancing energy exchange.
- To ensure electricity market integration.
- Increased share of Renewable Energy Sources (RES) in SEE (South-Eastern Europe).
- Improved security of system operation in the context of increased RES.
- Better coordination, interaction and communication.

Technical description and implementation. This strategic goal is driven by end-users (6 TSOs, 5 NEMOS, 1 RCC and 3 RES promoters) and will be achieved through the deployment in the region of four independent, but complementary, TRINITY products:

- **T-COORDINATION PLATFORM:** TRINITY develops a modular ICT platform which would serve for RSC-TSOs and TSO-RES producers communication and coordination. The product predicts relevant situations to coordinate in different time horizons, coordinate those operations and ex-post analysis and reporting.
- **T-MARKET COUPLING FRAMEWORK:** TRINITY delivers a framework to enhance cross-border cooperation and ensure electricity market integration in SEE. Starting from the already on-going agreements to facilitate the coupling of day-ahead markets, the project proposes coordinated intra-day and capacity markets between countries in the region, considering EU and non-EU countries.
- **T-SENTINEL TOOLSET:** TRINITY delivers a regional management and operation toolset to enhance security and reliability of the existing regional structures. The T-SENTINEL toolset intends to enable remedial action optimization at regional level, as well as develop novel algorithms for improvement of Reliability Margins calculation, which will facilitate the accommodation of more RES in the region.
- **T-RES CONTROL CENTRE:** This tool will be deployed within SEE with the objective of optimizing the management and operation of renewable energy generation plants, facilitating their participation in the different electricity markets through specific

mechanisms to track and certificate the clean origin of the energy (certificates based on blockchain).

Those technologies are demonstrated in 8 different SEE countries: Serbia, Greece, Montenegro, Bosnia and Herzegovina, Croatia, North Macedonia, Bulgaria and Hungary.

Impact.

Replicability: TRINITY interconnects TSOs from 6 different countries and analyses its replication potential across SEE.
Socio-economics: TRINITY intends to affect the growth of the employment rate of SEE countries. The project is expected to create 226,912 (direct and indirect) jobs related to RES promotion in five years after TRINITY commercialization.

Environment: TRINITY may expect to increase the RES production in the SEE countries over the next 5 years of the project by 14,951 GWh, increasing in 3 % the RES production in Europe. This increase in the RES production will entail CO₂ reduction of 10,6 million Tn CO₂eq, considering an emission factor of 0,708 Tn CO₂/MWh, which represents a reduction of 3.2 % in CO₂ emissions.

Market Transformation: TRINITY fosters the own electricity capacity resources of the SEE countries by fostering the local production of renewable energies while increasing the interconnection between these countries for reducing the energy imports from non-EU countries.





H2020 call: LC-SC3-ES-8-2019 - European Islands Facility - Unlock financing for energy transitions and supporting islands to develop investment concepts

[Back to projects' list](#)







NESOI

New Energy Solutions Optimised for Islands



NESOI mainstreams green energy investments to EU islands to give them the opportunity to implement energy technologies and innovative approaches in a cost-competitive way. Starting with a broad survey gathering EU islands' needs, NESOI develops transparent technical, social, economic and environmental criteria to select, via two competitive calls, energy transition projects for customised direct support. Selected islands benefits from specific project structuring Technical Assistance provided directly by NESOI's professionals. It is supplemented by local contractors financed thanks to NESOI's cascade mechanism. Moreover, other capacity building information and toolkits are provided via a digital platform and training workshops.

From 2019	Project total cost	EU contribution	Website
To 2023	9.9 M€	9.9 M€	www.nesoi.eu

Technologies and services deployed		Project partners' countries
 Technologies for consumers  Grid technologies  Large-scale storage technologies  Distributed storage technologies  Generation technologies  Market	<p>NESOI is technology agnostic. Islands projects will be selected through two rounds:</p> <p>Round 1 will be mainly, but not only, focused on "plug-and-play" projects: projects more mature in terms of technology and/or economics and/or financing</p> <p>Round 2 will be mainly, but not only, oriented to innovative technologies in order to prove their worthiness and to serve as an example of a large spectrum of energy transition projects and relative investment concepts.</p>	

Coordinator Sinloc - Sistema Iniziative Locali SpA (Italy)

Other partners:

- R2M SOLUTION (France)
- RINA CONSULTING SPA (Italy)
- ZABALA INNOVATION CONSULTING, S.A. (Spain)
- FUNDACION CIRCE CENTRO DE INVESTIGACION DE RECURSOS Y CONSUMOS ENERGETICOS (Spain)
- ETHNIKO KENTRO EREVNAS KAI TECHNOLOGIKIS ANAPTYXIS (Greece)
- E.ON SOLUTIONS GMBH (Germany)
- WOLF THEISS RECHTSANWALTE GMBH & CO KG (Austria)
- DELOITTE ADVISORY SL (Spain)
- ELLINIKI ETAIREIA ENERGEIAKIS OIKONOMIAS (Greece)



Project Description

Context. Funds are available to finance energy efficiency and renewable energy projects. Many islands are engaged in energy transition; however, most of them haven't the expertise to concretely launch investments, access finance and kick start the projects. NESOI aims at filling this gap through a hands-on approach allowing to get the expected financial leverage towards the effective implementation of islands' energy transition plans.

Scope. NESOI is based on the following key differentiators & value drivers:

- **DRIVER 1: EU is strongly promoting EU Islands transition via policies and supporting actions.** NESOI is a deliberate policy-to-business action. NESOI aims to transform lessons learnt, policies and plans into effective investment concepts thanks to technical assistance support.
- **DRIVER 2: Green energy is worldwide considered a successful investment: investors are ready to fund!** Thanks to its consortium expertise and network of investors, NESOI brings credible investments concepts and support them turn into tangible funding allocated to EU islands.
- **DRIVER 3: Islands can be a test bench for new technologies to strengthen EU leadership in RES sector.** Energy in islands is EXPENSIVE; POLLUTING; INEFFICIENT; DEPENDENT FROM EXTERNAL SUPPLY. EU islands have to work together towards stable, cheaper, cleaner energy, to promote self-sufficiency and fight against climate change.

All these challenges are tackled by NESOI Facility's three souls: ADVISORING – TRAINING – COOPERATION (among islands and with EU industries), all competing towards mainstreaming knowledge, policies and best practices to launch concrete investments on EU islands. NESOI's main objective can therefore be summarized as follows:

To act as facilitator and stimulating platform to support access to finance for the energy transition of islands by providing them both a PHYSICAL and a DIGITAL platform offering knowledge sharing, capacity building and technical assistance to prepare cost-efficient, investible, executable and replicable energy transition projects.

Technical description and implementation. Starting with a broad survey gathering EU islands' needs, NESOI provides a platform where islands can access both indirect and direct support:

- 1) Provided through a tailor-made digital platform, the indirect support consists in training material, best case examples, toolkit for technical and economic best practices and a cooperative space for islands, investors and technology developers.
- 2) Based on transparent technical, social, economic and environmental criteria, NESOI selects projects for customised direct support from consortium experts and

from external ones for local aspects thanks to a cascade mechanism.

NESOI supports projects at different stages of development, starting from early-stage ones requiring a high-level technical & economic assistance, to more advanced ones asking for specific and detailed contributions on various fields (technical, legal, financial), putting forward a reality-check mindset, to make islands focus on solid projects with the potential to attract investors. NESOI implements capacity building and coaching activities to ensure raising awareness and capacity of public authorities' staff for developing investible projects with the aim to empower Local Communities in a success pursuit of the energy transition.

Impact. The objective of NESOI is to contribute to the energy transition on islands by mobilising at least 100M€ from public and private investors.

Replicability: NESOI partners are strongly connected to investors, island communities and the energy innovation ecosystem, and intend to develop a sustainable business model for NESOI platform. NESOI intends to remain active beyond the end of the EU-funding period in 2023, by defining a long-term sustainable business model allowing to maintain services independently.

Socioeconomics and Environment: Thanks to NESOI, EU Islands will show the way towards LOW-CARBON ISLANDS with CIRCULAR ENERGY SYSTEMS which will benefit to local island population and result in job creation, economic growth, encouraging tourism and at the same time preserving the environment.











InterConnect

Interoperable Solutions Connecting Smart Homes, Buildings and Grids



InterConnect proposes effective energy management using a resilient and practical ecosystem that is user-centric and market-driven. The project involves a range of specialised stakeholders, including advanced technology actors, manufacturers, providers and energy users. Via seven pilots, they will showcase an effective digital market for ensuring energy-efficiency at reduced costs that is beneficial to end-users.

From 2019	Project total cost	EU contribution	Website
To 2023	35.8 M€	29.9 M€	https://interconnectproject.eu/

Technologies and services deployed		Project partners' countries
	Technologies for consumers	
	Grid technologies	
	Large-scale storage technologies	
	Distributed storage technologies	
	Generation technologies	
	Market	
	<ul style="list-style-type: none"> Demand response Smart appliance Smart metering Network management and control tools Micro-grid Batteries Electric Vehicles Thermal Energy Storage Electricity market Ancillary services 	

Coordinator

INESC TEC - INSTITUTO DE ENGENHARIA DE SISTEMAS E COMPUTADORES, TECNOLOGIA E CIENCIA (Portugal)

Other partners:

- EEBUS INITIATIVE EV (Germany)
- NEDERLANDSE ORGANISATIE VOOR TOEGEPAST NATUURWETENSCHAPPELIJK ONDERZOEK TNO (Netherlands)
- VLAAMSE INSTELLING VOOR TECHNOLOGISCH ONDERZOEK N.V. (Belgium)
- EDP DISTRIBUICAO ENERGIA SA (Portugal)
- FONDACIJA VIZLORE LABS (Serbia)
- THINK E (Belgium)
- FUNDINGBOX ACCELERATOR SP ZOO (Poland)
- WINGS ICT SOLUTIONS INFORMATION & COMMUNICATION TECHNOLOGIES IKE (Greece)
- SONAE MC - SERVICOS PARTILHADOS, SA (Portugal)
- FRAUNHOFER GESELLSCHAFT ZUR FOERDERUNG DER ANGEWANDTEN FORSCHUNG E.V. (Germany)
- VOLKERWESSELS ICITY B.V. (Netherlands)
- PLANET IDEA SRL (Italy)
- GRIDNET S.A. (Greece)
- YNCREA MEDITERRANEE (France)
- ATHENS UNIVERSITY OF ECONOMICS AND BUSINESS - RESEARCH CENTER (Greece)
- ELEKTRO LJUBLJANA PODJETJE ZADISTRIBUCIJO ELEKTRICNE ENERGIJE D.D. (Slovenia)
- 3E (Belgium)
- CORDIUM CVBA (Belgium)
- STICHTING VU (Netherlands)
- IRON THERMOELEKTRIKI ANONYMI ETAIREIA (Greece)
- COSMOTE KINITES TILEPIKOINONIES AE (Greece)
- ENEDIS (France)
- ENGIE (France)
- SENSINOV (France)
- WHIRLPOOL EMEA SPA (Italy)
- RICERCA SUL SISTEMA ENERGETICO - RSE SPA (Italy)
- POLITECNICO DI MILANO (Italy)
- CYBERGRID GMBH & CO KG (Austria)
- REALDOLMEN NV (Belgium)
- EUROPEAN DISTRIBUTION SYSTEM OPERATORS FOR SMART GRIDS (Belgium)
- OPENMOTICS (Belgium)
- KEO GMBH (Germany)
- ABB OF ASEA BROWN BOVERI (Belgium)
- UNIVERSITAET KASSEL (Germany)
- DEUTSCHES FORSCHUNGSZENTRUM FUR KUNSTLICHE INTELLIGENZ GMBH (Germany)
- Fachhochschule Dortmund (Germany)



- THERMOVAULT (Belgium)
- TRIALOG (France)
- DOMOTICA SGTA GESTAO TECNICA E AUTOMACAO LDA (Portugal)
- SCHNEIDER ELECTRIC PORTUGAL LDA (Portugal)
- VRIJE UNIVERSITEIT BRUSSEL (Belgium)
- INTERUNIVERSITAIR MICRO-ELECTRONICA CENTRUM (Belgium)
- DUCCOOP (Belgium)

- BOSCH THERMOTECHNIK GMBH (Germany)
- BSH HAUSGERATE GMBH (Germany)
- MIELE & CIE KG (Germany)
- WIRELANE GMBH (Germany)
- VAILLANT GMBH (Germany)
- DAIKIN EUROPE N.V. (Belgium)
- KNX ASSOCIATION CVBA (Belgium)

Project Description

Context. Over the last few years several projects and technology providers have come up with solutions that allow every energy user to have awareness and control over his appliances, but there has always been a major issue with interoperability. End-users should be able to choose and change their technology providers, without having to replace their installation, every time they feel this need and still be able to adopt sustainable behaviour and benefit from technological advances.

Scope. In the energy sector, a steep move towards digital is occurring and becoming tremendously user-centric and market-driven. The main goal of InterConnect? Bringing efficient energy management within reach of the end-users by interoperable Solutions Connecting Smart Homes, Buildings and Grids.



Technical description and implementation. The solutions developed within the scope of InterConnect will allow a digitalisation of homes, buildings and electric grids based on an Internet of Things (IoT) architecture. By including digital technologies (artificial intelligence, blockchain, cloud and big data) based on open standards, such as SAREF, it will guarantee the interoperability between equipment, systems and privacy/cybersecurity of user data. Energy users in buildings, either residential or non-residential, manufacturers, distribution grid operators and the energy retailers will have the opportunity to take advantage of these solutions. The InterConnect project focuses on eight major domains: standardisation, ontology, digital platforms, IoT, cloud, electric grid, big data and cybersecurity.

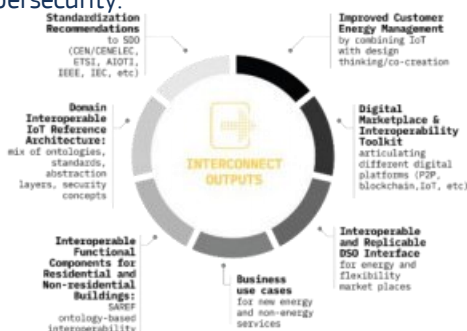

Impact. Replicability: The replication of innovative solutions in different domains, regions and setups allowing to move from single solutions to an integrated management at a higher scale, while focusing on interoperable and competitive solutions, is the main focus of the project.

Socio-economics: The exploitation plans of partners will accelerate the uptake of InterConnect results. It will contain the assessment of the socio-economic impacts and the factors that would influence their exploitation (ex.: standardisation, regulatory aspects). Also, the project is focused on generating economic and social benefits by stimulating behavioural change in energy consumption. Moreover, an economic, social and environmental analysis of the participation of energy communities in the DSF will be performed.

Environment: The overarching objective of the project pilots is to demonstrate a EU digital market environment with the integration of demand side flexibility, reducing operational and investment costs that will benefit energy end-users and the grid and contribute to the EU energy efficiency goals. The project will generate environmental benefits, by maximizing the use of RES and helping reducing energy poverty.

Market Transformation: In the energy sector, a steep move towards a user-centric and market-driven digitalization. InterConnect aims at providing toolboxes for interoperability towards the creation of marketplaces, for energy and non-energy services, to be used by third parties, integrating them with the project digital platforms, devices and existing services. InterConnect vision is to link multisided platforms in multidomain to address market needs, supporting the EU Digital Single Market, adopted in May 2015, that leads Europe a step further in IoT developments.

Policy: Recommendations and measures to policy makers will be identified to foster decentralised energy market and RES use. The methods that will be used within the scope of the InterConnect project will provide contributions to standards, regulation, policy recommendations and practical tools. Specific spaces will be created in the project community for regulators and policy makers, to share the best practices and the societal impact that results from the project.

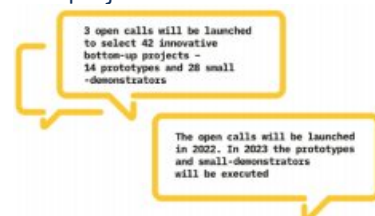



BD4OPEM

Big Data for OPen innovation Energy Marketplace



BD4OPEM develops an open innovation marketplace where, through an analytic toolbox that integrates solutions based on artificial intelligence, products and services to improve the monitoring, operation, maintenance and planning of electrical distribution grids are made available to stakeholders.

From 2020	Project total cost	EU contribution	Website
To 2023	9.8 M€	8 M€	www.bd4opem.eu

Technologies and services deployed	Project partners' countries
------------------------------------	-----------------------------

Technologies for consumers	Demand response Smart appliance Smart metering
Grid technologies	Network management and control tools Micro-Grid
Large-scale storage technologies	
Distributed storage technologies	Batteries Electric vehicles
Generation technologies	Wind turbine PV Micro-generation
Market	Electricity market Ancillary services



Coordinator	UNIVERSITAT POLITECNICA DE CATALUNYA (Spain)
--------------------	---

Other partners:

- WE PLUS SPA (Italy)
- Odit-e (France)
- ATOS SPAIN SA (Spain)
- INSTITUT JOZEF STEFAN (Slovenia)
- INTRACOM SA TELECOM SOLUTIONS (Greece)
- NUVVE DENMARK APS (France)
- OSMANGAZI ELEKTRIK DAGITIM ANONIM SIRKETI (Turkey)
- VRIJE UNIVERSITEIT BRUSSEL (Belgium)
- ESTABANELL Y PAHISA ENERGIA SA (Spain)
- ELEKTRO CELJE D.D. (Slovenia)
- SUSTAINABLE INNOVATION I SVERIGE AB (Sweden)



Project Description

Context. Energy power systems face important challenges to cope with the requirements and needs of an ever-increasing number of distributed generation and consumption devices in an interconnected world. Energy systems have seen a natural evolution, moving from the analogue world to the current digital interconnected real-time IoT world. Now, huge amounts of energy systems data are available, most of which are unused or underused. The appropriate monitoring, acquisition and processing of this data can boost innovative tools and services.

Scope. The BD4OPEM strategy is to share data and to provide data analytics services in an Open Innovation Marketplace. It should be like an “energy supermarket” where users find the solutions they need using the services provided by different specialized companies. In this “market place”, several solutions serve the DSO’s and other stakeholders for a better management of their networks. This project extracts more value from the available data providing new big data solutions for the operation, planning and maintenance of highly complex networks, including services like grid topology identification, observability, predictive maintenance, fraud detection, smart houses, buildings and industries energy management, blockchain transactions and flexibility aggregation for demand-response.

Technical description and implementation. The Open Innovation Marketplace is based on well-known and proven open big data reference architectures, and relying on an underlying analytics toolbox. The analytic toolbox ensures secure data flows from data providers to solution providers, always compliant with GDPR requirements, so that asset management is enhanced, consumer participation in energy balancing is promoted and new data-driven business models are created. Solutions are based on artificial intelligence techniques including supervised learning, deep learning, data mining, among others.

The project aims to demonstrate these features at 5 pilot sites (Spain, Turkey, Slovenia, Belgium and Denmark) with distributed energy generation, such as photovoltaic, storage infrastructure, EV and charging infrastructure, hydro, wind and geothermal generation.

Impact. *Replicability:* Data are collected from legacy systems and stored in a public data lake. This structure enables new and existing players to link their platforms to the lake. The platform ensures replicability and scalability, fully compatible and open to everyone.

Socio-economics: BD4OPEM creates growth possibilities for the project members, for the energy sector in general, the European IT market and the European Sustainable Innovation Ecosystem. It results in the creation of highly qualified jobs in the ICT and energy sectors. Also, it reduces the technology gap between countries. The project intends to facilitate a technology convergence and promote innovative big data solutions for energy in countries where there is less data and technology available.

Environment: BD4OPEM encourages a more efficient use of energy resources and the penetration of renewable

energy, leading to a reduction in greenhouse gas emissions and promoting a more effective and smart usage of energy through flexibility and storage.

Market Transformation: BD4OPEM is a clear example of interaction between different stakeholders. Exploitation and dissemination tasks aim to facilitate the extension of this model to the European Sustainable Innovation Ecosystem.

Policy: The topics addressed within BD4OPEM are consistent with European and international standards, policies and initiatives, aiming to develop the next generation technologies. Furthermore, the project is dedicated to advancement and enrichment of these efforts. Due to BD4OPEM scalability, interconnectivity and replicability in specific countries and markets, it has the potentiality to become a reference tool in the Energy sector so it can also become an efficient way to facilitate the introduction of regulations and standards advancing towards the Energy Union.

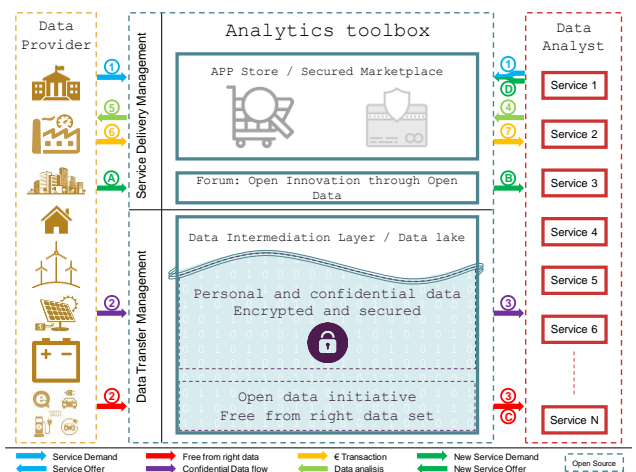



PLATOON







Digital PLATform and analytic TOOlS for eNergy



PLATOON
Digital platform and analytic tools for energy

PLATOON develops a COSMAG Compliant reference Platform with flexible capabilities in (1) Interoperability, to deal with a wide spectrum and heterogenous data sources, formats, interfaces and enable data exchange between platforms, (2) Data Governance & Security to answer multiple data owners and providers, digital sovereignty challenges, (3) Data Analytics Toolbox and Edge Computing for data processing and analysis in batch and real time.

From 2020	Project total cost	EU contribution	Website
To 2022	11.5 M€	10 M€	http://platoon-project.eu/

Technologies and services deployed		Project partners' countries
	Technologies for consumers	
	Grid technologies	
	Large-scale storage technologies	
	Distributed storage technologies	
	Generation technologies	
	Market	

Coordinator **ENGIE (France)**

Other partners:

- FUNDACION TECNALIA RESEARCH & INNOVATION (Spain)
- RHEINISCHE FRIEDRICH-WILHELMS-UNIVERSITAT BONN (Germany)
- FRAUNHOFER GESELLSCHAFT ZUR FOERDERUNG DER ANGEWANDTEN FORSCHUNG E.V. (Germany)
- ENGINEERING - INGEGNERIA INFORMATICA SPA (Italy)
- CLUSTER DE ENERGIA (Spain)
- VRIJE UNIVERSITEIT BRUSSEL (Belgium)
- INSTITUT MIHAJLO PUPIN (Serbia)
- GIROA SOCIEDAD ANONIMA (Spain)
- TECHNISCHE INFORMATIONSBIBLIOTHEK (TIB) (Germany)
- POLITECNICO DI MILANO (Italy)
- ROMA CAPITALE (Italy)
- SISTEPLANT SL (Spain)
- SAMPOL INGENIERIA Y OBRAS S.A. (Spain)
- POSTE ITALIANE - SOCIETA PER AZIONI (Italy)
- MANDAT INTERNATIONAL (Switzerland)
- FUNDINGBOX ACCELERATOR SP ZOO (Poland)
- INDRA SOLUCIONES TECNOLOGIAS DE LA INFORMACION, SL (Spain)
- COMSENSUS, KOMUNIKACIJE IN SENZORIKA, DOO (Slovenia)
- UDG ALLIANCE (Switzerland)



Project Description

Context. Nowadays electricity covers almost 20% of global energy consumption and it is expected to rise exponentially during the next decades both in absolute and relative terms. This growth is mainly driven by three factors: 1) world population increase, 2) need for greener energy sources to fight global warming 3) the disruption of new technologies such as electric transportation and digital technologies.

The electricity sector is shifting towards decentralization and decarbonization. The rise of renewable energy sources demands algorithms to predict and help avoid the disturbances into the grid. However, a new system is needed, in order to efficiently manage Energy flexibility. On the other hand, up to now, power systems have been designed to meet infrequent peaks in demand and to comply with excessive safety margins which, in many cases, has resulted in costly and underutilized infrastructure. In this sense, smarter consumption of electricity and condition monitoring of the assets, could deliver significant savings by improving the utilization of the existing infrastructure.

Scope. PLATOON (digital PLAtform and analytical TOOLS for eNergy) is presented as a breakthrough COSMAG compliant reference platform with flexible capabilities covering a wide number of challenges and solutions:

- Interoperability: to deal with a wide spectrum and heterogenous data sources, formats, interfaces.
- Data governance and security: to answer multiple data owners and providers,
- Digital Tools Easy to use by energy domain experts without deep mathematical knowledge: The toolbox will provide “out of the box” mathematical techniques like statistical characterization, classification, prediction, optimization, to the energy sector needs: predictive maintenance and life extension of energy assets, distribution grids optimum management, peak power avoidance and demand side response, efficient end use of energy.

Technical description and implementation. The project defines and promotes a COSMAG-compliant reference architecture, designs and develops an open, vendor-independent data governance scheme based on IDS principles which guarantees data sovereignty and privacy for all the stakeholders. Partners develop a specific interoperability layer that enables heterogenous, bulky and high speed-data transfer from the pilots to the PLATOON platform. It develops, deploys, integrates and validates a data analytics toolbox easy to be used by energy experts and customized to solve the specific needs of the energy infrastructures operators and data owners. Finally, it designs and implements local real time processing capabilities in the edge to provide local smartness and alleviates the data transfer to the PLATOON components deployed in the cloud.

Impact. *Replicability:* PLATOON develops an interoperability layer using open APIs and open data models based on existing standards that facilitate data sharing, exchange and integration amongst different

platforms. This enables future replicability and use and reduces market acceptance risks.

Socio-economics: PLATOON provides environments which are both secure and aware of the sovereignty of digital data, while stressing the ability to exchange them with confidence and to develop economic services which will have an impact on social processes in the fields of energy use and renewable energies.

Environment: PLATOON contributes to increasing the use of renewable energy and increased energy efficiency based on optimised energy asset management, offering access to cheaper and sustainable energy for energy consumers and maximising social welfare.

Market Transformation: PLATOON creates new data-driven business models, opportunities and innovative energy services & Increasing consumer participation.

Policy: PLATOON promotes emergence of sustainable ecosystems around digital platforms and strengthened links with other programmes and initiatives, supported by regional, national and European policies and funds.





SYNERGY

Big Energy Data Value Creation within Synergetic energy-as-a-service applications through trusted multi-party data sharing over an AI big data analytics marketplace.



SYNERGY introduces a novel framework and reference big data architecture that leverages data, primary or secondarily related to the electricity domain.

From 2020	Project total cost	EU contribution	Website
To 2023	14.1 M€	9.9 M€	https://www.synergymh2020.eu/

Technologies and services deployed	Project partners' countries
Technologies for consumers Grid technologies Large-scale storage technologies Distributed storage technologies Generation technologies Market	<p>Demand response Smart appliance Smart metering Network management and control tools</p>

Coordinator

ETRA INVESTIGACION Y DESARROLLO SA (SPAIN)

Other partners:

- DIACHEIRISTIS ELLINIKOU DIKYTOU DIANOMIS ELEKTRIKIS ENERGEIAS AE (Greece)
- INSTITUTE OF COMMUNICATION AND COMPUTER SYSTEMS (Greece)
- FORUM VIRIUM HELSINKI OY (Finland)
- Teknologian tutkimuskeskus VTT Oy (Finland)
- MONTAJES ELECTRICOS CUERVA S.L. (Spain)
- COBRA INSTALACIONES Y SERVICIOS S.A (Spain)
- SUITES DATA INTELLIGENCE SOLUTIONS LIMITED (Cyprus)
- SISTEMAS URBANOS DE ENERGIAS RENOVABLES SL (Spain)
- FUNDACION CIRCE CENTRO DE INVESTIGACION DE RECURSOS Y CONSUMOS ENERGETICOS (Spain)
- GIOUMPITEK MELETI SCHEDIASMOS YLOPOIISI KAI POLISI ERGON PLIROFORIKIS ETAIREIA PERIORISMENIS EFTHYNIS (Greece)
- CAVERION SUOMI OY (Finland)
- INDEPENDENT POWER TRANSMISSION OPERATOR SA (Greece)
- ETAIREIA PAROHIS AERIOU ATTIKIS - ELLENIKI ANONYMI ENERGEIAS FYSIKO AERIO - ELLENIKI ETAIREIA ENERGEIAS (Greece)
- PONIKVE EKO OTOK KRK DOO ZA KOMUNALNE DJELATNOSTI (Croatia)
- MAGGIOLI SPA (Italy)
- KNOWLEDGEBIZ CONSULTING-SOCIEDADE DE CONSULTORIA EM GESTAO LDA (Portugal)
- KONCAR - INZENJERING ZA ENERGETIKUI TRANSPORT DD (Croatia)
- UNIVERSITY OF CYPRUS (Cyprus)
- ELIN VERD ANONYMI ETAIRIA AEIFORONPROIONTON KAI YPIRESION (Greece)
- ENERGIE GUSSING GMBH (Austria)
- EUROPAISCHES ZENTRUM FUR ERNEUERBARE ENERGIE GUSSING GMBH (Austria)
- GECO GLOBAL IVS (Denmark)
- ENERGY SERVICES HANDELS- UND DIENSTLEISTUNGS GMBH (Austria)



Project Description

Context. The European electricity sector is undergoing a huge shift away from traditional monitoring and control approaches that have been applied exclusively over the transmission and distribution networks, since the smart electricity grid era is pushing sensing, control and data collection at the edge of electricity networks, which needs to be further re-defined due to the wide penetration of Distributed Energy Resources (DERs), such as renewable energy sources (RES), smart home devices and appliances (IoT-enabled), distributed storage, smart meters and electric vehicles (EVs). Consequently, the need for “end-to-end” coordination between the electricity sector stakeholders, not only in business terms but also in exchanging information between them is becoming a necessity to enable the realization of the high-level objective of increasing electricity networks’ stability and resilience, while satisfying individual operational optimization objectives and business case targets of all stakeholders in the electricity sector.

Scope. SYNERGY introduces a highly effective, innovative and scalable reference architecture and implementation for a Big Energy Data Platform and Analytics Marketplace, accompanied by big data-enabled domain specific applications to help the electricity value chain stakeholders to enhance their data reach, improve their internal intelligence and optimize operations and benefits, while introducing themselves into novel business ecosystems based on data (intelligence) sharing/ trading, for further intelligence and benefits enhancement, provision of new and innovative energy-related services and creation of new revenue streams out of the data and the intelligence they produce. The real value of the SYNERGY framework stems from the benefits it will generate for all involved electricity sector actors, through the provision of bundle of innovative (analytics-based) applications and services, addressing their emerging business and optimization needs and facilitating the realization of a data sharing-based energy economy with profound benefits, as further analysed below.

Technical description and implementation. SYNERGY bears 5 Core Data Services Bundles:

- Data Collection Services Bundle (Data Ingestion, Curation, Mapping, Linking and Update);
- Data Security Services Bundle, that is responsible for safeguarding and securing any data asset (and app);
- Data Sharing Services Bundle handling the adopted sharing/trading mechanisms, the effective remuneration approach and the multi-party data contracting lifecycle;
- Data Matchmaking Services Bundle (a demand-driven mentality as opposed to the typical supply-driven operation of the data marketplaces);
- Data Analytics Services Bundle that essentially allows for exploratory data analysis, designing and executing analytics workflows, and running pre-trained analytics to generate new insights and knowledge.

Impact. *Replicability:* SYNERGY provides high replicability across different contexts, energy systems and market conditions as well as tested and validated in real-life

settings in 5 large-scale demonstrators in Greece, Spain, Austria, Finland and Croatia.

Socio-economics: SYNERGY Improves buildings’ energy performance and energy cost reduction with significant energy costs savings for energy consumers and facility managers and easy and transparent participation of prosumers in energy markets.

Environment: SYNERGY Increases penetration and integration of Renewable Energy Sources, optimizes operational and asset management of RES plants, supports the booming of VC investments in green tech and contributes to decarbonisation.

Market Transformation: SYNERGY enhances operational stability, network availability, power quality and resilience of energy networks, allows advanced observability and monitoring of energy performance over entire districts and cities and facilitates urban planning processes towards realizing smart city commitments in the short- and mid-term. It creates new business opportunities for electricity retailers and new revenue streams for energy prosumers and local aggregators.

Policy: SYNERGY increases compliance of electricity utilities to Energy Efficiency Obligations imposed by the EU and national regulatory authorities and EU support to entrepreneurship.





BD4NRG

Big Data for Next Generation Energy



A cross-stakeholder energy-centered value chain open and interoperable framework for big data-driven AI-based analytics energy services

From 2021	Project total cost	EU contribution	Website
To 2023	11.88 M€	9.99 M€	https://www.bd4nrg.eu

Technologies and services deployed		Project partners' countries
	Technologies for consumers	
	Grid technologies	
	Large-scale storage technologies	
	Distributed storage technologies	
	Generation technologies	
	Market	

Coordinator ENGINEERING INGEGNERIA INFORMATICA (ITALY)

Other partners:

- NATIONAL TECHNICAL UNIVERSITY OF ATHENS (Greece)
- RHEINISCH-WESTFAELISCHE TECHNISCHE HOCHSCHULE AACHEN (Germany)
- EUROPEAN DYNAMICS SA (Luxembourg)
- INTERNATIONAL DATA SPACES EV (Germany)
- EUROPEAN NETWORK OF TRANSMISSION SYSTEM OPERATORS FOR ELECTRICITY AISBL (Belgium)
- PANEPISTIMIO DYTIKIS ATTIKIS (Greece)
- ATOS SPAIN SA (Spain)
- FUNDACION CARTIF (Spain)
- UNIVERZA V LJUBLJANI (Slovenia)
- ENEL X SRL (Italy)
- REN - REDE ELECTRICA NACIONAL SA (Portugal)
- CENTRO DE INVESTIGACAO EM ENERGIA REN - STATE GRID SA (Portugal)
- UNINOVA-INSTITUTO DE DESENVOLVIMENTO DE NOVAS TECNOLOGIAS-ASSOCIACAO (Portugal)
- ENERCOUTIM - ASSOCIACAO EMPRESARIALDE ENERGIA SOLAR DE ALCOUTIM (Portugal)
- FIWARE FOUNDATION EV (Germany)
- CENTRICA BUSINESS SOLUTION (Belgium)
- NEDERLANDSE ORGANISATIE VOOR TOEGEPAST NATUURWETENSCHAPPELIJK ONDERZOEK TNO (The Netherlands)
- ASM TERNI SPA (Italy)
- VIDES INVESTICIJU FONDS SIA (Latvia)
- COMSENSUS, KOMUNIKACIJE IN SENZORIKA (Slovenia)
- HOLISTIC IKE (Greece)
- INTERUNIVERSITAIR MICRO-ELECTRONICA CENTRUM (Belgium)
- TERRASIGNA SRL (Romania)
- UBIMET GMBH (Austria)
- ELEKTRO LJUBLJANA PODJETJE ZADISTRIBUCIJO ELEKTRICNE ENERGIJE D.D. (Slovenia)
- BORZEN, OPERATER TRGA Z ELEKTRIKO,D.O.O. (Slovenia)
- AJUNTAMIENTO DE SANT CUGAT DEL VALLES (Spain)
- ELES DOO SISTEMSKI OPERATER PRENOSNEGA ELEKTROENERGETSKEGA OMREZJA (Slovenia)
- E-LEX - STUDIO LEGALE (Italy)
- OSMANGAZI ELEKTRIK DAGITIM ANONIM SIRKETI (Turkey)
- VEOLIA SERVICIOS LECAM SOCIEDAD ANONIMA UNIPERSONAL (Spain)
- STICHTING EGI (The Netherlands)
- CINTECH SOLUTIONS LTD (Cyprus)
- EMOTION SRL (Italy)



Project Description

Context. The rising decentralization of the energy system is unveiling an enormous opportunity for energy stakeholders to leverage on big data & AI technologies to improve decision making. Moreover the Energy system progressive decarbonisation and decentralization and the EC Green New Deal policy towards an integrated energy system are pushing for cross-stakeholder multiple value chain use cases, data-driven applications, platforms, architectures and services, facilitated by Open Energy – centered Cross-sector Digital Platforms. There are however some barriers hampering the exploitation of this potential, such as the lack of standardized big data architectures for smart grids and regulatory frameworks not facilitating data sharing.

Scope. The overall BD4NRG service analytics reference framework and the underlying technology enablers will be deployed and validated in 12 large-scale demo-sites across 9 countries. Rationale of pilot applications is to address in a combined way two of the major challenges actually hindering big data analytics value capturing in smart energy grids, i.e. i) nurturing the shifting towards Predictive/prescriptive analytics and ii) enabling multiple data source (cross –functional and/or cross-contexts and/or cross-domain) analytics for multiple applications

Technical description and implementation.

BD4NRG will i) deliver a reference architecture for Smart Energy, which aligns BDVA SRIA, IDSA and FIWARE architectures, SAREF standard to enable B2B multi-party data exchange, while providing full interoperability of leading-edge big data technologies with smart grid standards and operational frameworks ii) evolve and upscale a number of technology enablers, such as scalable sovereignty-preserving hybrid DLT/off-chain data governance, big data elastic pipeline orchestration, IoT/edge AI-based federated learning and multi-resource sharing tokenized marketplace, loosely integrate and deploy them within the BD4NRG framework iii) deliver a TRL8 open modular big data analytic toolbox as front-end for one-stop-shop analytics services development by orchestrating legacy and/or third party assets (data, computing resources, models, algorithms) iv) validate such framework through the delivery of predictive and prescriptive edge AI-based big data analytics on 12 large scale pilots, deployed by different energy stakeholders (TSOs and DSOs power network operators, aggregators, storage/renewable assets operators, local energy communities, ESCOs, power market operators, municipalities, financial institutions and ENTSO-E), fully covering the energy value chain v) setup a vibrant data-driven ecosystem, which will federate new energy data providers, attract SMEs for novel energy services provisioning through cascading funding and validate a hybrid energy/industry value chain supporting B2B joint digital platforms

Impact. Replicability: the large geographical coverage of the pilot sites aims to support the large-scale EU-wide replicability and market take-up of services and solutions in different socio-economical contexts to maximize the impact of BD4NRG services across Europe.

Socio-economics: the data-driven BD4NRG analytics toolbox and services will enable the significant changes which are expected in the energy industry thanks to the adoption of new disruptive processes aimed at integrating different energy resources at local level. ICT technologies allow the usage of new market logic able to propose innovative customer-centric more decentralized business models exploiting the potential of digitalization. Tokenized DLT/Blokchains/smart contract marketplaces on the other hand will facilitate local-community level trade and exchange of heterogeneous assets, including energy surplus, social services, share of computing resources, hence contributing to the improved social welfare of local communities.

Environment: The solutions proposed in BD4NRG will clearly bring a significant positive benefit on the environmental footprint of the grid operation and on the decarbonisation of the overall energy systems. As matter of fact, using flexible demand optimized mobilization, via BD4NRG optimized small scale DER flexibility assets management, and leveraging on enhanced integration of asset management and grid operation, BD4NRG will contribute to reduce peak loads, improve the efficiency of the utilization of the electricity network, postpone any unnecessary investment in grid capacity reinforcement and minimize the necessity to turn on the emergency peaking plants (which are much less efficient than the baseload power plants that normally power the grid). In addition to this, BD4NRG will increase the local consumption of locally generated electricity, which heavily contributes to reduce network losses reduction, due to the reduced need of long-distance electricity transportation. Hence the environmental footprint of the grid operation during peak load times will be greatly reduced.

Market Transformation: Thanks to the deployment of near real time data driven analytics services , BD4NRG will slightly contribute to open up and redesign the energy value chain and the way through which energy and beyond-energy stakeholders will interact one each other, contributing to more liquid and competitive energy marketplaces, and to lowering transaction costs and energy price for the consumers The latter ones, on the other way around, will be brought center stage as new relevant actors of the energy value chain, whose profile and preferences will be taken into due consideration to achieve a fair, effective, consumer-entered energy system *Policy:* The vision pursued and the big data-driven analytics technologies deployed by BD4NRG will slightly contribute to further nurture some of the most relevant EC policies, ranging from EC Data Strategy, to the Green New Deal, and the Energy Digitization Plan, while at the same time offering increased accessibility of energy-centered local community social services hence contributing to energy poverty mitigation.



H2020 call: LC-SC3-EC-3-2020 – Consumer Engagement and Demand Response

[Back to projects' list](#)

ACCEPT

Active Communities & Energy Prosumers for the energy Transition



The EU-funded ACCEPT aims to design a digital toolbox that will enable the delivery of compound Demand Response services to prosumers within Energy Communities and at the same time enable their participation in energy markets through the formulation of community-based Virtual Power Plants.

From 2021 To 2024	Project total cost	EU contribution	Website
	7.57 M€	5.86 M€	www.accept-project.eu

Technologies and services deployed		Project partners' countries
	Technologies for consumers	
	Grid technologies	
	Large-scale storage technologies	
	Distributed storage technologies	
	Generation technologies	
	Market	
	Demand Response Smart Metering	
	Micro-grid	
	Batteries Electric Vehicles Power to heat	
	PV	
	Ancillary Services Electricity market	

Coordinator

**HYPERTECH (CHAIPERTEK) ANONYMOS VIOMICHANIKI EMPORIKI
ETAIREIA PLIROFORIKIS KAI NEON TECHNOLOGION (GR)**

Other partners:

- CIRCE (ES)
- GECO GLOBAL (DK)
- QUE TECHNOLOGIES (GR)
- ETHNIKO KENTRO EREVNAS KAI TECHNOLOGIKIS ANAPTYXIS - CETH (GR)
- WITSIDE INTERNATIONAL MARKETS LIMITED (CY)
- UNIVERSITY COLLEGE CORK (IE)
- RINA CONSULTING SPA (IT)
- MYTILINEOS SA (GR)
- BEDRIJFSBUREAU ENERGIE SAMEN BV (NL)
- COOPERATIEF ENERGIE DIENSTENBEDRIJF RIVIERENLAND BA (NL)
- MY ENERGIA ONER SL (ES)
- LA SOLAR ENERGIA SOCIEDAD COOPERATIVA (ES)
- AZIENDA ELETTRICA DI MASSAGNO (AEM) SA (CH)
- VIESGO DISTRIBUCION ELECTRICA SL (ES)
- EUROPAISCHES ZENTRUM FUR ERNEUERBARE ENERGIE GUSSING GMBH (AT)



Project Description

Context: The ACCEPT project will deliver a digital toolbox that allows Energy Communities to offer innovative digital services and access revenue streams that can financially support their operations and secure their sustainability and effectiveness. The ACCEPT framework will be demonstrated and validated in four pilot sites in Greece, the Netherlands, Spain and Switzerland involving more than 3000 people and 750 residences directly and indirectly.

Scope: The key objectives of ACCEPT are:

- To deliver an integrated tool-chain to bootstrap the transition of energy communities to full players of the energy & flexibility markets.
- To deliver a secure and interoperable digital solution compatible with the majority of residential building systems used across the EU.
- To analyse the incentives and drivers of citizens and energy communities and create a citizen engagement methodology that stimulates citizen participation in the energy system and community flourishing.
- To design compound (energy & non-energy) service offerings and business models that enable the participation of the residential sector in demand response markets/services.

Technical description and implementation: ACCEPT involves three activity lines developed around energy communities:

- The development of an integrated Digital Toolbox that enables:
 - Compound Demand Response service offerings (energy & non-energy) to community members.
 - Energy/ flexibility exchange through community p2p trading.
 - Formulation of community-based VPPs to offer aggregated residential demand flexibility potential to electricity/ flexibility markets.
- The stipulation of a Citizen Engagement Methodology to evaluate prosumer acceptance and benefits to an energy community.
- The definition of new market models for flexibility valorisation and new business models that unleash value stacking perspective for prosumers as members of energy communities.

Impact: The ACCEPT solution will be validated in real-life conditions including citizens and energy communities in four Member States (GR, ES, NL, CH).

Replicability: The tools of ACCEPT will be demonstrated in diverse contexts regarding energy community structure/ composition/ objectives, regulation frameworks, DR monetization opportunities, etc. to validate their replicability across Member States.

Socio-economics: ACCEPT will deliver socio-technical solutions that enable citizens to understand the energy transition impact in their daily life and adapt their energy behaviour accordingly as well as to support energy

communities as an organization instrument for the achievement of the energy transition objectives.

Environment: ACCEPT intends to increase vRES-based self-sufficiency at energy community level above 30% reducing CO2 emissions accordingly.

Market Transformation: ACCEPT aims to investigate acceptance of forward-looking services (e.g., Heating-as-a Service) during pilot demonstrations and extrapolate the findings to assess commercialisation routes.

Policy: Investigation of feasible ways to incentivise citizens to embrace the energy transition lie at the core of ACCEPT. These will also lead to policy recommendations to drive legislation toward acceptable and efficient solutions.

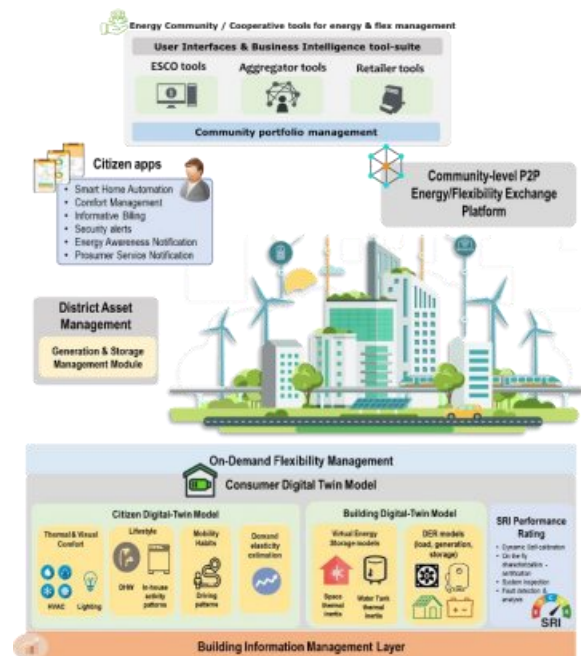









BRIGHT

Boosting DR through increased community-level consumer engagement by combining Data-driven and blockChain technology Tools with social science approaches and multi-value service design



A participatory process to bring individual consumers center stage to deliver community-centered DR, combining social-science-driven user experience design with innovative technologies

From 2020	Project total cost	EU contribution	Website
To 2023	5.88 M€	4.66 M€	https://www.brightproject.eu/

Technologies and services deployed		Project partners' countries
	Technologies for consumers	
	Grid technologies	
	Large-scale storage technologies	
	Distributed storage technologies	
	Generation technologies	
	Market	
	Demand Response Smart Appliance Microgrid Network management Tools	
	Batteries EVs Power to heat PV	
	Electricity market Ancillary Services	

Coordinator ENGINEERING INGEGNERIA INFORMATICA (ITALY)

Other partners:

- UNIVERSITATEA TEHNICA CLUJ-NAPOCA (Romania)
- INTERUNIVERSITAIR MICROELECTRONICA CENTRUM (Belgium)
- COMSENSUS, KOMUNIKACIJE IN SENZORIKA (Slovenia)
- SONCE ENERGIJA (Slovenia)
- ISKRAEMECO, MERJENJE IN UPRAVLJANJEENERGIJE (Slovenia)
- EMOTION SRL (Italy)
- NEDERLANDSE ORGANISATIE VOOR TOEGEPAST NATUURWETENSCHAPPELIJK ONDERZOEK (Netherlands)
- CENTRICA BUSINESS SOLUTIONS BELGIUM (Belgium)
- ASM TERNI SPA (Italy)
- DUCCOOP (Belgium)
- CYBERETHICS LAB SRLS (Italy)
- DOMX IDIOTIKI KEFALAIOUCHIKI ETAIREIA (Greece)
- ASOCIATIA PRO CONSUMATORI (Romania)
- WATT AND VOLT ANONIMI ETAIRIA EKMETALLEYSIS ENALLAKTIKON MORFON ENERGEIAS (Greece)
- SUNCONTRACT OU (Estonia)



Project Description

Context. The increasing electrification of heat and transport coupled with larger RESs deployment of decentralized RESs is disclosing new additional opportunities for demand response. However, DR potential has been exploited so far to a very limited extent at end consumer residential level, due to technologies immaturity, regulatory fuzziness, distorted business framework preventing end consumers to capture an appropriate value. To cope with the above challenges, BRIGHT will leverage on a participatory co-creation process to bring individual consumers center stage to deliver a multi-layered community-centred cross-domain adaptable multi-timescale DR supporting framework. This framework will combine social-science-driven user experience design -for user behavior motivations and monetary/non-monetary incentive design-, Digital Twins models -for improved consumer predictability-, multi-layered P2P DLT/blockchain/ smart contracts based semi-decentralized VPPs -for capturing intra-community interaction dynamics, value stacking flexibility management algorithms and other AI data-driven energy and non energy services at the interplay among energy (power, heat, gas), mobility, health (comfort), smart home (AAL, personal safety).

Scope. The proposed approach and the underlying enablers will be deployed and validated in 4 demo-sites across 4 EU countries in Belgium, Italy, Slovenia and Greece, where around 1000 mostly residential consumers will be engaged along a variety of different community configurations (LEC, CEC, Virtual Energy Communities, Communities on the Move)

Technical description and implementation.

BRIGHT will develop and deploy an ensemble of leading-edge digital technologies, by leveraging on IoT, AI-based big data, DLT/Blockchain, to support new community-enabled ways for engaging consumers in DR. In doing so, BRIGHT will provide the means to enact energy cooperatives, Local Energy Communities and peer-to-peer sharing/trading mechanisms, whose effectiveness will be validated along the proposed field pilots.

BRIGHT will combine leading technology enablers from relevant H2020 projects to develop social and technological tools for hybridizing DR and other energy and non-energy services, which builds on around 2000 end consumers out of which 670 directly involved in pilots and recruited through awareness workshops. BRIGHT will upscale and validate Digital Twins models for electricity residential and non-residential (tertiary, commercial, industrial, self-consumption of locally generated renewable energy) individual and community consumers which couple data-driven AI-based ML models for end user community with flexibility assets data-driven models along a different dimension to increase consumption predictability.

Impact. *Replicability:* the co-creation approach will explicitly design user experience, identify end user

behavioral change motivations and will put end user in a community and social context, with a view to identify the most important social dimensions, hence designing end user incentive as well as the magnitude of such incentive. In doing so, BRIGHT will identify replicable patterns for incentive design, where the context (location, climate, sex, gender, and other levers) under which a given incentive could be working in other similar situation, hence guaranteeing a larger replication of the best practices as well.

Socio-economics: the local aggregation mechanisms and tools will allow to mitigate energy poverty of some members at community level by leveraging on a voluntary energy demand shift or reduction by other members, which gain “immaterial” benefits, aka token, which could be used to offset energy bills and other energy services cost, through tokenized cross-domain neutral sharing marketplace. This decentralized mechanism will allow to link effect of increased DR mobilization with increased accessibility of energy services for people exposed to energy poverty.

Environment: the ensemble of data-driven AI-based energy services will include energy efficiency and flexibilization optimized mobilization

Market Transformation: data-driven mechanisms will provide commercial operators with more reliable estimation of electricity consumption. Appropriate models for home or residential buildings will enable aggregators to develop effective services for the valorization exploitation of the available flexibility.

Policy: the privacy-preserving self-enforcing smart contracts in order to manage appropriately the risk for insufficient data protection and consumer privacy infringement due to data breach and incidents.



H2020 call: LC-SC3-EC-3-2020 – Consumer Engagement and Demand Response

[Back to projects' list](#)

HESTIA

Holistic dEmand response Services for European residenTIAL communities



HESTIA aims to develop a cost-effective solution for the next-generation demand-side response services. The key will be to encourage residential consumers to engage in flexibility sharing and grid balancing. According to HESTIA, user-personalized services will help lay the foundation for an open marketplace and new grid reality

From 2020	Project total cost	EU contribution	Website
To 2023	7.5 M€	5.9 M€	www.hestia-eu.com

Technologies and services deployed		Project partners' countries
	Technologies for consumers	
	Demand response	
	Smart metering	
	Grid technologies	
	Network management and control tools	
	Large-scale storage technologies	
	Distributed storage technologies	Batteries
		EVs
	Generation technologies	PV
		Micro-generation
	Market	Electricity market

Coordinator SINLOC – Sistema Iniziative Locali (IT)

Other partners:

- AXPO ENERGY SOLUTIONS ITALIA - S.p.a. (Italy)
- ELECTRICITE DE FRANCE (France)
- AIT AUSTRIAN INSTITUTE OF TECHNOLOGY GMBH (Austria)
- R2M SOLUTION SPAIN SL (Spain)
- ENERGIES 2050 (France)
- MUNSTER TECHNOLOGICAL UNIVERSITY (Ireland)
- AALBORG UNIVERSITET (Denmark)
- I. LECO (Belgium)
- DUNENWORKS BV (Netherlands)
- FOR YOUR ENERGY FREEDOM BV (Netherlands)
- INSTITUT MIHAJLO PUPIN (Serbia)
- ALBEDO ENERGIE (France)
- COMMUNAUTE D'AGGLOMERATION COMMUNAUTE PARIS-SACLAY (France)
- GRID ABILITY SCARL (Italy)
- MIDAC SPA (Italy)
- DEVELCO PRODUCTS AS (Denmark)
- EUROPEAN INNOVATION MARKETPLACE ASBL (Belgium)
- ASSOCIACIO CLUSTER DIGITAL DE CATALUNYA (Spain)



Project description

Context. Ensuring secure and affordable energy supply to EU citizens is a top priority and purpose of an integrated energy market. This is especially true in a world that is becoming increasingly connected, and where energy consumers demand innovative technologies. It is within this energy ecosystem that HESTIA project is developing a cost-effective solution for the next-generation demand-side response services. The key will be to encourage residential consumers to engage in flexibility sharing and grid balancing. According to HESTIA, user-personalised services will help lay the foundation for an open marketplace and new grid reality.

Scope. HESTIA aims to provide a cost-effective solution for the next-generation DR services which will leverage the consumer engagement, energy and non-energy services, while dealing with both energy supply and demand side in a holistic manner. HESTIA intends to engage with residential consumers, while enabling them to play an active role in flexibility sharing and grid balancing. HESTIA will be demonstrated in 3 different residential pilot setups, in Italy, Netherlands and France, with different infrastructural, climatic, market and regulatory contexts, enabling different business models and levels of provided energy services, across different social categories of consumers.

Technical description and implementation. HESTIA will enable residential DR services through:

- exploitation of energy demand flexibility by engaging the consumers in demand-side management activities,
- valorisation of energy efficiency in multi-carrier energy dispatching and optimal operation of building systems.

HESTIA will exploit the consumer engagement as part of cooperative DR strategy at the community level. HESTIA will involve the residents in the designing of the solution through participatory co-design processes. In addition, HESTIA will exploit the aggregated energy resource flexibility at the demand-side, in terms of cumulative energy consumption, distributed energy generation and storage, to better manage the disparity between energy demand, RES availability and grid requirements. User-personalized services will be delivered via a fully service-oriented, flexible ICT platform, underpinned by agent-based concepts, consumer digital twin and non-intrusive data analytics. This way, HESTIA will set the foundation for an open marketplace and a new grid reality, while steering consumer engagement according to the grid requirements and promoting RES and sustainable behaviour.

Impact. Replicability: This will be achieved by leveraging the agent-based concepts. The underlying optimisation approach is also suitable for multi-user scenarios enabling the identification of optimal interaction between the users. These concepts will contribute directly to high scalability and replicability potential, while creating the opportunities for fast up-take of services within the residential sector. Moreover, this will be facilitated owing to the truly non-invasive solution provided by HESTIA.

Socio-economics: HESTIA is aiming to transform residential customers from static consumer into active participants in the energy sector. The vision is to establish

an open flexibility marketplace where community residents can trade and share their energy and flexibility.

Environment: HESTIA will be dedicated to reduction of GHG and air pollutants emission while delivering the proposed energy services for residential communities. Leveraging the multi-objective optimisation approach as one of its core services, HESTIA will embed the emission reduction as one of its objectives under the optimisation.

Market Transformation: Under the cooperative DR strategy, HESTIA will enable sharing of produced energy and demand flexibility among the residents. This will be achieved by establishing the open flexibility marketplace, deployed on top of the distributed ledger LES platform which will enable automated DR settlements and interaction of prosumers.

Policy: HESTIA will analyse, also within the BRIDGE initiative, the current regulatory frameworks to lift any barriers lifted to steer the necessary evolutions or to avoid potential hurdles at national level.

Social: HESTIA will create 20-50 skilled jobs during the project, increase social benefits related to energy cost reduction, and improve health by integrating assisted living services.

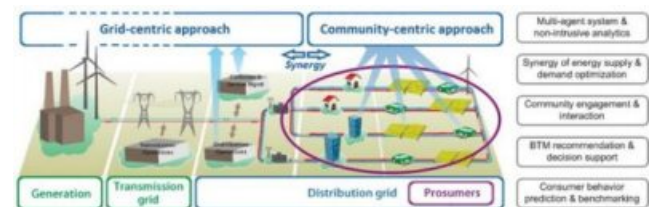



H2020 call: LC-SC3-EC-3-2020 - Consumer engagement and demand response

[Back to projects' list](#)

iFLEX

Intelligent Assistants for Flexibility Management



The project aims at developing the iFLEX Assistant, a novel software agent that acts between consumer(s), and their energy systems, various stakeholders and external systems helping them to achieve mutual benefits through local energy management and Demand Response.

From Nov 2021	Project total cost	EU contribution	Website
To Oct 2024	6.3 M€	5.0 M€	https://www.iflex-project.eu

Technologies and services deployed		Project partners' countries
	Technologies for consumers	
	Grid technologies	
	Large-scale storage technologies	
	Distributed storage technologies	
	Generation technologies	
	Market	
	Demand response Smart Homes	
	Electric Vehicles	
	PV	
	Incentives	

Coordinator VTT - Teknologian tutkimuskeskus VTT Oy (Finland)

Other partners:

- SMART COM DOO INFORMACIJSKI IN KOMUNIKACIJSKI SISTEMI (Slovenia)
- EMPOWER IM OY (Finland)
- INSTITUT JOZEF STEFAN (Slovenia)
- ATHENS UNIVERSITY OF ECONOMICS AND BUSINESS - RESEARCH CENTER (Greece)
- INTRACOM SA TELECOM SOLUTIONS (Greece)
- ELEKTRO CELJE D.D. (Slovenia)
- CAVERION SUOMI OY (Finland)
- IN-JET APS (Denmark)
- ECE D.O.O. (Slovenia)
- IRON THERMOILEKTRIKI ANONYMI ETAIREIA (Greece)
- OPTIMUS ENERGY S.A (Greece)
- ZVEZA POTROŠNIKOV SLOVENIJE DRUSTVO (Slovenia)



Project Description

Context. The consumption and production in energy systems must be in balance at all times. In the European energy system, this balance is mainly managed by controlling power generation so that it matches the power demand. However, this status quo is gradually changing due to the increase of renewable energy sources (RES) deployed across the European energy system. The generation of RES such as photovoltaics (PV) and wind turbines is typically highly variable and difficult to forecast. Additionally, RES generation cannot be controlled in the same way as traditional power plants, which means that the demand-side becomes increasingly important for balancing the European energy system.

Scope. Consumers have a key role as they control a large share of flexible resources that can be used for balancing the European energy system with Demand Response (DR) programs and various aggregation methods. Recent advances and increasing popularity of automation and Information and Communication Technologies (ICT) have opened new possibilities for empowering consumers with innovative flexibility management services. Advances in Artificial Intelligence (AI) technologies such as deep learning (DL) in turn enable development of autonomous systems that adapt to consumers by learning their behaviour and dynamics of energy systems. Together these advances make it possible to develop intelligent assistants for consumer flexibility management that optimize the comfort, energy costs and environmental footprint on consumers behalf and according to their wishes, while at the same time offering the flexibility for power grid management purposes. The development and validation of such intelligent assistants for flexibility management, referred to as iFLEX Assistants, is the main goal of the iFLEX project.

Technical description and implementation. An innovative concept of software agent that facilitates consumer participation in demand response will be designed, implemented and packaged as a general-purpose software framework. The iFLEX Framework is a collection of libraries, tools and configuration scripts that provide the means for developing application-specific iFLEX Assistants that learn consumer behaviour and the dynamics of relevant energy systems in order to optimize and personalize flexibility management.

iFLEX in a nutshell aims to:

- Enable consumers/prosumers to become key market actors by providing solutions for automating and personalizing demand response and holistic energy management.
- Enable secure, private and interoperable data exchange for demand response, following the principles of privacy and security by design and by default.
- Design sustainable business models for energy utilities, aggregators, technology providers and facility managers that enable consumers/prosumers to become key market players in the European energy system.

- Validate the iFLEX Assistant, associated innovations, and incentive models through active end-user engagement in multi-site demonstrators.
- Promote and facilitate the adoption of the iFLEX Assistants as the next-generation user-centric flexibility management solution within and beyond the EU.

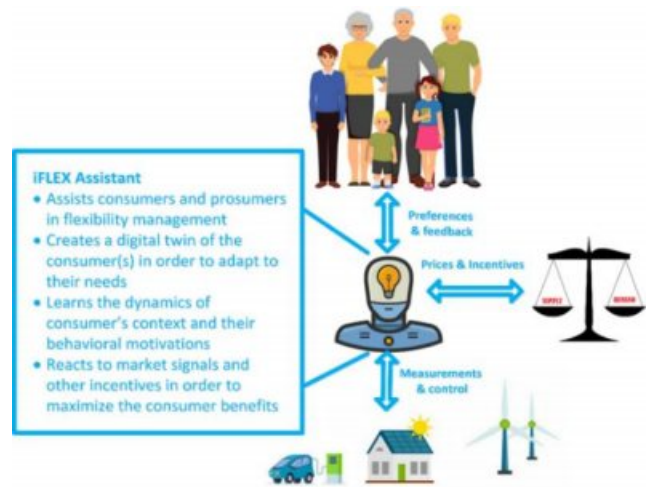

Impact. The project develops iFLEX Assistants that will be core components in empowering end-users in a variety of DR and holistic energy management services demonstrated in operational environment (TRL7) via pilots in Finland, Greece and Slovenia. The common iFLEX Framework and the application-specific iFLEX Assistants will be developed by building on top of existing baseline solutions that start from TRL5-TRL9.



H2020 call: LC-SC3-EC-3-2020 – Consumer Engagement and Demand Response

[Back to projects' list](#)

ReDREAM

Real consumer engagement through a new user-centric ecosystem development for end-users' assets in a multi-market scenario



The energy market is rapidly transforming and so is the role of the consumer. Yesterday's passive consumers are central actors in today's energy markets. As new prosumers, energy markets can benefit from their generation, consumption, and storage capabilities. The EU-funded ReDREAM project will enable the effective participation of consumers and prosumers in the energy market.

From Oct 2020 To Sept 2023	Project total cost	EU contribution	Website
	7.2 M€	5.99 M€	www.redream-energy-network.eu

Technologies and services deployed	Project partners' countries
Technologies for consumers Large-scale storage technologies Distributed storage technologies Generation technologies Market	<p>Demand response, energy advisor to improve energy efficiency, social interaction, and gamification.</p> <p>Virtualisation of consumers: consumer twin.</p> <p>Heat pumps, immersion heaters, building temperature control, electric radiators.</p> <p>Batteries, EV, hot water storage (tanks, swimming pools), air storage (buildings), water storage (swimming pools), storage in industrial processes.</p> <p>Optimal integration and virtualization of local and national renewables.</p> <p>Participation and virtualisation of DSO and TSO markets e.g., avoiding constraints and helping in the balancing of the electricity system.</p>

Coordinator

UNIVERSIDAD PONTIFICIA COMILLAS (SPAIN)

Other partners:

- STEMY ENERGY (Spain)
- TIME.LEX (Belgium)
- ENERGETICA S COOP (Spain)
- SOULSIGH DESIGN STRATEGY SL (Spain)
- CIVIESCO SRL (Italy)
- ASSOCIAZIONE BIO-DISTRETTO DELLA VIA AMERINA E DELLE FORRE (Italy)
- RIMOND ENGINEERING PROCUREMENT AND CONSTRUCTION MANAGEMENT SRL (Italy)
- ZELENA ENERGETSKA ZADRUGA ZA USLUGE (Croatia)
- BATH & WEST COMMUNITY ENERGY LIMITED (United Kingdom)
- NATIONAL TECHNICAL UNIVERSITY OF ATHENS - NTUA (Greece)
- COMMUNAUTE D'UNIVERSITES ET ETABLISSEMENTS UNIVERSITE BOURGOGNE- FRANCHE - COMTE (France)
- OMI-POLO ESPANOL SA (Spain)
- EUROPEAN SCIENCE COMMUNICATION INSTITUTE gGmbH (Germany)
- OLIVOENERGY CONSULTING SL (Spain)



Project Description

Context The European Union (EU) is aiming at transforming the energy systems towards a sustainable, low-carbon, and climate-friendly economy, putting consumers at its centre. Buildings play a key role in this transition as they are responsible for approximately 40% of energy consumption and 36% of CO2 emissions in the EU and, on the other hand, for the potential engagement of consumers through demand response (DR) mechanisms.

To enable this transformation, distribution grids will face new paradigms in the ways they operate, relying more on flexible smart grids with the capacity to safely host more renewable energy sources (RES) and integrate new loads, such as the power to heat/cold, the power to gas/liquid and new technologies, as well as electric vehicles (EVs) while advancing in the security of supply and affordability. This global picture asks for the generation of a new concept of a connected ecosystem between energy system players and consumers.

Scope. The ReDREAM project consortium is developing a user-centric ecosystem, which not only will enable the effective participation of the consumers/prosumers in the energy market but also drive a profound change turning traditional company's value chain into a value generation chain, based on the revolutionary **Service-Dominant Logic** paradigm.

As a result, ReDREAM will gain the following competitive advantages, compared to its competing solutions:

- New user-centric ecosystem
- Consumer-engagement through a holistic methodology
- Open co-creation approach
- Open services and virtualization capabilities.

This avant-garde solution will be exhaustively tested in 4 large-scale pilots: located in Castilla y León (Spain), Lazio (Italy), Varaždin (Croatia), and Bath & North East Somerset (UK) and involving **3 climate areas, 744 users and 3.7 GWh/year**.

Technical description and implementation.

ReDREAM's approach will change the current paradigm by maximizing the UX to effectively reach all types of consumers. To achieve this, a new ecosystem will be deployed using previous developments of Stemy Energy and RIMOND.

The ecosystem will rely on **5 structural layers**:

- Consumer engagement strategy
- Open co-creation
- Energy 'social network'
- Virtualisation and Digital Twins
- Open service pool with the catalogue of tools and services for the consumer.

ReDREAM's approach entails different actors, highly heterogeneous data sources, dimensions, backgrounds, goals and multifunctional effects for the underpinning energy system encouraging a new role for the consumers. The viability and universality of the concept will be

demonstrated in several distinct environments, comprised of different types of consumers, climate areas and energy loads. All demo sites cover the overarching goal of putting the consumer at the centre of the energy system through the validation of the full version ReDREAM ecosystem.

Impact. *Replicability:* The consumer engagement strategies, ecosystem, and tools and services will be tested and realised to ensure the potential and replicability of the solution across Europe. After the end of the project, the solution will be replicated in two ways:

- by engaging the remaining members of the demo cooperatives, and involving cooperative's networks such as RESCoop, which will gather alone **over a million users**
- by engaging new users following the exploitation strategy and the envisioned business plan prioritizing the countries involved in the project and according to the status of each country in terms of legislation.

It has been estimated that in 5 years after the project, ReDREAM could sell **11,211 licenses for householders, 4,086 for the tertiary sector and 1,449 for industries**.

Socioeconomics: The ReDREAM ecosystem will provide different tools capable of combining functionalities in terms of energy efficiency, demand response and other services which impact the daily life of the consumer, ranging from energy to non-energy services, related to:

- Mobility
- Health
- Comfort

It is expected that the combination of the two types of services (energy and non-energy) has a take-up rate of 80%. Furthermore, ongoing collaboration with local actors will study how to determine and deal with **energy poverty**.



H2020 call: LC-SC3-EC-3-2020 – Consumer Engagement and Demand Response

[Back to projects' list](#)

SENDER

Sustainable Consumer Engagement and Demand Response



SENDER develops energy service applications for proactive demand response, home automation, convenience, and security in a co-creation process with customers.

From 2020 To 2024	Project total cost	EU contribution	Website
	6.759 M€	5.837 M€	www.sender-h2020.eu

Technologies and services deployed | **Project partners' countries**

	Technologies for consumers	Demand response Smart appliance Smart home Micro-grid	
	Grid technologies	Management and control tools Digital twins	
	Large-scale storage technologies		
	Distributed storage technologies	EVs Thermal Storage	
	Generation technologies	PV	
	Market	Electricity market Ancillary services	

Coordinator | **SMART INNOVATION NORWAY AS (NORWAY)**

Other partners:

- HYPERTECH ANONYMOUS INDUSTRIAL TRADING COMPANY OF INFORMATION AND NEW TECHNOLOGY (Greece)
- TRIALOG (France)
- UNIVERSITY OF APPLIED SCIENCES UPPER AUSTRIA (Austria)
- ECOSERVEIS (Spain)
- WEIZER ENERGY AND RESEARCH CENTRE (Austria)
- PARAGON (Greece)
- AUSTRIAN INSTITUTE OF TECHNOLOGY (Austria)
- CENTRE FOR ADVANCED STUDIES, RESEARCH AND DEVELOPMENT IN SARDINIA (Italy)
- NXTECH (Norway)
- NORWEGIAN UNIVERSITY OF SCIENCE AND TECHNOLOGY (Norway)
- EUROQUALITY (France)
- DISTRIBUTION OF ELECTRICAL ENERGY OF ALGINET (Spain)
- TECHNICAL RESEARCH CENTRE OF FINLAND (Finland)
- QUE TECHNOLOGIES (Greece)



Project Description

Context. As the EU moves towards sustainable energy, co-creation processes are the future for the design of energy service markets. This entails a shift in the balance of power, turning customers into a new generation of collaborators and putting them at the heart of the energy sector. The EU-funded SENDER project will develop energy service applications for proactive demand response (DR), home automation, convenience, and security mechanisms. By engaging customers in a co-creation process, the project will shift DR from a reactive to a proactive approach. Consumer data will be collected and processed to identify typical consumption patterns, mirror them by digital twins (DTs) based on artificial intelligence technologies and aggregate the DTs' supply/demand characteristics.

Scope. The SENDER project is focused on:

- Developing innovative DR and smart home solutions by placing consumers at the centre of the project using a co-creation approach.
- Integrating more renewables into the electricity system by applying innovative DR tools.
- Using consumer data to improve behaviour predictions to create consumer DTs and DR tools.
- Establishing interoperability of system components by testing them in a virtual lab prior to implementing DT and DR tools at three pilot sites targeting mainly households.
- Developing sustainable business models and a roadmap for the deployment of the solution after the project lifecycle using a replicability study approach.

Technical description and implementation. The developments being performed cover two specific areas:

- ICT innovations based on artificial intelligence and machine learning as well as peer-to-peer trading options will lead to an active involvement of new actors, notably household consumers, in local energy markets.
- Business-related innovations will strengthen the consumer role and foster their improved cooperation with DSOs/aggregators in a co-creation process to design, develop and implement a new local energy market.

Impact. Replicability: SENDER applies the project solutions at three demonstration sites with highly diverse characteristics. This strongly increases the replicability potential of the solution all over Europe.

Socio-economics: SENDER puts consumers at the centre of the electricity market by applying consumer engagement strategies. A dedicated co-creation steering group with consumer integration has the potential to increase the number and types of consumers engaged in DR across Europe.

Environment: The customizable, user-specific home automation bundle product developed by SENDER combines DR with energy efficiency applications. The close cooperation with DSOs during the project lifecycle allows

for the provision of flexibility to the grid and increases the hosting capacity for RES.

Market Transformation: SENDER strengthens the market role of consumers based on their higher market integration; so far segmented DR and smart home automation applications are bundled into one integrated product.

Policy: SENDER actively supports smart grid standardization activities and provides recommendations to national and EU regulatory and political decision bodies

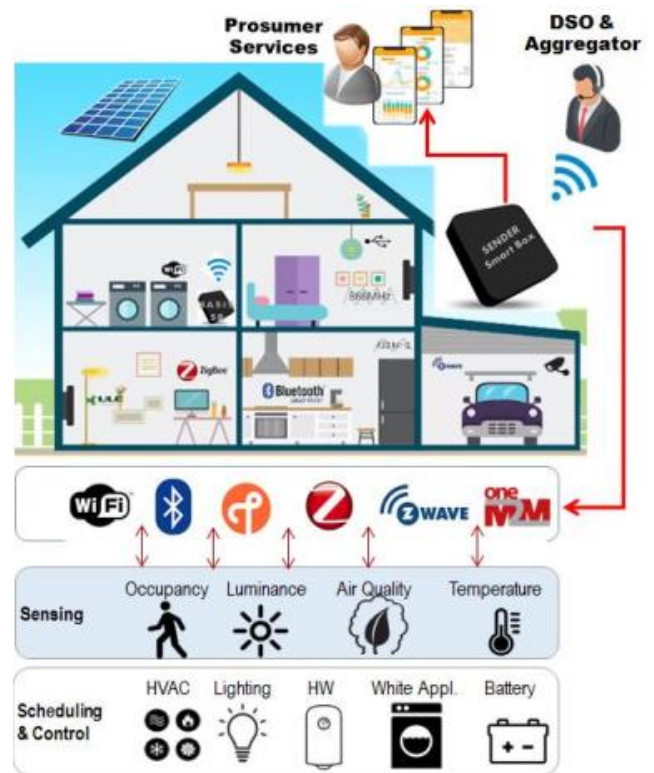



H2020 call: LC-SC3-EC-3-2020 Consumer engagement and demand response

[Back to projects' list](#)







TwinERGY

Intelligent interconnection of prosumers in positive energy communities with twins of things for digital energy markets



TwinERGY will introduce a first-of-a-kind Digital Twin framework that will incorporate the required intelligence for optimizing demand response at the local level without compromising the well-being of consumers and their daily schedules and operations

From 2020	Project total cost	EU contribution	Website
To 2023	7.1 M€	5.9 M€	https://www.twenergy.eu/

Technologies and services deployed		Project partners' countries
	Technologies for consumers	
	Grid technologies	
	Large-scale storage technologies	
	Distributed storage technologies	
	Generation technologies	
	Market	
	Demand response Smart appliances Smart metering	
	Micro-grid	
	Electric Vehicles Batteries	
	Wind Turbine Micro-generation Solar thermal üPV	
	Electricity market Ancillary services	

Coordinator PANEPITIMIO PATRON (GREECE)

Other partners:

- STAM SRL (Italy)
- TECHNISCHE HOCHSCHULE OSTWESTFALEN-LIPPE (Germany)
- UNIVERSIDADE NOVA DE LISBOA (Portugal)
- IES R&D CORDIS NAME (Ireland)
- COMUNE DI BENETUTTI (Italy)
- UNIVERSITY OF BRISTOL (United Kingdom)
- KNOWLE WEST MEDIA CENTRE LBG (United Kingdom)
- SUITES DATA INTELLIGENCE SOLUTIONS LIMITED (Cyprus)
- ETRA INVESTIGACION Y DESARROLLO SA (Spain)
- WORLD ENERGY CONSORTIUM PLC (Malta)
- MYTILINAIOS ANONIMI ETAIREIA (Greece)
- BRISTOL CITY COUNCIL (United Kingdom)
- EUROPEAN DYNAMICS LUXEMBOURG SA (Luxembourg)
- STADT STEINHEIM CORDIS NAME (Germany)
- IDEAS 3493 SL (Spain)
- ARTHUR'S LEGAL BV (Netherlands)
- SMART ENERGY EUROPE (Belgium)



Project Description

Context. The main idea behind the conception of the TwinERGY project lies on the interest of the project partners to exploit the new business opportunities that project implementation delivers and increase the relevance of the Demand Response optimization tools and strategies in the new generation of energy management systems. By coupling mature practice for citizen engagement with service innovation through the lenses of public value, TwinERGY will ensure that a wide range of interests and especially of consumers/ prosumers will be represented and supported in the energy marketplace.

Scope. TwinERGY will develop, configure and integrate an innovative suite of tools, services and applications for consumers, enabling increase of awareness and knowledge about consumption patterns, energy behaviours, generation/ demand forecasts and increase of local intelligence via properly established Digital Twin-based Consumer-Centric Energy Management and Control Decision Support mechanisms that locally optimize demand response. Key use cases will be trialed across 4 pilot regions making use of cutting-edge methods and tools. Special focus will be given on standardization and policy & market reform as key enablers for the successful commercialization of the TwinERGY results.

Technical description and implementation. The TwinERGY interoperable infrastructure (ecosystem) will constitute the backbone for all demonstrators' support and will assure the replicability and scalability potential of the proposed solution. TwinERGY comprises of:

- A Components and Communication layer, which provides the means to collect data being generated by the employed sources of TwinERGY architecture
- An Information layer, at the heart of which lies the Core Data Management Platform (CDMP). This layer brings into the TwinERGY platform the content of the multiple data sources
- A Function layer, that will act as a virtual working space for the different tools and applications of the architecture, to consume datasets through the CDMP and run according to the functions envisioned in the different use cases and the offered services
- A Business layer, that will allow for the first time the creation of a decentralized mass market structure on a large scale to actually compensate prosumers for participating in energy markets in a local level, which also will solve grid problems and create sustainable outcomes for the benefit of consumers and the society at large
- A vertical Cyber-Security/ Data Privacy layer, that assures end-to-end secure data exchange and manipulation

Impact. *Replicability:* TwinERGY's primary targets are residential and tertiary consumers/ buildings around the EU (including office buildings, university campus and retail stores) that represent over 99.9% of the European building stock. Hence, TwinERGY open, modular and plug and play

solution, presents not only a high replicability potential but also a huge business opportunity if appropriate engagement strategies are applied.

Socio-economics: Nearly 11% of the EU's population is in a situation where they are not able to adequately heat their homes at an affordable cost. TwinERGY will contribute to effectively tackling this situation, both directly during the project (in demo countries), but also indirectly through the definition of a targeted exploitation strategy, considering energy poverty-affected countries as a primary target.

Environment: Energy consumption in households constitutes a considerable amount of the total energy in use. Changing energy consumption behavior within the household has a great potential to preserve environmental resources, especially if executed collectively.

Market Transformation: In TwinERGY Consumers will be encouraged and empowered to form tribes with one another, exchange views or co-create with firms thus, transforming symbolic systems in the energy market. These new "logics" will change the role of individuals within energy systems 'from the rather passive and individualistic notion of an 'energy consumer', towards a more participative and communitarian notion of an "energy citizen.

Policy: TwinERGY aims at significantly contributing to the short-, mid- and long-term EU energy policy targets and facilitate the realization of multiple benefits mainly focusing on: i) the significant reduction of Green House Gas emissions, ii) the decrease of electricity prices, iii) better electricity market integration, iv) enhanced security of supply and independence from energy imports and v) more democratized energy markets.



H2020 call: LC-SC3-ES-3-2018-2020: Integrated local energy systems (Energy islands)

[Back to projects' list](#)

CREATORS







CREATIng cOmmunity eneRgy Systems



CREATORS

CREATORS is an EU H2020 project that aims at supporting local initiators and local service providers in initiating, planning, implementing and operating a professional Community Energy System (CES) by supporting technical, financial and social processes.

From Sept 2020	Project total cost	EU contribution	Website
To Oct 2023	7.24 M€	5.35 M€	https://www.creators4you.energy/

Technologies and services deployed	Project partners' countries
 Technologies for consumers Smart metering, Application CES-as-a-service	
 Grid technologies Feed low grade waste heat to the district heating networks	
 Large-scale storage technologies Industrial battery	
 Distributed storage technologies Storage for self-consumption, Hydrogen battery, V2G	
 Generation technologies Solar PV, hydropower, V2G	
 Market Electricity price Reduction, flexibility services	

Coordinator

CORDEEL NV (BELGIUM)

Other partners:

- ACRONI PODJETJE ZA PROIZVODNJO JEKLA IN JEKLENIH IZDELKOV DOO (Slovenia)
- AUTORITAT PORTUARIA DE BARCELONA (Spain)
- BAX INNOVATION CONSULTING (Spain)
- BLAGOVNO TRGOVINSKI CENTER DD (Slovenia)
- COMSA INSTALACIONES Y SISTEMAS INDUSTRIALES (Spain)
- ELECTRO GORENJSKA PODJETJE ZA DISTRIBUCIJO ELEKTRICNE ENERGIJE DD (Slovenia)
- ENERGYPOLE CARAIBES (Spain)
- ENERGYPRO LIMITED (UK)
- FOR YOUR ENERGY FREEDOM BV (Netherlands)
- I.LECO (Belgium)
- INSTITUTE JOSEF STEFAN (Slovenia)
- MITTETULUNDUSUHING TARTU REGIOONI ENERGIAGENTUUR (Estonia)
- R2M SOLUTION SPAIN SL (Spain)
- TAJFUN HIL DRUSTVO SA OGRANICENOM ODGOVORNOSCU ZA ISTRAZIVANJE, PROIZVODNJU, TRGOVINU I USLUGE NOVI SAD (Serbia)
- TARTU LINN (Estonia)
- TURBULENT (Belgium)



Project Description

Context. Although they're generating a lot of interest, smart energy community models are still experimental. Reaching perhaps 0,01% of the current energy market through pilots with less than 100 members & covering usually only one energy vector at the time.

To move a step forward in the development of CES, it is required to move from inventor-driven to a more dynamic and accessible model for integrators and local energy providers and thus, overcome the barriers of scalability, replicability, reliability and viability.

CREATORS aims to accelerate the integration across Europe by supporting local actors throughout the entire life cycle of a CES and bring "CES-as-a-service" models to a commercial readiness level.

Scope. Enable energy communities and local energy service providers across Europe

- Accelerate the integration of CES across Europe
- Enhance commercial readiness of CES
- Unlock local renewable energy generation
- Increase flexibility and local grid balancing
- Activate and empower consumers and prosumers

Technical description and implementation. CREATORS will deliver a set of applications and service packages to support local initiators in the deployment of CES.

- The applications and service packages provided will be developed and demonstrated in four pilot sites located in Belgium, Estonia, Slovenia and Spain and later tested in six following sites under different market conditions.
- The services will deliver 60% preparation and operational costs reduction.
- 20-35% CAPEX reduction
- 5-10% local energy price reduction
- Creation of 2 fte jobs in each CES
- The application will mature from TRL 6 to TRL8-9
- Move from CRL 2 to CRL 3

Impact. Replicability: Since the tool will be demonstrated in 4 projects and replicated in 6 following sites, it will cover different energy community types and different regulatory frameworks, setting the basis for future replicability

Socio-economics: it will empower consumers and prosumers and activate around 15-20% of them in the market.

Environment: Unlock local RES generation and improve the efficiency of the local energy system. Reduction of potentially 1,8 Mton of CO2 per year.

Market Transformation: CREATORS will incentivise the creation of energy communities by delivering easy-to-use tools into a CES-as-a-service package. These tools will be tested in 10 sites, and it expects to create market pull effect.

Policy: CREATORS will try to contact and engage with local key stakeholders for the creation of CES. Some of these key stakeholders are energy agencies, energy regulators and DSO-TSO, and thus it might impact the energy policy of the different CREATORS' countries and create a suitable environment for CES development.





H2020 call: LC-SC3-2018-2019-2020: Integrated local energy systems
(Energy islands)

[Back to projects' list](#)

eNeuron

Green Energy HUBs for Local Integrated Energy Communities optimisation



eNeuron project intends to develop innovative solutions for the best design and performance of local energy communities, integrating distributed energy resources and multiple energy carriers at different levels under the energy hub concept.

From 2020 To 2024	Project total cost	EU contribution	Website
	6.3 M€	5.7 M€	https://eneuron.eu/

Technologies and services deployed		Project partners' countries
Technologies for consumers	Demand response Smart appliances Smart metering	
Grid technologies	Network management, tools Micro-grid	
Large-scale storage technologies		
Distributed storage technologies	Batteries Electric Vehicles Thermal Energy Storage	
Generation technologies	Wind turbine PV Solar thermal Micro-generation	
Market	Electricity market Ancillary services	

Coordinator ENEA (Italy)

Other partners:

- Technical Coordinator: UNIVERSITY OF CYPRUS (Cyprus)
- INSTYTUT ENERGETYKI (Poland)
- FUNDACIO INSTITUT DE RECERCA DE L'ENERGIA DE CATALUNYA (Spain)
- SINTEF ENERGI AS (Norway)
- FUNDACION TECNALIA RESEARCH & INNOVATION (Spain)
- European Distributed Energy Resources Laboratories e.V. (Germany)
- EPRI EUROPE DAC (Ireland)
- UNIVERSITÀ POLITECNICA DELLE MARCHE (Italy)
- UNIVERSIDAD POLITECNICA DE MADRID (Spain)
- ENEA OPERATOR SP ZOO (Poland)
- SKAGERAK NETT AS (Norway)
- LABELLEC - ESTUDOS, DESENVOLVIMENTO E ACTIVIDADES LABORATORIAIS SA (Portugal)
- FONDAZIONE ICONS (Italy)
- ENEIDA WIRELESS & SENSORS SA (Portugal)
- MINISTERIO DA DEFESA NACIONAL (Portugal)
- MIASTO BYDGOSZCZ (Poland)



Project Description

Context. eNeuron project aims to develop innovative tools for the optimal design and operation of local energy communities (LECs) integrating distributed energy resources and multiple energy carriers at different scales. This goal will be achieved, by having in mind all the potential benefits achievable for the different actors involved and by promoting the Energy Hub concept, as a conceptual model for controlling and managing multi-carrier and integrated energy systems in order to optimize their architecture and operation. In order to ensure both the short-term and the long-term sustainability of this new energy paradigm and thus support an effective implementation and deployment, economic and environmental aspects will be taken into account in the optimization tools through a multi-objective approach.

Scope. eNeuron's proposed tools enable tangible sustainability and energy security benefits for all the stakeholders in the LEC. Local prosumers (households, commercial and industrial actors) stand to benefit through the reduction of energy costs while leveraging local, low carbon energy. Developers and solution providers will find new opportunities for technologies as part of an integrated, replicable operational business model. Distribution system operators (DSOs) benefit from avoiding grid congestion and deferring network investments. Policy makers benefit from increasingly sustainable and secure energy supply systems. eNeuron is a high TRL project and proposes innovative approaches and methodologies to optimally plan and operate integrated LECs through the optimal selection and use of multiple energy carriers and by considering both short- and long-run priorities.

Technical description and implementation. eNeuron will develop a cloud-based tool with a web-based user interface for the long-term design optimisation of multi-carrier local integrated energy systems, aiming at identifying the optimal architecture of such systems, in terms of optimised configuration alternatives through a multi-objective approach to account for both technical, economic and the environmental priorities / objectives. The eNeuron tool will also deal with the optimal daily operation of the integrated systems through a stochastic approach and the simulation of peer-to-peer energy trading to investigate the feasibility and convenience of the optimised scheduling strategies from the prosumers point of view in a local real time market employing block chain technology. This integrated approach will allow offering a set of functionalities for LEC (e.g. minimizing CAPEX through optimal investments on RES and other assets), operators (e.g. local congestion management) and prosumers (e.g. activate demand response and energy sharing). The technical solutions developed will be put to the test at four pilot sites in Europe: a city and its major energy nodes (Bydgoszcz, Poland), a football stadium and its vicinity (Skagerak, Norway), a naval district with its own distribution grid (Lisbon, Portugal), and a university campus spread over several sites (Ancona, Italy). The

ultimate objective is to check the effectiveness of the eNeuron solutions to be replicable and scalable, ready to be adapted to different local contexts in Europe.

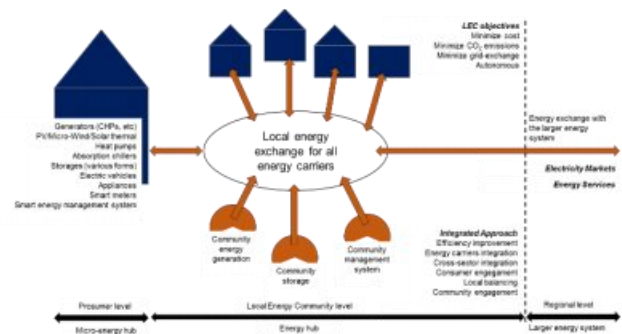

Impact. Replicability: eNeuron focuses on technology demonstration, as well as on the market viability and the replicability of the developed tools and the targeted subcomponents (products and services).

Socio-economics: eNeuron solutions aim to empower European citizens to consume energy more responsibly and at lower prices, while engaging them in the context of LEC by contributing to energy savings and providing flexibility to the grids.

Environment: Through the multi-objective approach proposed for the optimal design of the integrated LEC, eNeuron takes into account the environmental priority in terms of reduction of CO2 emissions, thereby ensuring the long-run sustainability of this new energy paradigm.

Market Transformation and Policy: eNeuron will propose new business models based on the LEC concept. Moreover, eNeuron is committed to making a major contribution to the BRIDGE initiative under different prisms as feedback on the ongoing policy developments in areas of local energy communities. eNeuron is also already supported by EERA and will provide insights to ETIP SNET on the energy transition.



H2020 call: LC-SC3-ES-3-2018-2020 Integrated local energy systems
(Energy islands)

[Back to projects' list](#)

REnergetic

Community-empowered Sustainable Multi-Vector Energy Islands



REnergetic aims to demonstrate the improvement of efficiency and energy autarky, the community involvement and the socio-economic viability of the Energy Islands.

From 2020	Project total cost	EU contribution	Website
To 2024	6.6 M€	5.9 M€	http://www.renergetic.eu

Technologies and services deployed		Project partners' countries
	Technologies for consumers	
	Grid technologies	
	Large-scale storage technologies	
	Distributed storage technologies	
	Generation technologies	
	Market	
	Demand response, smart metering HVAC, Micro-grid Batteries, EVs a Thermal Energy Storage PV, Solar thermal, Biogas, Micro-generation Electricity Market Ancillary Services	

Coordinator INETUM ES (SPAIN)

Other partners:

- Inetum (Spain, France, and Belgium)
- Clean Energy Innovative Projects (Belgium)
- Gent University (Belgium),
- Poznan University of Technology, (Poland)
- Veolia (Poland)
- Poznan Supercomputing and Networking Center (Poland)
- Ospedale San Raffaele (Italy)
- Comune di Segrate
- University of Pavia (Italy),
- Energy Kompass GMBH (Austria)
- University of Mannheim and Passau (Germany).



Project Description

Context. RENergetic was conceived in the context of the 'The European Green Deal', placing the consumer at the heart of the energy transition. Taking advantage of Citizen Energy Communities ('CEC') and 'Renewable Energy Communities' ('REC') as legal entities, these communities are actively controlled by their members, with a primary objective to provide environmental, economic and social community benefits. These communities can help to increase (1) the share of renewables in local areas with limited impact on the public grid and (2) the energy efficiency of the local energy systems, e.g. by a combined optimization of different energy vectors (electricity, heat and waste treatment).

Scope. The following main measurable objectives have been identified for RENergetic

- To securely maximize the level of energy autarky of a local energy system (energy island) and its share of renewable energy sources at energy consumption, at the same time.
- To create energy island communities with formal underpinnings and a high level of personal identification that support a high intake of renewable energy sources in autark energy islands.
- To enhance the economic attractiveness of renewable-based and autark local energy systems (energy islands).
- To ensure a high replication potential of the RENergetic solution across Europe with a special focus on the opportunities offered by local energy island communities.

Technical description and implementation.

RENergetic takes three urban energy islands to demonstrate its viability:

San Raffaele Hospital and its I&R Campus in Segrate Municipality – Milan, Italy, will be working on balancing power and temperature levels of heat and electricity, and their transfer between remote PV plant and campus, and in between campus buildings.

New Docks, a residential area in Ghent – Belgium, will be working on the Integration towards a full and sustainable smart renewable energy system, including PV, waste heat and water recovery, as well as efficient battery storage.

Warta University Campus and Poznan Supercomputing and Networking Center Poznan – Poland, optimising specific and total demand-supply relationships, taking into account smart EV charging and building energy monitoring.

Impact. Replicability: RENergetic has a dedicated Work Package for replicability and it will capitalize on the experiences from the project pilot sites, their difficulties, barriers and successes, and will develop a complete replicability package that will serve as a reference for other energy islands implementation initiatives.

Socio-economics: RENergetic will help to engage the local citizens to become active contributors to a clean energy society and to influence other consumers to adopt similar behaviour.

Environment: Using IA-based-energy optimizers will have a great environmental impact, increasing the use of renewables, thus lowering the dependency on fossil fuels energies.

Policy: RENergetic will consider legal viability and propose mitigation measures for identified legal hurdles.

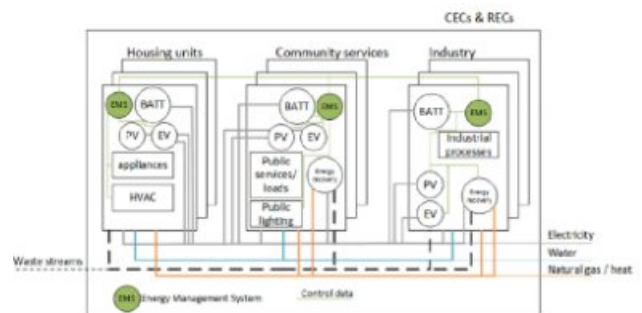



H2020 call: LC-SC3-ES-10-2020 DC – AC/DC hybrid grid for a modular, resilient and high RES share grid development

[Back to projects' list](#)





HYPERRIDE

Hybrid Provision of Energy based on Reliability and Resiliency by Integration of Dc Equipment

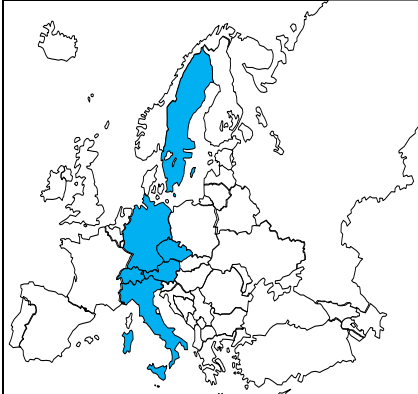

HYPERRIDE contributes to the field implementation of DC and hybrid AC/DC grids. Grid planning and operation guidelines are developed, and available sizing tools adapted for DC. TRL of enabling technologies will be raised focused on MVDC breakers, sensors and DC measurement units to provide field ready devices for grid automation and protection. Automation algorithms are created, validated and transferred to demo sites. This involves concepts and solutions for cyber security and fault mitigation to avoid cascading effects. Demonstrations in Aachen (DE), Lausanne (CH), Terni (IT) will showcase above-mentioned technologies. Benefits of the solutions are evaluated, especially the integration potential of renewables. Business models are created for products, services and applications.

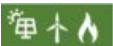
From 2020	Project total cost	EU contribution	Website
To 2024	8.2 M€	7.0 M€	www.hyperride.eu

Technologies and services deployed		Project partners' countries
 Grid technologies	MVDC, VDC circuit breakers Protections Network management, monitoring and control tools Micro-grid Multi-terminal	
 Large-scale storage technologies		
 Distributed storage technologies	Batteries, Electric Vehicles	
 Generation technologies	PV	
 Market	Electricity market Ancillary services	

Coordinator AIT AUSTRIAN INSTITUTE OF TECHNOLOGY GMBH (AUSTRIA)

Other partners:

- SCIBREAK AB (Sweden)
- RHEINISCH-WESTFAELISCHE TECHNISCHE HOCHSCHULE AACHEN (Germany)
- EATON ELEKTROTECHNIKA SRO (Czech Republic)
- ECOLE POLYTECHNIQUE FEDERALE DE LAUSANNE (Switzerland)
- DR. TECHN. JOSEF ZELISKO FABRIK FUR ELEKTROTECHNIK UND MASCHINENBAU GMBH (Austria)
- ENGINEERING - INGEGNERIA INFORMATICA SPA (Italy)
- ASM TERNI SPA (Italy)
- FLEXIBLE ELEKTRISCHE NETZE FEN GMBH (Germany)
- EMOTION SRL (Italy)



Project Description

Context. With increasing contributions from internal direct current (DC) based renewable energy sources, electromobility and battery storages, low-voltage DC grids or DC coupled with AC in a hybrid network could enable more stable, efficient and sustainable electricity distribution at lower costs. The proposed solutions in HYPERRIDE will contribute to

- facilitating planning and targeting investments in the sector;
- increasing resilience of the electricity grid to faults and cyberattacks;
- increasing penetration of renewable energy resources (RES) in the power network;
- increasing the efficiency of the electricity system (system level).

HYPERRIDE project is developing the technologies to make this possible with planned demonstrations in a variety of use cases. All this will be accompanied by business models for the resulting products, services and applications.

Scope. The main objective is to demonstrate MV – LVDC – AC/DC hybrid grid architectures based on a DC underlay grid interconnecting micro/nano-grids on target Technology Readiness Level (TRL) 5-8. This includes i.a. the following further objectives:

- Planning, operation and automation solutions, incl. operation on and separated from main AC grid;
- Development of enabling technologies, i.a. MVDC Circuit Breakers and Sensors, DC Measurement Unit, open interoperable ICT platform, open reliability database, test and validation services;
- Fault management and cybersecurity solutions, incl. protection coordination, stability assessment, and automatic grid reconfiguration;
- Technology demonstrations in three countries by virtually linked demo-sites;
- Effective business models & knowledge transfer, recommendations for standardization and regulation bodies.

Technical description and implementation. Following three demonstrations are planned:

- Demo 1 (Lausanne, CH) and Demo 2 (Aachen, DE): MV – LVDC – AC/DC hybrid campus grids.
- Demo3: LV DC - AC/DC hybrid DSO grids with connection to MVAC grid via AC-transformer in the field.

Impact. Replicability: Modular, techno-economic DSO grid planning approach for the transition of AC to AC/DC hybrid grids including a component sizing tool. Interoperable, open ICT platform, data models for interoperability and open reliability information data base. Configurable MV and LVDC components model library for controls, protection, stability assessment considering several use-cases.

Environment: Enhancing energy efficiency on system level as well as application side and sustainable resource usage (CO2 footprint). DC-Grids enable to connect a higher share

of renewables (PV, wind) and DC-based loads (EVs, heat pumps/cooling systems) to the grid.

Market Transformation: Steadily falling prices of semiconductor-based devices and wide band gap components enable new DC use-cases. A cost benefit analysis (CBA) is carried out for most promising use-cases, development of business models for the deployment of new services. Activities are aligned with other developments to increase the replication potential of the developed solutions for smart grids and energy storage applications (e.g., local energy communities).

Policy: Enhancing energy efficiency and sustainability is a key pillar of most policy initiatives. HYPERRIDE will contribute to BRIDGE and in addition organize best practice exchanges and methodology workshops at demonstration sites where use-cases are discussed with local industrial-style stakeholders. Comparative analysis of legal and regulatory framework (hybrid AC/DC grids) in the countries of the demo sites including policy recommendations (analysis of barriers for promising use-cases).

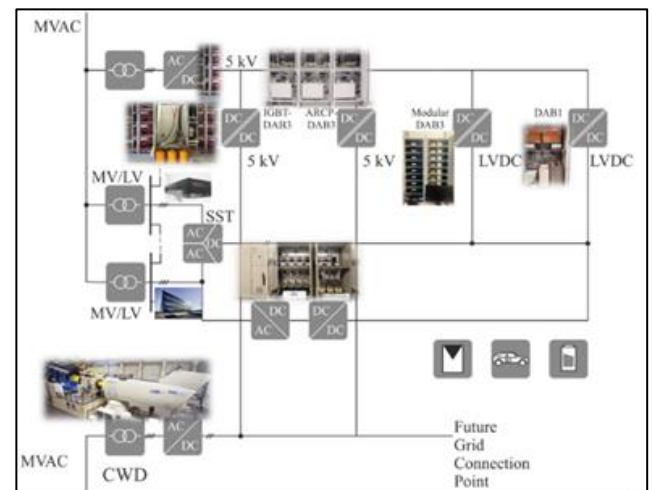

Demo2: RWTH Aachen MV/LVDC Campus grid



H2020 call: LC-SC3-ES-10-2020 DC – AC/DC hybrid grid for a modular, resilient and high RES share grid development

[Back to projects' list](#)







TIGON

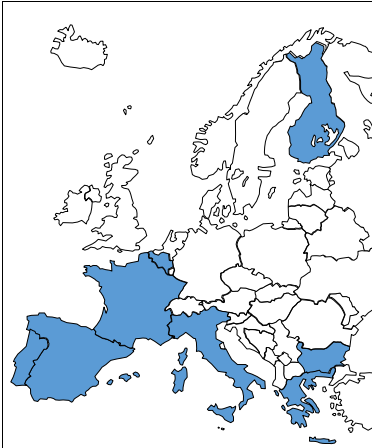

Towards Intelligent DC-based hybrid Grids Optimizing the network performance

TIGON aims to achieve a smooth deployment and integration of intelligent DC-based grid architectures within the current energy system while providing ancillary services to the main network. To do so, TIGON proposes a four-level approach aiming at improving 1) Reliability, 2) Resilience 3) Performance, and 4) Cost Efficiency of hybrid grids through the development of an innovative portfolio of power electronic solutions and software systems and tools focused on the efficient monitoring, control and management of DC grids.

From 2020 To 2024	Project total cost	EU contribution	Website
	8.0 M€	6.9 M€	https://tigon-project.eu/

Technologies and services deployed	Project partners' countries
 Technologies for consumers Demand response Smart appliance Smart metering	
 Grid technologies HVDC Protections Network management and control tools Micro-grid	
 Large-scale storage technologies	
 Distributed storage technologies Batteries Electric vehicles Power to heat	
 Generation technologies Wind Turbine PV	
 Market Electricity Market Ancillary Services	

Coordinator FUNDACION CIRCE CENTRO DE INVESTIGACION DE RECURSOS Y CONSUMOS ENERGETICOS - CIRCE (Spain)

Other partners:

- ETHNIKO KENTRO EREVNAS KAI TECHNOLOGIKIS ANAPTYXIS - CERTH (Greece)
- FUNDACION CARTIF - CARTIF (Spain)
- COMMISSARIAT A L'ENERGIE ATOMIQUE ET AUX ENERGIES ALTERNATIVES - CEA (France)
- CENTRO DE INVESTIGACIONES ENERGETICAS, MEDIOAMBIENTALES Y TECNOLOGICAS - CIEMAT (Spain)
- EFACEC ENERGIA - MAQUINAS E EQUIPAMENTOS ELECTRICOS SA - EFACEC (Portugal)
- UBITECH ENERGY - UBE (Belgium)
- AKUO ENERGY SAS - AKUO (France)
- PREMO S.A.U. - PREMO (Spain)
- HYPERTech (CHAIPERTEK) ANONYMOS VIOMICHANIKI EMPORIKI ETAIREIA PLIROFORIKIS KAI NEON TECHNOLOGION - HYPER (Greece)
- TURUN AMMATTIKORKEAKOULU OY - TUAS (Finland)
- INNOVATIVE ENERGY AND INFORMATION TECHNOLOGIES LTD - IEIT (Bulgaria)
- METROPOLITEN JSC - MetroS (Bulgaria)
- RINA CONSULTING SPA - RINA-C (Italy)
- FONDAZIONE ICONS - ICONS (Italy)



Project Description

Context. Over the last two decades, the high proliferation of RES together with the increase in DC loads linked to the use of electronics, LED lighting and novel technologies such as electric vehicles and energy storage, has increased the attractiveness of DC grids. The main drivers behind this paradigm shift are related to the increase in energy efficiency, less complex control of power quality and seamless integration of renewable energy and energy storage, thus increasing the sustainability of the energy distribution system. However, the lack of DC microgrids prevents them to evolve from a promising solution for future smart grids to a commercially available technology.

Scope. TIGON has been conceived to design, model and develop innovative DC-technologies aiming to improve their reliability, resilience, and performance in a smart and cost-efficient way. In order to do so, a modular concept of DC-based hybrid grid topology is proposed consisting of a MVDC line connecting the main grid through a Solid-State Transformer (SST) with the LV hybrid grid. Based on this concept, TIGON demonstrators located in France and Spain will integrate in a more efficient way distributed RES, energy storage and a variety of loads including electric vehicles. At the same time, the MVDC line will be exploited by integrating a higher amount of RES and providing ancillary services through energy storage systems and their related operation modes and control strategies.

Technical description and implementation. The novelty of this approach relies on the integration of TIGON main physical and software developments, which are the key enablers for the smart and cost-effective operation of the whole DC-based hybrid grid. The main technologies of TIGON Project are:

- Solid State transformer
- SiC DC/DC converters
- MVDC PV plant
- WAMPAC system
- Smart Energy Management System
- Decision Support System tool
- Cybersecurity Defence System

To be able to validate the performance of the solutions, they will be tested in two real microgrid Demo-Sites located in France and Spain, while additional use cases in the residential and urban railway sectors (Finland and Bulgaria) will act as niche markets for analysing and further solidifying the replication of TIGON developments after the project's end.

In the demo-site in France, one of the main challenges for renewable energies penetration into the grid and specifically for solar power is to reduce drastically the LCOE through reducing CAPEX. The pilot will improve the CAPEX of PV plants, through the reduction of cost of electrical equipment: cables, reduction of components through specific topologies and WBG components through the reduction of passive components size, along with an improvement of reliability on a global scale.

In the demo-site in Spain, the increasing share of variable and unpredictable RES connected to the centre is challenging their electricity grid in terms of reliability, stability and security of supply.

Impact. Replicability: TIGON focuses on technology demonstration, as well as on the market viability and the replicability of the TIGON technologies and the targeted subcomponents (products and services).

Socio-economics: The digitalisation of the power system with the deployment of smart grid technologies, upon which TIGON's solutions are built, rises concerns on data security and privacy among both operators and consumers. TIGON will develop a robust defence system to face potential cyberattacks that might damage the system.

Environment: Solutions implemented in TIGON will allow a smoother deployment of DC-based hybrid grid architectures which will transform current and future energy grids in more sustainable, since they improve the energy efficiency of the system and allow for better management and operation of the energy sources thanks also to the reduced number of energy conversion stages. The TIGON emissions reduction is a true benefit and will also serve as motivation for more active engagement in demand-response plans.

Market Transformation and Policy: TIGON will place emphasis in the development of new business models and opportunities will arise due to the dawn of new concepts and systems/tools ideas. Moreover, a dedicated DSS tool facilitating the planning of grid expansions, or the development of new hybrid-grids will be developed during the project.



LC-SC3-ES-4-2018-2020: Decarbonising energy systems of geographical Islands

[Back to projects' list](#)

IANOS

IntegrAted SolutioNs for DecarbOnisation and Smartification of Islands



IANOS aims to demonstrate and replicate the symbiotic operation of various energy streams in EU islands, unlocking their great potential to act as Lighthouses of pan-European decarbonization.

From 2020 To 2024	Project total cost	EU contribution	Website
	8.8 M€	7.0 M€	https://ianos.eu/

Technologies and services deployed		Project partners' countries
	Technologies for consumers	
	Grid technologies	
	Distributed storage technologies	
	Generation technologies	
	Market	
	Demand response Smart appliances Smart Metering	
	Network management Monitoring and control tools	
	Batteries Thermal energy storage Flywheels	
	PV Wind turbines Tidal Energy Biogas	
	Ancillary Services Electricity Market	

Coordinator EDP NEW (PORTUGAL)

Other partners:

- UNINOVA (Portugal)
- EFACEC ENERGIA - MAQUINAS E EQUIPAMENTOS ELECTRICOS SA (Portugal)
- EDA - ELECTRICIDADE DOS ACORES SA (Portugal)
- EFACEC ELECTRIC MOBILITY, SA (Portugal)
- GOVERNO REGIONAL DOS ACORES (Portugal)
- VIRTUAL POWER SOLUTIONS SA (Portugal)
- TERALOOP OY (Finland)
- SUNAMP LIMITED (United Kingdom)
- BEMICRO LDA (Portugal)
- GEMEENTE AMELAND (Netherlands)
- STICHTING NEW ENERGY COALITION(Netherlands)
- ALLIANDER NV (Netherlands)
- SUWOTEC BV (Netherlands)
- AMELANDER ENERGIE COOPERATIE (Netherlands)
- Stichting Hanzehogeschool Groningen (Netherlands)
- NEDERLANDSE ORGANISATIE VOOR TOEGEPAST NATUURWETENSCHAPPELIJK ONDERZOEK TNO (Netherlands)
- NEROA BV (Netherlands)
- REPOWERED BV (Netherlands)
- SEAURRENT HOLDING BV (Netherlands)
- BAREAU BV (Netherlands)
- GASTERRA BV (Netherlands)
- COMUNE DI LAMPEDUSA E LINOSA (Italy)
- CONSIGLIO NAZIONALE DELLE RICERCHE (Italy)
- COMMUNE DE BORA BORA (French Polynesia)
- AKUO ENERGY SAS (France)
- DIMOS NISUROU (Greece)
- ETHNIKO KENTRO EREVNAS KAI TECHNOLOGIKIS ANAPTYXIS (Greece)
- ETRA INVESTIGACION Y DESARROLLO SA (Spain)
- ENGINEERING-INGEGNERIA INFORMATICA (Italy)
- RINA CONSULTING SPA (Italy)
- EUROPEAN RENEWABLE ENERGIES FEDERATION-FEDERATION EUROPEENE DES ENERGIES RENOUVELABLES (Belgium)
- ELLINIKI ETAIREIA ENERGEIAKIS OIKONOMIAS (Greece)
- UBITECH ENERGY (Belgium)



Project Description

Context. Almost 3.5% of European citizens live in geographical islands. Although each island has its own characteristics and challenges, most EU islands face specific energy-related challenges which lead to very high energy costs compared to the mainland. However, opportunities can also arise as, compared to the highly complex mainland energy systems, solutions towards RES integration are easier to deploy and have a significant decarbonization impact on islands' ecosystems.

Scope. IANOS aims to demonstrate, under real-life operational conditions, a group of both technological and non-technological solutions adapted to harsh islandic conditions, in two lighthouse islands: Terceira (Portugal) and Ameland (Netherlands). The project covers a multitude of energy supply, storage and end-use vectors on different climatic and socio-economic conditions, while taking the appropriate measures for their replication into three Fellow islands: Lampedusa (Italy), Bora Bora (French Polynesia) and Nisyros (Greece).

Bringing together 34 experienced partners from 9 European countries, the project will adopt an island energy transition strategy focussed on energy efficiency, decarbonisation through electrification and support from carbon-neutral fuels, and the empowerment of local energy communities.

Technical description and implementation.

IANOS will demonstrate an intelligent Virtual Power Plant (iVPP) based on AI which sets up a virtual network of decentralized renewable energy resources, both non-dispatchable such as wind, solar, tidal resources and dispatchable ones such as geothermal and green gas CHP plants as well as Energy Storage Systems integrated as a single unit, providing flexibility services and fostering island renewable energy self-consumption.

Cross-cutting novel technologies will be demonstrated in the 2 Lighthouse islands in 3 different areas:

- Smart Grid (fog-enabled intelligent device, smart energy router, hybrid transformer)
- Storage (flywheel, biobased saline batteries, heat batteries)
- Renewable Energy (tidal kite, auto generative high-pressure digester).

An Island Energy Planning and Transition Suite (IEPT) toolkit will be introduced to assist key island stakeholders in developing an effective renewable energy portfolio and island decarbonisation plan. The toolkit comprises a crowd equity platform; a dedicated Life Cycle Assessment (LCA) / Life Cycle Costing (LCC) toolkit to further assist in the decision-making process; and a grid-oriented optimiser providing detailed modelling and grid scenarios simulations.

Impact. Replicability: IANOS ensures a large-scale uptake of validated solutions on the same geographical island and/or on other geographical islands with similar problems. The majority of the elements included in IANOS

allows a strong degree of automatization and interoperability.

Socio-economics: IANOS will facilitate the creation and/or increase the number of renewable energy communities.

IANOS is supporting the integration of renewables in existing islands' power systems, avoiding and/or limiting expensive and inefficient investments on new grid infrastructures as far as possible.

Environment: IANOS inherently contributes to decreasing the ecological footprint and improving the carrying capacity of islands by reducing energy needs and increasing energy self-sufficiency.

Market Transformation: Enhanced innovation capacity will enable IANOS to identify and assess new market opportunities. The whole approach of making rich data streams available to a wide potential audience of innovators is designed to generate new services to islanders and businesses.

Policy: IANOS will facilitate the development of an island-wide action plan on clean energy that clearly describes the necessary actions, timeline and budget to achieve each island's vision.



LC-SC3-ES-4-2018-2020: Decarbonising energy systems of geographical Islands

[Back to projects' list](#)

ISLANDER

Accelerating the decarbonisation of islands' energy systems



Islander has the main objective to integrate and operate together heterogeneous storage, electric vehicles and renewables combined in different applications (behind the meter, front the meter, street lighting, ...) to decarbonize Borkum Island. The smart IT platform developed along with the demand and supply forecasting algorithms will be key for monitoring and operating assets installed during the project lifespan. Thanks to the work of follower islands and the optimisation tool to be developed in the project, Borkum results will serve as a showcase and will be able to be replicated in other islands to move forward and reach 2030 climate and energy framework objectives.

From 10/2020	Project total cost	EU contribution	Website
To 09/2024	8.2 M€	6.9 M€	https://www.islander-project.eu/

Technologies and services deployed		Project partners' countries
	Technologies for consumers	
	Grid technologies	
	Large-scale storage technologies	
	Distributed storage technologies	
	Generation technologies	
	Market	
	Demand response, smart metering	
	Microgrids	
	Hydrogen	
	Li-ion batteries, EVs, thermal (district heating)	
	PV	
	Electricity market Ancillary services	

Coordinator **AYESA ADVANCED TECHNOLOGIES SA (Spain)**

Other partners:

- IDENER RESEARCH & DEVELOPMENT AGRUPACION DE INTERES ECONOMICO (Spain)
- STEINBEIS INNOVATION (Germany)
- NORDSEEHEILBAD BORKUM (Germany)
- ZIGOR RESEARCH & DEVELOPMENT (Spain)
- CEGASA ENERGIA (Spain)
- BCM ENERGY (France)
- KATHOLIEKE UNIVERSITEIT LEUVEN (Belgium)
- THE EUROPEAN MARINE ENERGY CENTRE LIMITED (United Kingdom)
- DIKTYO AEI FORIKON NISON TOY AIGAIIOUAE (Greece)
- REGIONALNA ENERGETSKA AGENCIJA KVARNER (Croatia)



Project Description

Context. Borkum is an island of about 30 km² and 5,500 residents, located 20 miles from the north-western coast of Germany. Following concerns of the population regarding air quality due to a new coal fired power plant on the Dutch coast, Borkum started on a path towards renewable energy many years ago. Following several initiatives in that direction including a citizen dialogue and the previous H2020 NETfficient project, the island decided to become emission-free and fully decarbonized by 2030. Yet, the challenges associated with the intermittent nature of power supplied by renewable sources remain: consumption peaks cannot be met readily by solar and wind energy and expensive grid electricity needs to be bought in. Vice versa, peak generation leads to energy exports at unfavourable conditions.

Scope. ISLANDER aims at developing an even more integrated and efficient central energy management platform in order to manage the various energy assets and balance fluctuations between generation and demand, using local flexibility options such as storage technologies and demand response in combination with renewable energy sources. In addition, an innovative concept for heat supply based on a seawater-powered heat pump and a heat storage tank will be installed in a newly built district close to the port of Borkum. A large hydrogen-based storage will also be deployed. Moreover, a Renewable Energy Community will be created in order to engage the citizens of Borkum and strengthen their participation in the island's energy transition. These measures will set the course for the creation of a largely carbon-free energy system on the island of Borkum by 2030.

Technical description and implementation. Within this framework, the ISLANDER project will showcase the process of making Borkum a fully autonomous and decarbonised island energy system. Specifically, the project will focus on delivering:

- Distributed RESS systems (Renewable Energy + Small-scale Storage) composed of household and building roof-mounted PV and Li-ion storage, to involve consumers in the active management of the grid.
- Complementary short-to-seasonal, large-scale electricity storage: peak-shaving fast-response storage (Ultracaps), intra-day storage (Li-ion battery) and seasonal storage (H₂-based storage).
- Seawater district heating coupled with heat storage for residential units, to make use of the thermal capacity of the North Sea water as a source of heating and cooling.
- Deployment of an EV charging network setting up 5 stations to promote the electrification of the island's transport.
- A smart IT platform conceived to holistically perform the optimal aggregation of all these components while also implementing Demand Response (DR) to further balance the energy grid. Multi-scale forecasting through comprehensive modelling of demand and supply will be key for it.

- An optimisation tool to optimally design zero-carbon island energy systems thanks to advanced modelling and optimisation and which will be distributed as an open-source software tool to all interested islands.

Impact.

Replicability: ISLANDER aims to replicate its results to the widest possible adopters. To do so, the project entails a 3-wave replication strategy along with the dissemination measures required to support it: First wave replication in Follower Islands in Great Britain, Greece, and Croatia; Second wave replication in the related archipelagos; Third wave replication in other EU islands by means of the cooperation with the European Islands initiatives.

Market Transformation: The indicators shows that the market potential for the ISLANDER advances exploited as energy services, innovative storage approaches and smart IT platform is very relevant within the EU. Taking full advantage of new business models will require the creation of new companies, the training necessary for the new jobs, and the creation of new regulation.

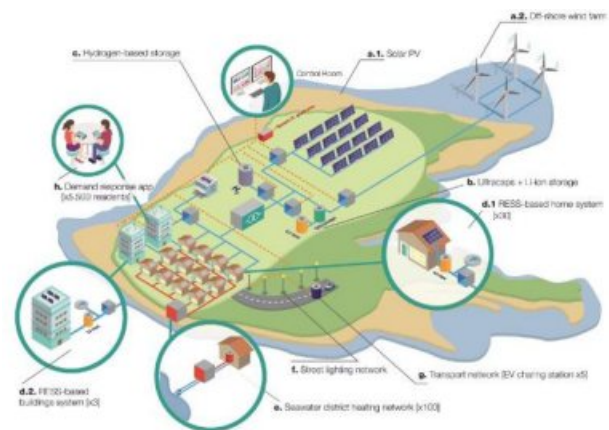



LC-SC3-ES-4-2018-2020: Decarbonising energy systems of geographical Islands

[Back to projects' list](#)

MAESHA

DeMonstration of smArt and fLExible solutions for a decarboniSed energy future in Mayotte and other European isLands



The EU-funded MAESHA project will develop smart and flexible methods of storage and energy management as well as modelling tools and technical systems with the aim of promoting the transition towards sustainable energy. Designed with respect to the interests of the local communities, adapted to the market and ready to be disseminated, the new approaches will serve as a demonstration for the future decarbonisation of the Mayotte and other European islands.

From 2020	Project total cost	EU contribution	Website
To 2024	11.79 M€	8.87 M€	www.maesha.eu

Technologies and services deployed		Project partners' countries
	Technologies for consumers	
	Grid technologies	
	Large-scale storage technologies	
	Distributed storage technologies	
	Generation technologies	
	Market	

Coordinator TECHNISCHE UNIVERSITAT BERLIN (Germany)

Other partners:

- COBRA INSTALACIONES Y SERVICIOS S.A. (Spain)
- CENTRICA BUSINESS SOLUTIONS BELGIUM (Belgium)
- TRIALOG (France)
- E3-MODELLING AE (Greece)
- CYBERGRID GMBH & CO KG (Austria)
- TECSOL (France)
- CREAMA CONSULTORES SL (Spain)
- BOVLABS SAS (France)
- HIVE POWER SAGL (Switzerland)
- HUDARA GGMBH (Germany)
- ELECTRICITE DE MAYOTTE (France)
- ASSOCIATION LEONARD DE VINCI (France)
- COLLECTIVITE DE SAINT-BARTHELEMY (France)
- CONSORCIO PARA EL DISEÑO, CONSTRUCCIÓN, EQUIPAMIENTO Y EXPLOTACIÓN DE LA PLATAFORMA OCEÁNICA DE CANARIAS (Spain)
- COMUNE DI FAVIGNANA (Italy)
- THE GOZO BUSINESS CHAMBER ASSOCIATION (Malta)
- CONFERENCE DES REGIONS PERIPHERIQUES MARITIMES D EUROPE (France)
- GREENINGTHEISLANDS.NET SRL (Italy)
- EUROQUALITY SARL (France)
- TERRITOIRE DES ILES WALLIS ET FUTUNA (Wallis and Futuna)



Project Description

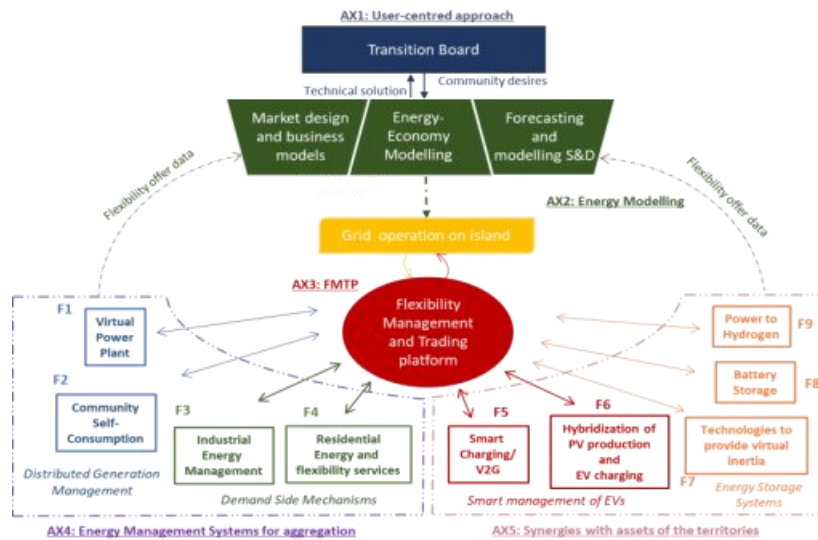

Context. More than 16 million people live on the 2400 islands of the European Union. Although the features of their environments are very diverse, they all face common challenges regarding energy supply. Indeed, due to their high dependency on imported fossil fuels, their energy sectors are extremely polluting, and the lack of interconnections often impacts the resiliency of their networks. Furthermore, the state of their power plants, often aging and lacking efficiency, results in energy costs that can be up to ten times higher for insular inhabitants than on the mainland. But European island geographical conditions often offer high production potential for either solar, wind or biomass technologies. The large penetration of RES would ensure a higher independence, a better security of supply and better grid stability while reducing the costs of energy for households.

Scope. The MAESHA project will decarbonise the energy systems of geographical islands by fostering the large deployment of RES through the installation of tailored innovative flexibility services based on a close study and modelling of local energy systems and community structures. MAESHA will demonstrate the solutions on the French overseas island of Mayotte and study replicability potential on 5 follower islands representing more than 1.2 million inhabitants spread in geographical Europe and overseas territories.

Technical description and implementation. At the core of the MASHA project, a Flexibility Management and Trading Platform (FMTF) will be developed, where different technologies can offer their flexibility. Such technologies include already existing assets, which must be managed and aggregated to operate in a grid-friendly manner, such as residential and industrial appliances and devices, but also innovative technologies, which will be introduced during the project. These include especially smart EV charging station, combined with PV production, seasonal hydrogen storage, battery storage and technologies to provide virtual inertia. The technical solutions and implementations will be accompanied with an iterative consultation process of representative community members, assembled as a Transition Board.

Impact. The MAESHA project will reduce the GHG emission on geographical island energy system and reduce fossil fuel consumption by triggering synergies of relevant energy sectors with a flexible electricity grid. Establishing supporting regulatory frameworks and markets will incentivize the local population to create Local Energy Communities (LECs), increasing the community's participation and influence in the energy transition. Associated market schemes will decrease the population's expenditure on energy consumption, freeing up resources for other goods and thereby improving quality of life and development in multidimensional scope.



LC-SC3-ES-4-2018-2020: Decarbonising energy systems of geographical Islands

[Back to projects' list](#)







ROBINSON

smart integRation Of local energy sources and innovative storage for flexiBle, secure and cost-efficient eNergy Supply ON industrialized islands



Islands often find it challenging to ensure a clean, secure and cost-effective supply of energy. The key is to decrease dependency on fossil fuels and become energy self-sufficient through a mix of renewable energy generation and storage infrastructure. ROBINSON's main mission is to develop an integrated energy system to help decarbonise islands. The system, which will be demonstrated on the island of Eigerøy, Norway, couples locally available energy sources, electrical and thermal networks and storage technologies, using hydrogen as energy carrier. In order to achieve the target, innovative technologies will be developed, integrated on the island and managed by a novel energy management system that will include non-electrical resources such as biomass gasification, wastewater valorisation and industrial symbiosis.

From 10/2020	Project total cost	EU contribution	Website
To 09/2024	8.4 M€	7 M€	www.robinson-h2020.eu

Technologies and services deployed		Project partners' countries
 Technologies for consumers	Demand response, smart metering	
 Grid technologies	EMS	
 Large-scale storage technologies		
 Distributed storage technologies	PEM electrolyser, H2 storage	
 Generation technologies	CHP, Wind turbine	
 Market	Reduction Infrastructure costs	

Coordinator	ETN (Belgium)
--------------------	----------------------

Other partners:

- LEITAT (Spain)
- NORCE (Norway)
- EIGERSUND NAERING OG HAVN KF (Norway)
- Aurelia Turbines (Finland)
- PSI (Switzerland)
- UNIGE (Italy)
- ENERGY INNOVATION AS (Norway)
- DALANE ENERGI AS (Norway)
- REST UG (Germany)
- PRIMA PROTEIN AS (Norway)
- FUNDITEC (Spain)
- HYSYTECH (Italy)
- NORTH HIGHLAND COLLEGE (United Kingdom)
- COMHAIRLE NAN EILEAN SIAR – WESTERN ISLES COUNCIL (United Kingdom)
- POLYTECHNEIO KRITIS - TECHNICAL UNIVERSITY OF CRETE (Greece)
- KRITI – PERIFEREIA (Greece)
- STRATAGEM ENERGY LTD (Cyprus)



Project Description

Context. The islands need clean, cost-efficient and reliable solutions tailored to fit their geographical situation, the fluctuating population and the local economy. Combining the intermittent RES with suitable storage, together with other available dispatchable sources such as biomass, along with a variety of operational strategies such as demand side management and management of all the available energy vectors, represents a huge challenge but also an immense business opportunity for the European Island.

Scope. ROBINSON aims to help decarbonise islands through developing an intelligent, flexible and modular Energy Management System (EMS), better integration of Renewable Energy Sources (RES), biomass and wastewater valorisation, industrial symbiosis, and the optimisation and validation of innovative technologies. The integrated ROBINSON energy system will ensure a reliable, cost-efficient and resilient energy supply contributing to the decarbonisation of the European islands by helping to decrease emissions. To support islands' decarbonisation, ROBINSON's EMS will integrate

newly developed and/or adapted technologies, such as a small gas turbine based Combined Heat and Power unit (CHP); Anaerobic Digester assisted by BioElectrochemical Systems (AD+BES) to enable the conversion of liquid waste into biomethane; a mobile innovative wind turbine; a gasifier to convert bio-waste; and hydrogen-related technologies (electrolyser and storage system).

The system will be demonstrated on the island of Eigerøy (Norway) and lab-scale level replication studies will be conducted for the island of Crete (Greece) and the Western Isles (Scotland). The user-friendliness and high modularity of the system ensure a great potential for replication on other islands, as well as in remote areas in Europe and beyond. The project will also encourage business opportunities for local communities and open up markets for the developed technologies.

Impact.

Replicability: ROBINSON will demonstrate that a smart and integrated energy system can be crucial in reducing fossil fuel consumption drastically by overcoming intermittency issues usually related to renewables. Replicability will be facilitated by the high flexibility and modularity of ROBINSON.

Socio-economics: In general, the ROBINSON system is expected to be cost-competitive compared to other variable RES and electrochemical storage (i.e. batteries). The lower cost will be achieved by a combination of storage and buffer capacity for the different energy vectors, but mostly by making use of hydrogen as a storage medium.

Environment: ROBINSON will help achieve a faster decarbonisation, enabled by reduction of fossil fuel consumption, increased efficiency, better RES integration, and waste valorisation.

Market Transformation: The combination of local energy generation and longer-term storage in the form of hydrogen, bio-methane and heat developed in ROBINSON will stabilize the local grid. ROBINSON will also allow for self-sustainable operation in cases of no grid connection (smoothing of the grid congestion issues and reverse energy flows).





LC-SC3-ES-4-2018-2020: Decarbonising energy systems of geographical Islands

[Back to projects' list](#)







VPP4ISLANDS

Virtual Power Plant for Interoperable and Smart is LANDS



VPP4Islands aims to facilitate the integration of renewable systems, accelerate the transition towards smart and green energy and help Islands to exploit energy efficiency potential and innovative storage approaches, foster the active participation of citizens and become self-sufficient in energy, while reducing costs, GHG emissions and reliance on heavy fuel oil to generate power, and creating new intelligent business, growth and local skilled jobs. To reach these goals, VPP4Islands project proposes disruptive solutions based on digital twin concept, Virtual energy storage systems (VESS) and Distributed Ledger technology (DLT) to revolutionize the existing VPP and build smart energy communities. Based on aggregation and smart management of distributed energy resources (DERs), VPP4Islands increases the flexibility and profitability of energy systems while providing novel services.

From Oct 2020	Project total cost	EU contribution	Website
To March 2024	7.2 M€	6.1 M€	www.vpp4islands.eu

Technologies and services deployed	Project partners' countries
 Technologies for consumers	
 Grid technologies	
 Large-scale storage technologies	
 Distributed storage technologies	
 Generation technologies	
 Market	
Demand response smart metering smart contract Virtual power plant Digital Twin Forecasting tools Batteries Virtual energy storage system Hydrogen Power to heat Wind Turbine PV Fuel cell generator Electricity Market Ancillary Services P2P marketplace	

Coordinator AMU (France)

Other partners:

- algoWatt (Italy)
- Blockchain 2050 BV (The Netherlands)
- Regenera Levante SL (Spain)
- Civiesco SRL (Italy)
- Ingenieria Y Diseno Estructural Avanzado SL (Spain)
- FTK Forschungsinstitut Fur Telekommunikation Und Kooperation EV (Germany)
- TROYA Genc Cevre Dernegi (Turkey)
- Consell Insular De Formentera (Spain)
- Bozcaada Belediye Baskanligi (Turkey)
- Schneider Electric Espana SA (Spain)
- Brunel University London (UK)
- Cardiff University (UK)
- Inavitas Enerji Anonim Sirketi (Turkey)
- RDIUP (France)
- Agencia Estatal Consejo Superior De Investigaciones Cientificas (Spain)
- Uludag Elektrik Dagitim Anonim Sirketi (Turkey)
- Bornholms Varme AS (Denmark)
- Comune di Grado (Italy)



Project Description

Context. As a result of the geographic insularity, the energy systems in Islands are characterized by high investment, installation and exploitation costs, low profitability, limited connection to the energy market, overdependence on fossil fuels, high greenhouse gas emissions level and poor electrical grid quality. Those barriers limit the improvement of the local energy infrastructure and slow down the economic development of the Islands.

Scope. VPP4Islands aims to develop a new concept for energy production, distribution and monitoring dedicated for islands. The new concept will promote RES use and revolutionize the existing small grids and Energy Communities (ECs) in Islands. The proposed flexible VPP will not be considered as a conventional power plant constituted of small distributed energy sources but as a flexible green power plant that can store surplus energy and modify their behaviour and architecture to support unpredictable growth and change of energy demand, climate and market, delivering stability to the grid. VPP4Islands will enhance the innovation capacity and competitiveness of the VPP in Europe based on demand-centred approaches to address the uncertainties and the weakness of the existing VPP.

Technical description and implementation.

VPP4Islands is mainly based on three concepts: Digital Twin, Distributed Ledger Technology (DLT) and Virtual Energy Storage System (VESS). The project aims to develop three tools: (1) VPP4I-Platform (2) VPP4I-Node (3) VPP4I-Box. The validation of the proposed solutions will be carried out in three Demo-sites: (1) FLEXIS in United Kingdom, (2) Gökçeada island in Turkey, and (3) Formentera island in Spain. FLEXIS demonstration area is a real-life pseudo island case study which will be exploited to assess and validate the economic benefits of the VESS. In Gökceada and Formentera islands, small RES and storage systems will be deployed in order to ensure the decarbonisation of the Island and increase the flexibility of the Grid. Both islands will become test zones for intelligent smart energy solutions, then new frame conditions for distributed energy resources can be tested too.

Impact. Replicability: During the project, the qualified VPP4Islands solutions will be replicated in 3 follower islands and a replication plan will be proposed.

Socio-economics: VPP4Islands will put citizens in the center of the energy systems and promote the building of sustainable energy communities. The VPP4I tools will increase the awareness of the energy transition and consumers will become more engaged and active. Grid upgrade and manipulation will contribute to create new jobs. Moreover, the dynamic incentive prices solution will help to increase the income and reduce the investment cost compared to conventional energy storage.

Environment: VPP4Islands will contribute to the energy savings thanks to load scheduling via Digital twin

optimization, Time of Use, eco-collective action (VPP platform), consumer engagement behaviour through dynamic incentive prices (VESS) and Peak Shaving through the increasing of mix storage systems penetration and controllable loads. Also, VPP4Islands is devoted to 100% renewable energy systems integration and participates considerably in the reduction of CO2 emissions.

Market Transformation: The proposed open technologies (DLT/ Digital Twin/ KB) will unlock the constrained energy market and catalyse the economic potential of the region. The proposed advanced forecasting tool, based on machine learning, will predict transparency and KB precisely when the electricity produced can be traded on the spot markets.

Policy: The Collaborative Knowledge Management (CKM) platform will allow to share best practices and increase users' knowledge and experience for energy management and trading, to develop a vision for applying the VPP4ISLANDS technologies, addressing business and societal demands, and to provide recommendations to policy and decision makers. Moreover, VPP4Islands' exploitation & dissemination efforts collectively aim to support the development of a white paper and policy guidelines.

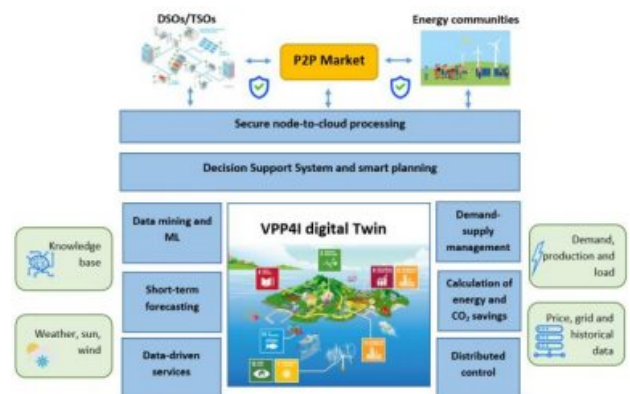

Architecture of the VPP4I Platform



OneNet

One Network for Europe



The world envisioned by OneNet will provide a seamless near real time integration of all the actors in the electricity network across countries with a view to create the conditions for a synergistic operation that optimizes the overall energy management while creating an open and fair market structure. This synergistic process is enabled by open IT architectures that guarantee continental level interoperability.

From 10/2020	Project total cost	EU contribution	Website
To 09/2023	28 M€	22 M€	https://onenet-project.eu/

Technologies and services deployed	Project partners' countries
 Technologies for consumers  Grid technologies  Large-scale storage technologies  Distributed storage technologies  Generation technologies  Market	<p>Demand Response</p> <p>Network management and control tools Micro-grid</p>  <p>Electricity Market Ancillary Services</p>

Coordinator

FRAUNHOFER GESELLSCHAFT ZUR FOERDERUNG DER ANGEWANDTEN FORSCHUNG E.V. (Germany)

Other partners:

- EDP DISTRIBUICAO ENERGIA SA (Portugal)
- RHEINISCH-WESTFAELISCHE TECHNISCHE HOCHSCHULE AACHEN (Germany)
- UBITECH ENERGY (Belgium)
- VLAAMSE INSTELLING VOOR TECHNOLOGISCH ONDERZOEK N.V. (Belgium)
- ENGINEERING - INGEGNERIA INFORMATICA SPA (Italy)
- EUROPEAN DYNAMICS LUXEMBOURG SA (Luxembourg)
- ENERIM OY (Finland)
- ETHNIKO KAI KAPODISTRIAKO PANEPISTIMIO ATHINON (Greece)
- ELES DOO SISTEMSKI OPERATER PRENSNEGA ELEKTROENERGETSKEGA OMREZJA (Slovenia)
- UNIVERSIDAD PONTIFICIA COMILLAS (Spain)
- EUROPEAN UNIVERSITY INSTITUTE (Italy)
- EUROPEAN DISTRIBUTION SYSTEM OPERATORS FOR SMART GRIDS (Belgium)
- EUROPEAN NETWORK OF TRANSMISSION SYSTEM OPERATORS FOR ELECTRICITY AISBL (Belgium)
- AKCJU SABIEDRIBA AUGSTSPRIEGUMA TIKLS (Latvia)
- ELEKTRILEVI OU (Estonia)
- ELENIA VERKKO OYJ (Finland)
- ELERING AS (Estonia)
- AB ENERGIJOS SKIRSTYMO OPERATORIUS (Lithuania)
- FINGRID OYJ (Finland)
- LITGRID AB (Lithuania)
- NORD POOL AS (Norway)
- OPEN UTILITY LTD (United Kingdom)
- AKCJU SABIEDRIBA SADALES TIKLS (Latvia)
- VATTENFALL AB (Sweden)
- CYBERNETICA AS (Estonia)
- DIACHEIRISTIS ELLINIKOU DIKTYOU DIANOMIS ELEKTRIKIS ENERGEIAS AE (Greece)
- INDEPENDENT POWER TRANSMISSION OPERATOR SA (Greece)
- MYTILINAIOS ANONIMI ETAIREIA (Greece)
- ENERGOINFO GROUP-SCINET DOO BEOGRAD-RAKOVICA (Serbia)
- UNIVERSITY OF CYPRUS (Cyprus)
- DIACHEIRISTIS SYSTIMATOS METAFORAS (Cyprus)
- RTE RESEAU DE TRANSPORT D'ELECTRICITE (France)
- ENEDIS (France)
- REN - REDE ELECTRICA NACIONAL SA (Portugal)
- INESC TEC - INSTITUTO DE ENGENHARIA DE SISTEMAS E COMPUTADORES, TECNOLOGIA E CIENCIA (Portugal)
- INSTITUTO PARA LA DIVERSIFICACION Y AHORRO DE LA ENERGIA (Spain)
- OMI-POLO ESPANOL SA (Spain)
- CENTRO DE INVESTIGACAO EM ENERGIA REN - STATE GRID SA (Portugal)
- CEPS AS (Czechia)
- ENERGA OPERATOR SA (Poland)
- POLSKIE SIECI ELEKTROENERGETYCZNE SPOLKA AKCYJNA (Poland)
- NARODOWE CENTRUM BADAN JADROWYCH (Poland)
- NKM ARAMHALOZATI KFT (Hungary)
- BUDAPESTI MUSZAKI ES GAZDASAGTUDOMANYI EGYETEM (Hungary)
- CEZ DISTRIBUCE AS (Czechia)
- CEZ ESCO AS (Czechia)
- ELEKTRO CELJE D.D. (Slovenia)
- EG.D AS (Czechia)
- E.ON Energie, a.s. (Czechia)
- ELEKTRO GORENJSKA PODJETJE ZA DISTRIBUCIJO ELEKTRICNE ENERGIJE DD (Slovenia)
- Elektroinstitut Milan Vidmar (Slovenia)
- ELEKTRO LJUBLJANA PODJETJE ZADISTRIBUCIJO ELEKTRICNE ENERGIJE D.D. (Slovenia)
- UNIVERZA V LJUBLJANI (Slovenia)
- GEN-I, TRGOVANJE IN PRODAJA ELEKTRICNE ENERGIJE, D.O.O. (Slovenia)
- MAVIR MAGYAR VILLAMOSENERGIA-IPARI ATVITELI RENDSZERIRANYITO ZARTKORUEN MUKODO RESZVENYTARSASAG (Hungary)
- MOBILITY ENERGY INNOVATIONS KFT (Hungary)
- SCHNEIDER ELECTRIC CZ SRO (Czechia)
- UNICORN SYSTEMS AS (Czechia)
- VYSOKE UCENI TECHNICKE V BRNE (Czechia)
- TRANSITION TECHNOLOGIES SA (Poland)
- E.ON DEL-DUNANTULI ARAMHALOZATI ZARTKORUEN MUKODO RESZVENYTARSASAG (Hungary)



- ARCHI ILEKTRISMOU KYPROU (Cyprus)
- CINTECH SOLUTIONS LTD (Cyprus)
- I-DE REDES ELECTRICAS INTELIGENTE SA (Spain)
- UFD DISTRIBUCION ELECTRICIDAD SA (Spain)
- EPRI EUROPE DAC (Ireland)
- RESCOOP EU ASBL (Belgium)
- ENERGY EFFICIENCY IN INDUSTRIAL PROCESSES ASBL (Belgium)
- ENERCOUTIM - ASSOCIACAO EMPRESARIAL DE ENERGIA SOLAR DE ALCOUTIM (Portugal)



Project Description

Context. A new generation of grid services is in the making to enhance the power system. Demand response, storage and distributed generation of energy are key for creating fair, transparent and open conditions for the consumer. However, realizing this vision requires the development of new products and services and the creation of a new IT architecture. The OneNet project is taking on this ambitious endeavour. It proposes innovative mechanisms of platform federation that are key technical enablers, made possible through a strong consortium that includes an impressive list of grid operators as well as key IT actors, leading research institutions and two of the most relevant grid operator associations.

Scope. The OneNet framework aims to create a fully replicable and scalable architecture that enables the whole European electrical system to operate as a single system in which a variety of markets allows the universal participation of stakeholders regardless of their physical location, at every level from small consumer to large producers.

OneNet will provide a framework of data management supporting flexibility markets and monitoring and optimization of the overall European electrical infrastructure, expressed as:

- A clear and open architecture that will enable any player to participate at innovative market structures,
- A smooth integration of the grid and market operation for TSO and DSO in the innovative market structure,
- New customer-centric business models to support next generation service-based markets.

Technical description and implementation. OneNet will develop an open and flexible architecture to transform the actual European electricity system, which is often managed in a fragmented country- or area-level way, into a pan-European smarter and more efficient one, where market and network technical operations are reciprocally coordinated closer to real time i) among them, ii) across different countries iii) while maximizing the consumer capabilities to participate in an open market structure.

OneNet will follow a 7-Step process

1. Define new and standardized products and services starting from project experience
2. Identify appropriate market structures in support of the defined products and services
3. Design open IT architecture supported by scalable data management enabling market structures
4. Implement architecture in a reference version to be used as basis for a European deployment
5. Verify in a set of large field tests the concepts and solutions proposed by OneNet
6. Create European level consensus thanks to GRIFOn open forum with all the key stakeholders
7. Push the result of OneNet in the standardization process for a significant market uptake

Impact. Replicability: OneNet will demonstrate its solution in four large multinational demonstration clusters, so far unreached in size and with an TRL of 8 and higher.

Socio-economics: The OneNet vision will unlock a new service-oriented market, making the Energy system of Europe the most advanced and open in the world.

Environment: A harmonized pan-European energy market will foster innovation in the energy sector and enable the energy transition.

Market Transformation: Transforming the fragmented European energy markets into one interoperable European energy market – “One Network for Europe”. This market will be characterized by standardized market products and energy services.

Policy: Policy and governance will become aware of the opportunities offered by the flexible market proposed by OneNet, which will reach an unseen level of Europe-wide consensus, thanks to GRIFOn.





H2020 call: LC-SC3-ES-13-2020 - Integrated local energy systems (Energy islands):
International cooperation with India

[Back to projects' list](#)

RE-EMPOWERED







Renewable Energy EMPOWERing European and INdian communities



RE-EMPOWERED
Renewable Energy EMPOWERing
European & INdian Communities

The main goal of RE-EMPOWERED is to develop and demonstrate solutions for energy transition of island and weakly connected energy systems, based on Microgrids exploiting multiple energy vectors. The benefits will be demonstrated leading to an increased share of renewable generation and higher energy efficiency of the wider local energy system. RE-EMPOWERED will develop a complete set of solutions for local energy systems that will be demonstrated in four pilot sites, two European and two Indian, complementary in terms of size, organisational and technical maturity

From 1/07/2021 To 31/12/2024	Project total cost	EU contribution	Website
	5.005 M€	2.987 M€	https://reempowered-h2020.com/

Technologies and services deployed		Project partners' countries
 Technologies for consumers	for storage	
 Grid technologies		
 Distributed technologies		
 Generation technologies		
 Market		
	Demand response Smart metering Smartphone application Network management and control tools Micro-grid Power electronic converters Batteries Electric Vehicles Thermal energy storage Wind turbine Photovoltaic Biogas Micro-generation Biomass Ancillary services	

Coordinator: ICCS - NTUA (Greece - European Coordinator)
Indian Institute of Technology Kharagpur (India - Indian Coordinator)

Other partners:

- Imperial College London (United Kingdom)
- Danmarks Tekniske Universitet (Denmark)
- Bornholms Varme As (Denmark)
- PROTASIS SA (Greece)
- Deloitte Advisory, S.L. (Spain)
- DAFNI (Greece)
- Indian Institute of Technology Bhubaneswar (India)
- Visvesvaraya National Institute of Technology (India)
- CSIR - Central Mechanical Engineering Research Institute (India)
- Indian Institute of Science (India)
- Indian Institute of Technology Delhi (India)
- Lab Concern India (India)

Project Description

Context



The rapid penetration of renewable energy sources to the electricity grid is a key factor for achieving the decarbonization goals of the EU. Local energy systems can support RES integration, using optimization techniques and exploiting synergies with different energy vectors, such as heating/ cooling, transport etc. Advanced system architectures, operation and planning, power electronic interfaces, digitalization and ICT, energy storage in various forms (EVs, batteries, heating) can contribute in addressing the RES challenges.

The role of citizens' participation and engagement in the decarbonization of local energy systems is crucial. In particular, energy communities empower citizens in order to increase local RES integration. In that direction, integrated local energy systems offer the possibility of attracting investments by adopting innovative business models.

Both Europe and India are trying to achieve ambitious environmental protection goals, while India is striving to provide electricity to all its population.

SCOPE. The main goal of RE-EMPOWERED is to develop and demonstrate solutions for energy transition of local energy systems based on multi-energy Microgrids, interconnecting multiple energy vectors. This will be demonstrated by an increased share of renewable generation and higher energy efficiency of the wider local energy system.

RE-EMPOWERED develops a complete set of solutions for local energy systems that will be demonstrated in four pilot sites, two European and two Indian, complementary in terms of size, organisational and technical maturity. Demo-sites include Bornholm Island in Denmark, Kythnos island in Greece and Keonjhar and Ghoramara island in India. The solutions range from planning tools for designing or upgrading energy systems, to control and optimization tools for the management of microgrids, interoperable platforms for the integration of the available energy

carriers, the digitization of the system and advanced hardware infrastructure for upgrading the local systems.

TECHNICAL DESCRIPTION AND IMPLEMENTATION.

The results of RE-EMPOWERED comprise of ten ecoTools that form the ecoToolset and include all the hardware and software solutions developed in the project:

- ecoEMS: Energy management system (EMS) for isolated and weakly interconnected energy systems by increasing the share of RES.
- ecoMicrogrid: Energy Management System for microgrids/off-grid systems
- ecoDR: Development of advanced metering infrastructure (AMI) with inbuilt load controller and protection functionalities.
- ecoConverter: Power electronic converters for dc/ac microgrids
- ecoVehicle: Electric vehicle charger
- ecoPlanning: Energy planning tool

- ecoCommunity: Citizen engagement digital platform
- ecoResilience: Cyclone Resilient infrastructure for wind turbines and PV
- ecoMonitor: Water/air quality monitoring
- ecoPlatform: Cloud-based interoperable platform

IMPACT.

Replicability: The project aims to benchmark technical solutions and business models that can be replicated in many local regions and that are acceptable by local citizens

Socio-economics: The project will enhance the involvement of local energy consumers and producers, preferably by creating energy communities in the development and the operation of local energy systems and test new business models

Environment: One of the main goals of the project is to validate approaches, strategies and tools to operate an integrated local energy system across energy vectors so that it is able to integrate higher shares of renewables and improve energy efficiency.





H2020 -LC-SC3-ES-13-2020 - Integrated local energy systems (Energy islands): International cooperation with India

[Back to projects' list](#)

SUSTENANCE





SUSTainable ENergy system for Achieving Novel Carbon neutral Energy communities



The overall objective of the project is to set up sustainable energy-systems for achieving novel carbon neutral energy communities. The project focuses on development of smart technological concepts, enabling a green transition of the energy systems with higher share of local renewable energy and more efficient integrated energy solutions for electric, heat, water, waste as well as transport infrastructures using smart control, balancing of grid, storage solutions and active load control.

From 01.07.2021 To 31.12.2024	Project total cost	EU contribution	Website
	6.27 M€	3.49 M€	https://h2020sustenance.eu

Technologies and services deployed

	Technologies for consumers	Heat pumps- PV-solar-thermal salt heat storage batteries EV-charging.
	Grid technologies	Energy flexibility and networks.
	Large-scale storage technologies	
	Distributed storage technologies	Batteries including EV batteries Salt heat storages.
	Generation technologies	PV, wind and biogas.

Project partners' countries



Coordinator: Aalborg University (AAU) Denmark

Other partners:

- Skanderborg Kommune (SKM), Denmark
- Aura Energi (AER), Denmark
- Neogrid (NGD), Denmark
- Bjerregaard Consulting (BJC), Denmark
- University of Twente (UTE), The Netherlands
- Saxion University of Applied Science (SAX), The Netherlands
- The Inst. of Fluid-Flow Machinery of the Polish Academy of Sciences (IMP), Poland
- Energa-Operator SA (EOR), Poland
- Stay-ON Energy Management (SON), Poland
- KEZO Foundation at Polish Academy of Science Research Centre (KEZ), Poland
- Indian Institute of Technology, Bombay (IITB), India
- Indian Institute of Science, Bangalore (IISc), India
- Indian Institute of Technology, Kharagpur (IITKGP), India
- Indian Institute of Technology, Delhi (IITDE), India
- National Institute of Technology, Tiruchirappalli (NITT), India
- National Institute of Technology, Silchar (NITS), India
- Visvesvaraya National Institute of Technology, Nagpur (VNIT), India
- Indian Institute of Technology, Bombay (IITB)
- Indian Institute of Science, Bangalore (IISc)
- Indian Institute of Technology, Kharagpur (IITKGP)
- Indian Institute of Technology, Varanasi (IITBHU)
- National Institute of Technology, Tiruchirappalli (NITT)
- National Institute of Technology, Silchar (NITS)
- Visvesvaraya National Institute of Technology, Nagpur (VNIT)
- Motilal Nehru National Institute of Technology, Allahabad (MMNIT)
- Innovation Laboratory Energy, Mumbai (ILABE)
- Gram Oorja, Mumbai (GOR)
- Urjalinks (URJA)
- Motilal Nehru National Institute of Technology, Allahabad (MMNIT), India
- Gram Oorja Private Solutions Ltd. (GOR), India



Project Description

Context

The demonstration activities in SUSTENANCE project are targeted in four countries, Denmark, India, Netherlands and Poland that have varying local energy resources, different socio-economic and institutional setups, topographical characteristics, energy policies and market conditions. Each of the considered neighborhoods has specific energy challenges and options which are representative to several other communities in Europe and India, and that offer excellent platforms for maximum impact for demonstration and development of project solutions and their further replication.

Scope.

The key focus of the SUSTENANCE project is to build carbon-neutral energy communities by establishing local, sustainable and efficient integrated energy systems. The main objective of SUSTENANCE is:

- to develop and demonstrate smart techno-socio-economic and ecofriendly solutions and tools for effecting multi-energy systems and collective action in communities,
- to maximize the local use of renewable energy and enabling energy efficiency,
- to enhance the quality of life for the citizens in those communities.

The demonstrations activities in the project are conducted in different European and Indian neighborhoods, facilitating mutual learning, knowledge transfer, and co-innovation for enhancing the value of innovative solutions thereby developed and its replicability in other communities within these countries and beyond.

Technical description and implementation.

To design and develop a holistic system framework for integrating various energy vectors and networks in local energy communities to realize efficient and reliable use of energy and maximizing self-consumption from renewable energy.

To select and demonstrate local demand response (DR) methods in the different demonstrators to utilize energy flexibility from electricity consumption units in different energy sectors and from energy storages with active participation from the citizens for realizing cheaper energy for the community, counteracting the variable nature of renewables and realizing smart operation of energy networks.

To develop and test technical and commercial aggregation methods for economic scheduling and cost-effective operation of flexible units and distributed energy resources.

To develop and demonstrate smart distributed control schemes to effect community based multi energy vector interaction and utilization to facilitate demand side management (DSM), smarten the electricity networks with the use of ICT technologies, advanced metering infrastructure and advanced power electronic controls.

To develop and test energy forecasting and smart energy management systems (EMS) for community based multi-micro grid and multi-energy systems (buildings, neighborhood, residential blocks/clusters) for effecting optimal energy balancing, energy block-chain and economic operation of integrated energy systems.

Impact. Replicability:

To identify and evaluate the impact of the social innovations on active participation and engagement in the local community energy systems during and after the project period.

To elaborate on new and alternative organizational configurations for more autarkic citizen-centered local integrated energy systems.

To develop benchmark models and tools for the replication of technical and social innovations in other local communities and regions in Europe and India.

Socio-economics: To develop a comprehensive framework of the socio-economic, governance and regulatory conditions and criteria for an organizational configuration that aligns with the technical requirements of a more autarkic local integrated citizen-centered energy system.

To analyze the social acceptability of demand control, flexibility options and renewable energy choices within a more autarkic local energy project for citizens, with a particular focus on the organizational configuration and how such a system can be governed.

Environment: The project focus on integration of RES in Europe as well as in India thereby addressing CO2 reduction since fossil fuels (gas, oil, wood) are replaced with wind and solar energy. At the same time the project also focusses on energy efficiency targets, where the total energy efficiency are increased due to the integrated energy systems and replacement of fuel-based transportation with e-transportation in the form of EVs and e-rickshaws.

Market Transformation: To design a suitable organizational configuration, in particular a business model and citizen's collective action structure, and support tools to create such an organizational configuration for technical and organizational needs of each demonstrator. Develop criteria for attractive and viable business model and a strengthened local economy in more autarkic citizen-centered local integrated energy systems.

Policy: Awareness of energy consumption and what can be done to provide flexibility and, in this way ensuring stable and reliable infrastructure and create possibilities for cheaper energy for citizens. Be able to form cooperatives ensuring local energy production and sustainable developments. Enabling green transition in local regions by ensuring awareness and business models for the future smart energy systems, integration of RES and appropriate storage facilities. Make active costumers participate in markets via aggregators. Ensure better infrastructures at the countryside, making better possibilities for local small industry and for citizens to stay at the countryside.



HORIZON-CL5-2021-D3-01-01: Establish the grounds for a common European energy data space

[Back to projects' list](#)

DATACELLAR

Data Hub for the Creation of Energy communities at Local Level and to Advance Research on them



DATA CELLAR aims to create a federated energy dataspace that will support the creation, development, and management of local energy communities in the EU. The data space population will be facilitated via an innovative rewarded private metering approach, with a focus on an easy onboarding and interaction, guaranteeing a smooth integration with other EU energy data spaces, providing to LEC stakeholders services and tools for developing their activities.

From 2022	Project total cost	EU contribution	Website
To 30/11/2025	9 M€	9 M€	https://datacellarproject.eu/

Technologies and services deployed		Project partners' countries
Technologies for consumers	Demand Response Smart Appliance Smart Metering Micro-grid	
Grid technologies	Batteries Electric Vehicles	
Large-scale storage technologies		
Distributed storage technologies	Thermal energy storage Wind turbine PV	
Generation technologies	Microgeneration	
Market	Electricity Market Ancillary Services	

Coordinator Rina Consulting SPA

Other partners:

- CERTH (Greece)
- CIRCE (Spain)
- UBITECH(Belgium)
- NODES(Norway)
- QUE (Greece)
- POLITO (Italy)
- AEM (Switzerland)
- LINKS (Italy)
- CTIC (Spain)
- EDF (France)
- EUNICE(Germany)
- TRI (Ireland)
- TRI (UK)
- RUG(Netherlands)
- ZABALA(Belgium)
- ZABALA INN (Spain)
- EPL (Cyprus)
- FOSS (Cyprus)



Project Description

Context.

A greener energy system is crucial for the future prosperity and liveability of European citizens. This requirement is at the heart of the DATA CELLAR approach where Local Energy Communities (LECs) have been recognised by the European Commission as a pivotal measure to play a key role in driving the EU's energy transition. At the same time, the digitisation of the EU energy system and the proper exchange of data between energy actors appear crucial to foster the exchange of best practices and the creation of a knowledge community to tackle one of our society's most pressing global crises: climate change.

Scope Local energy communities (LECs) can play an important role in the transition towards a sustainable and clean energy system infrastructure. They are considered pivotal in the digitalisation of the EU energy system, and the sharing of data among the energy players will promote practice sharing and knowledge to tackle climate change. The EU-funded DATA CELLAR project will create an inclusive energy data space that makes interaction easy. It will also support the creation, development and management of LECs in the EU. This data space will guarantee smooth integration with other EU energy data spaces. The project will implement a collaborative platform to supply interoperable, modular and secure access to data sets, decision support tools and AI models.

Impact. Replicability: The data gathering/sharing approach of Data Cellar, the proposed services as well as data shared by Data Cellar's validation cases within the project will be validated among Data Cellar's validation cases as well as validation cases from other sister projects. The adapted solutions once validated will form the basis for future operation and expansion of Data Cellar. For this reason, the developed systems will be documented with all well-designed common ontology needs and interoperable operational modes agreed to facilitate replicability and scalability. This will facilitate an architectural integration with the other dataspace both during and beyond the project itself.

Socio-economics: The DSS tool, to be developed in task 5.3, has an important socio-economic component, as its objective is to support developers of energy communities in their design and grid integration, maximising their economic profitability and consumption of locally generated renewable energy while electrifying thermal and transport loads. Thus, the economic and social profitability of the equipment to be sized and located using the DSS is a fundamental boundary condition.

Environment: In relation to the environmental field, the DSS tool to be developed in the Data Cellar Project aims to facilitate the implementation and a wide spread of renewable energies and electrification of loads in energy communities through the correct sizing and location of these installations (whether common or of an individual member) and through the optimal location, sizing and operation of distributed resources that facilitate their implementation and management and reduce their impact

on the grid. These latter elements can be owned by the distribution grid operators or by the energy community itself: D-STATCOM, ESS, hydrogen storage, etc... For the development of this tool, the available information will be analysed and, based on this, the appropriate optimisation algorithms and methodologies will be chosen for the sizing of the DERS, thus reducing the overall environmental impact of the energy community.

Market Transformation: Data Cellar aims to design a decentralised and open marketplace for energy datasets and AI models. The system will be able to guarantee a proof-of-origin for data and AI models, leveraging the concept of smart contracts, guaranteeing an on-chain identity management, authentication, and verification service. In addition, a token economy is expected to be put in place, which will ensure a full transparency on the transactions when selling, renting, and sharing energy data. The integration of this marketplace will consider the libraries, Digital Twins and DSS developed, and the cloud platform where data streams from other dataspace will be stored and retrieved. All this will lead to the creation of new business models tackling users' and investors' needs, with the ultimate goal of attracting further data providers, which will guarantee the continuity and exploitation of the marketplace after project timeline.





HORIZON-CL5-2021-D3-01-01: Establish the grounds for a common European energy data space

[Back to projects' list](#)







EDDIE

European Distributed Data Infrastructure for Energy



EDDIE aims at lowering data integration costs drastically to tackle the existing economic problem of the limited energy data interoperability. EDDIE's vision is to make it cheap and easy for data-based energy services to operate on a common European energy data space. The consortium of EDDIE includes leading experts on data-sharing, smart grids, legislation, and IT development, who will contribute with connecting and opening their national environments.

From 2023	Project total cost	EU contribution	Website
To 31/12/2025	8.7 M€	7.9 M€	https://eddie.energy/

Technologies and services deployed		Project partners' countries
	Technologies for consumers	
	Grid technologies	
	Large-scale storage technologies	
	Distributed storage technologies	
	Generation technologies	
	Market	
	<ul style="list-style-type: none"> Consent management Access to energy data Access to real-time data Real-time data aggregation Power to gas Hydro Storage Batteries Electric Vehicles Wind turbine PV Electricity Market Ancillary Services 	

Coordinator	AIT AUSTRIAN INSTITUTE OF TECHNOLOGY GMBH (Austria)
--------------------	--

Other partners:

- COPENHAGEN BUSINESS SCHOOL (Denmark)
- EUROPEAN UNIVERSITY INSTITUTE (Italy)
- UNIVERSITAT WIEN (Austria)
- FH OO FORSCHUNGS & ENTWICKLUNGS GMBH (Austria)
- THE LISBON COUNCIL FOR ECONOMIC COMPETITIVENESS ASBL (Belgium)
- PONTON GMBH (Germany)
- ASOCIACION DE EMPRESAS DE ENERGIA ELECTRICA (Spain)
- DIMOSIA EPICHEIRISI DIKTYON DIANOMIS AERIOU MONOPROSOPI ANONYMI ETAIREIA (Greece)
- EDA ENERGIEWIRTSCHAFTLICHER DATENAUSTAUSCH GMBH (Austria)
- SUDTIROLER ENERGIE VERBAND GENOSSENSCHAFT (Italy)
- FLEXIDAO S.E.S., SOCIEDAD LIMITADA (Spain)
- DIGITAL4GRIDS (France)
- EUROPEAN ASSOCIATION FOR THE STREAMLINING OF ENERGY EXCHANGE GAS (France)
- ENTARC.EU (Austria)



Project Description

Context.

Today, more and more energy data-based services emerge within and beyond the energy sector, enabled by European legislation. In the energy sector, Directive (EU) 2019/944 of the Clean Energy for all Europeans Package [1] recently established the rights to access energy-related metering, production and consumption data for customers and eligible parties (EP) of their choice. Services of this kind empower customers, can consult energy buyers based on their consumption patterns or contribute to efficient energy management, amongst others. However, the main barrier today is that there is no

Impact.

EDDIE Framework will integrate with these practices directly, adapting to the national specificities.

In-house Infrastructure: Describes the situation managed by AIIDA, which acts as a separate installable component. AIIDA will have different deployment configurations to account for different platforms (home automation systems, SoCs, etc.) and plugin modules capable of providing connectivity for meter (operating) modellers scale, uniform, and easy access to energy data across European Member States, which is a severe handicap for new services, e.g., as web-based or mobile applications, to emerge, raise the energy awareness of citizens and foster economic growth on a European level. Currently, players also act on national data-sharing infrastructure and practices, which limits their interoperability and growth perspective. These constraints of national data-sharing infrastructure have an industrial, economic, and social dimension on a European level and beyond.

Scope

The EDDIE project will focus on a dependable, scalable and extensible framework that provides access to energy data. This framework will be installable in the domain of eligible parties with the need of access to energy data on a customer consent basis. There will be no need for additional centralized intermediaries.

In addition, the EDDIE project will provide an Administrative Interface for Inhouse Data Access (AIIDA), which is easily integrable in domestic software systems like smart home solutions or edge devices, making use of existing or additional hardware to be easily deployed in consumer houses. This will provide customers with a new solution to make available data streams from the standardized near real-time interface on the smart meter (priority) and a variety of in-house sensors.

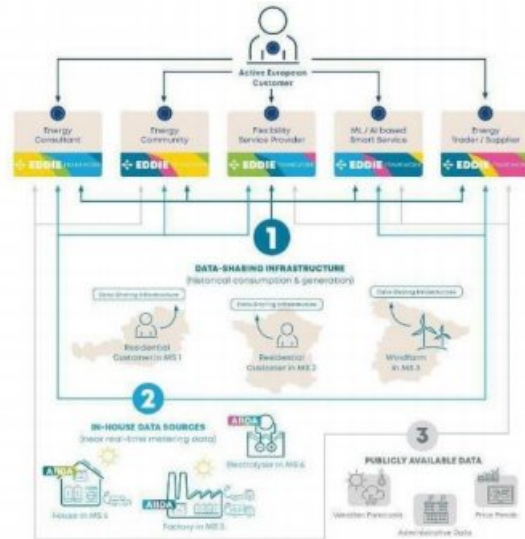

Technical description and implementation

The Figure below shows the components that will be considered in the context of EDDIE. The white boxes in this figure are:

EP's Application Landscape: Shows the infrastructure that is under the control of the EP.

EDDIE Framework: This is downloaded through containerized deployment or other installation means.

The Regional Data-sharing Infrastructure: Describes the practices relevant for a region. The

Accessibility: EDDIE is expected to establish an outstanding coverage of more than 70% of European metering points as well as additional others.

Replicability: The software that is expected to be delivered in the context of EDDIE will be open source, i.e., not bound by any licensing constraints, thus allowing the EPs to utilize and further extend it.

Socio-economics: Due to the availability of data aggregated by the EDDIE framework, start-up companies that provide novel data-driven services may emerge.

Education: Academic consortium members will teach and the use of the EDDIE Framework, AIIDA and integration options in their lectures.

Market Transformation: Due to the EDDIE framework, European users will have the opportunity to share their data with EP from any member state. This can boost the competition in a European level.

Policy: The availability of energy data enabled by EDDIE will support the policy goals of the European Commission regarding digitization and sustainability.



HORIZON-CL5-2021-D3-01-01: Establish the grounds for a common European energy data space

[Back to projects' list](#)







ENERSHARE

European common Energy dataSpace framework enabling data sharing-driven Across- and beyond- energy services



The aim is to develop and demonstrate a European Common Energy Data Space which will deploy an 'intra-energy' and 'cross-sector' interoperable and trusted Energy Data Ecosystem where private consumers, business (energy and non-energy) stakeholders and regulated operators will be able to access, share and reuse, based upon voluntary agreements (or legal obligations where such obligations are in force): (i) Large sources of currently fragmented and dispersed data; (ii) Data-driven cross-value chain (energy and non-energy) services and Digital Twins for various purposes.

From 01/07/2022	Project total cost	EU contribution	Website
To 30/06/2025	9.538 M€	7.999 M€	https://enershare.eu/

Technologies and services deployed	Project partners' countries
 Technologies for consumers  Grid technologies  Large-scale storage technologies  Distributed storage technologies  Generation technologies  Market	Demand response Smart metering Smart Appliances Network management, monitoring and control tools Microgrid Hydrogen-based Power2Gas Batteries EVs PV Cross-value chain blockchain marketplace



Coordinator ENGINEERING INGEGNERIA INFORMATICA SPA (ITALY)

Other partners:

- RHEINISCH-WESTFAELISCHE TECHNISCHE HOCHSCHULE AACHEN (Germany)
- EUROPEAN DYNAMICS SA (Luxembourg)
- FRAUNHOFER GESELLSCHAFT ZUR FORDERUNG DER ANGEWANDTEN FORSCHUNG EV (Germany)
- FUNDACION TECNALIA RESEARCH & INNOVATION (Spain)
- INESC TEC - INSTITUTO DE ENGENHARIA DE SISTEMAS E COMPUTADORES, TECNOLOGIA E CIENCIA (Portugal)
- SMART ENERGY LAB - ASSOCIATION (Portugal) – Third party
- NEDERLANDSE ORGANISATIE VOOR TOEGEPAST NATUURWETENSCHAPPELIJK ONDERZOEK TNO (The Netherlands)
- ETHNICON METSOVION POLYTECHNION (Greece)
- TRIALOG (France)
- COMSENSUS, KOMUNIKACIJE IN SENZORIKA (Slovenia)
- ENVIRODUAL, TRAJNOSTNO OKOLJSKO IN ENERGETSKO UPRAVLJANJE, RAZISKAVE IN IZOBRAZEVANJE, D.O.O. (Slovenia)
- SMART INNOVATION NORWAY AS (Norway)
- INTERNATIONAL DATA SPACES EV (Germany)
- ENVIRODUAL, TRAJNOSTNO OKOLJSKO IN ENERGETSKO UPRAVLJANJE, RAZISKAVE IN IZOBRAZEVANJE, D.O.O. (Slovenia)
- CENTRO DE INVESTIGACAO EM ENERGIA REN - STATE GRID SA (Portugal)
- ASM TERNI SPA (Italy)
- ELES DOO SISTEMSKI OPERATER PRENOSNEGA ELEKTROENERGETSKEGA OMREZJA (Slovenia)
- ENGIE (France)
- DEPA COMMERCIAL SA (Greece)
- CLUSTER DE ENERGIA (Spain)
- EMOTION SRL (Italy)
- HINE RENEWABLES SL (Spain)
- ELECTRICITE DE FRANCE (France)
- KOMUNALNO PODJETJE VELENJE DOO (Slovenia)
- FORTUM OYJ (Finland)
- NOKIA OYJ (Finland)
- ELEKTRO CELJE D.D. (Slovenia)



- FIWARE FOUNDATION EV (Germany)

- ELEKTRO LJUBLJANA PODJETJE ZADISTRIBUCIJO ELEKTRICNE ENERGIJE D.D. (Slovenia)
- VIDES INVESTICIJU FONDS SIA (Latvia)

Project Description

Context. Whereas the number of data transactions is growing exponentially along the energy sector, data stakeholders – consumers, businesses, network operators, institutions – have an obvious growing need for having more control of their data. An energy data sharing framework becomes necessary which should give stakeholders full control of data sharing at the source (e.g. registers of grid operators, suppliers or IoT players) and focusing on answering the fundamental question ‘Who can access which data and for what purpose?’. However data sharing in the energy sector is lagging behind, mainly due to lack of trust, privacy breaches risk and business models immaturity.

Scope The resulting Reference Implementation of a European Energy Data Space will be demonstrated along 7 pilots and 11 intra-electricity, intra-energy and beyond energy use cases to enable a consumer-centric effective and fully decarbonized electricity-centered energy system

Technical description and implementation.

ENERSHARE will a) deliver a Reference Architecture for a European Energy Data Space, which hybridizes SGAM with IDSA and GAIA-X architectures, by bringing data value chain perspective into the energy one b) evolve interoperability, trust, data value and governance building blocks to TRL 6-7 IDSA-compliant ones, adapt them to energy sector, and deploy: 1) across-energy and cross-sector data enhancement technology enablers and standardizable interfaces and open APIs by leveraging on open Standards (e.g. ETSI Context Broker) and ontologies (e.g. SAREF 2) trust-related connectors, to ensure privacy, confidentiality, cybersecurity-preserving trust, sovereignty and full control of data 3) Blockchain/Smart contract-enriched marketplace for data versus energy assets/services coordination, sharing, exchange, and beyond financial compensation 4) cross-value chain value-added services and Digital Twins, by leveraging on privacy-preserving federated learning c) integrate and deploy them within a Reference Implementation of a European Energy Data Space, which will be demonstrated along 7 pilots and 11 intra-electricity, intra-energy and beyond energy use cases d) co-design SSH-based consumer-centric business models for energy data sharing enabling data beyond-financial value creation and spreading along value chain d) prepare the ground for the European Energy Data Space setup, through alignment with EU-level relevant initiatives (GAIA-X, IDSA, BDVA, ETIP SNET, BRIDGE), contributing to Data Space standardization and boosting a level playing field for data sharing.

Replicability: the extensive geographical coverage of the 7 pilot sites allows to support the large-scale EU-wide boosting and market take-up of services and solutions in different socio-economical contexts, while at the same time enabling to maximize the impact of ENERSHARE outcomes across Europe.

Socio-economics: The ENERSHARE project introduces significant mechanisms and underlying enabling technologies, such as the blockchain-based marketplace for tokenized heterogeneous assets (energy, data) exchange and compensation to realize a participatory data-driven energy systems, where energy consumers (B2C and B2B), will overcome their reluctance in data sharing thanks to the increased trust and data sovereignty and thanks to the option of exchanging energy consumption data with energy and non-energy services

Environment: The technological solutions proposed by ENERSHARE will result in a significant positive benefit on the environmental footprint of the overall energy system as a whole, consisting of electricity, heat, gas networks, hence contributing to the progressive decarbonisation of the overall energy systems.

Market Transformation: To contribute to open up and redesign the energy value chain while bringing center stage new roles pertaining to the Data Value Chain (es Data provider, Data Aggregator, Data consumers, Data Cooperative, etc...). This will facilitate the deployment of new data sharing building blocks and new cross-commodity and cross-value chain data-driven services, which will result in a more efficient consumer-centric energy system

Policy: The vision enabled by ENERSHARE as well as the technologies which will be deployed will allow to draw blueprints and guidelines to support regulatory bodies, EC- and national- level policy makers to fully implement the Digitization of Energy Action Plan (DoAEP), and and the EC Data Strategy towards a Single European Market, hence contributing to move towards a consumer-centric greener decentralized energy systems.

Impact



HORIZON-CLS-2021-D3-01-01: Establish the grounds for a common European energy data space

[Back to projects' list](#)







OMEGA-X

Orchestrating an interoperable sovereign federated Multi-vector Energy data space built on open standards and ready for GAia-X



The aim of OMEGA-X is to implement a data space (based on European common standards), including federated infrastructure, data marketplace and service marketplace, involving data sharing between different stakeholders and demonstrating its value for real and concrete Energy use cases and needs, while guaranteeing scalability and interoperability with other data space initiatives, not just for energy but also cross-sector.

From 2022	Project total cost	EU contribution	Website
To 30/04/2025	10.2 M€	8 M€	https://omega-x.eu/

Technologies and services deployed		Project partners' countries
	Technologies for consumers	
	Grid technologies	
	Large-scale storage technologies	
	Distributed storage technologies	
	Generation technologies	

Demand response

Network management, monitoring and control tools

Batteries, EVs...

PV

Coordinator Atos (Spain)

Other partners:

- Atos Worldgrid (FR)
- Tecalia (SP)
- EDF (FR)
- ENGIE (FR)
- EDP (PT)
- Estabanell (SP)
- Elia (BE)
- Polytechnic University of Catalunya (SP)
- IDSA (GE)
- Intracom (GR)
- Odit-e (FR)
- Open & Agile Smart Cities (BE)
- RINA Consulting (IT)
- Municipality of Maia (PT)
- Aarhus University (DK)
- IMT Transfert (FR)
- Maiêutica – Cooperativa de Ensino Superior (PT)
- Institut Mihajlo Pupin (SRB)
- SENER (SP)
- Estabanell y Pahisa MERCATOR (SP)
- Astea (IT)
- Universidade Catolica Portuguesa (PT)
- GIREVE (FR)
- Energy Web (GE)
- LichtBlick (GE)



Project Description

Context: Large amounts of valuable data are available in energy systems but are often underused. There is no single data platform, for example, connecting data from the generation, transmission, distribution and consumption domains in Europe’s electricity sector or across the various energy vectors – electricity, gas, heat, etc. The barriers also imply the lack of proper mechanisms and policies that ensure secure, sovereign and fair data sharing.

Scope. Relying on European common standards, the EU-funded OMEGA-X project aims to implement an energy data space. This will include federated infrastructure, data marketplace and service marketplace, involving data sharing between different stakeholders and demonstrating its value for concrete energy use cases while guaranteeing scalability and interoperability with other data space initiatives.

Technical description and implementation: The proposed concept and architecture heavily rely on the approaches adopted by both IDSA and Gaia-X, as major EU references regarding Data Spaces, including also additional references such as FIWARE, BDVA/DAIRO and SGAM (purely on the energy sector). IDSA approach focuses on data sovereignty, as the ability of a given actor (corporate or person) to act as self-determined for its own data. Therefore, the primary goal of its reference architecture relies on deriving appropriate requirements for a sound, secured and trusted data trading.

Impact: OMEGA-X will develop an Energy Data Space that enables multiple actors sharing data and services while ensuring privacy, security and sovereignty. This will specifically address the current problem of low availability of data for innovative uses in the energy sector and beyond. OMEGA-X will collaborate with stakeholders to identify where energy-based service improvements and innovation are required, and how OMEGA-X could potentially be used and adopted to address these needs:

Replicability:
The project has interoperability as a core objective. This means adopting standard approaches for architecture and data exchange, while also aligning with the main references as per Data Spaces, such as Gaia-X and IDSA, among others. The ultimate goal consists on building a Data Space which, on the one hand, will be able to discover and interact with other Data Spaces and, on the other hand, allow any external participant to federate and use the ecosystem. Therefore, full replicability should be guaranteed, as well as scalability.

Socio-economics:
The availability of data will empower new participants and market roles such as aggregators and local energy community managers. This will facilitate the large-scale penetration of renewables in the local grid without significant investments in grid infrastructure and will also create an opportunity for new business models to emerge.
Environment:
OMEGA-X will put a prominent focus on developing and promoting inclusive and collaborative behaviours, which will lead to a multitude of societal and economic benefits, such as, an increase in energy autonomy and a reduction in CO2 emissions.

Policy:
A particular group will be established so as to foster and monitor contributions to policy and regulatory bodies, ensuring OMEGA-X proposals are kept state of the art and the impacts properly mapped on the standardization landscape. The aforementioned groups will be reinforced with Communication activities. OMEGA-X aims at creating an ecosystem fostering the replicability of use cases and solutions together with liaising and interacting with relevant groups in an attempt to attract newcomers to participate in OMEGA-X.





HORIZON-CL5-2021-D3-01-01: Establish the grounds for a common European energy data space

[Back to projects' list](#)

SYNERGIES

Shaping consumer-inclusive data pathways towards the eENERGY transition, through a reference Energy data Space implementation



SYNERGIES introduces a reference Energy Data Space Implementation that will attempt to unleash the data-driven innovation and sharing potential across the energy data value chain by leveraging on data and intelligence coming from diverse energy actors (prioritizing on consumers and introducing them as data owners/providers) and coupled sectors (buildings, mobility) and effectively making them reachable and widely accessible.

From 01/09/2022	Project total cost	EU contribution	Website
To 28/02/2026	10.180.687,50 €	7.972.950,00 €	https://energydataspaces.eu

Technologies and services deployed	Project partners' countries
<ul style="list-style-type: none"> Technologies for consumers Grid technologies Energy Data space Large-scale storage technologies Distributed storage technologies Generation technologies 	

Coordinator	TXT e-solutions spa (IT)
-------------	--------------------------

Other partners:

- INSTITUTE OF COMMUNICATION AND COMPUTER SYSTEMS (EL)
- DIACHEIRISTIS ELLINIKOUDIKTYOUDIANOMIS ELEKTRIKIS ENERGEIAS AE (EL)
- INDEPENDENT POWER TRANSMISSION OPERATOR SA (EL)
- ENERGEIAKI KOINOTITAPERIORISMENISEVTHINIS (EL)
- FUNDACION CIRCE CENTRO DE INVESTIGACION DE RECURSOS Y CONSUMOS ENERGETICOS (ES)
- CUERVA ENERGÍA SLU (formerly MONTAJES ELECTRICOS CUERVA S.L) (ES)
- SUITES DATA INTELLIGENCE SOLUTIONS LIMITED (CY)
- IES R&D (IE)
- ETRA INVESTIGACION Y DESARROLLO SA (ES)
- GIOUMPITEK MELETI SCHEDIASMOS YLOPOIISI KAI POLISI ERGONPLIROFORIKIS ETAIREIA PERIORISMENIS EFTHYNIS (EL)
- ARTHUR'S LEGAL BV (NL)
- TEKNOLOGIANTUTKIMUSKESKUS VTT OY (FI)
- UNIVERSITY OF PELOPONNESE (EL)
- MAGGIOLI SPA (IT)
- DANMARKS TEKNISKE UNIVERSITET (DK)
- BORNHOLMS ENERGI OG FORSYNING AS (DK)
- TREFOR EL NET OST AS (DK)
- PROSPEX INSTITUTE (BE)
- INTERSOFT ROMANIA SOFTWARE SRL ()
- AYUNTAMIENTO DE FORNES (ES)
- TURNING TABLES SOCIEDAD LIMITADA (ES)



Project Description

Context. The energy economy is facing a profound transition from a centralized, fossil-fuel-based system to an energy efficient, renewable-based and more decentralized system. The growing number of distributed energy resources connected to the network affects the accuracy of physical models currently utilized for operational monitoring and planning. An integrated ecosystems of data value chains is needed to enable data driven optimization and coordination between the energy sector stakeholders.

Scope. Synergies promotes the creation of a data-driven intelligence ecosystem that not only supports energy operators in improving efficiency in supply operations but also enables prosumer inclusiveness in market transactions. The main objective consists in promoting an innovative solution based on knowledge sharing and data intelligence integration that includes all energy actors of a complex value chain, considering diverse data sources, heterogeneous energy systems and spanning different socio-economic characteristics.

Technical description and implementation. The project execution comprises 4 main phases based on the type of activities to be performed, covering technical implementation, project management and business innovation planning.

- Phase I – Diagnostics, Analysis and Design: includes the identification of end-user requirements and essential key features for the definition of Synergies technical design.
- Phase II – Technology Configuration and Prototyping: based on the development, configuration and integration of the technical components for real-life operation and validation during large-scale demonstration.
- Phase III – Integration, Deployment and Demonstration: devoted to the project demonstrators, from roll-out to impact assessment of the pilot operation stage.
- Phase IV – Business Innovation: comprises horizontal activities namely dissemination and stakeholder engagement; exploitation planning and standardization.

Impact. *Replicability:* a bundle of data-driven and intelligence-enabled AI services for interoperable data collection and increased availability to be exploited by value chain stakeholders and system operators in several markets
Socio-economics: consumer empowerment through involvement in flexibility transactions, promoting increased resilience of the integrated energy system coupled with other sectors

Environment: promotion of investments in Green technology (RES) and flexible assets (storage, EVs) for 55% reduction of CO₂ by 2030 and full decarbonization by 2050

Market Transformation: Transformation: creation of a new market for data-driven services, through the data value chain integration

Policy: contribution to standardization activities and ongoing work of policy makers and expert groups through targeted policy briefs and recommendations.



HORIZON-CL5-2021-D3-01-02: Laying down the basis for the demonstration of a Real Time Demonstrator of Multi-Vendor Multi-Terminal HVDC with Grid Forming Capability: Coordinated action

[Back to projects' list](#)







READY4DC

Getting ready for multi-vendor and multi-terminal DC technology



Power Electronics is enabling radical transformation in the power grid and, in particular, it is opening the opportunity for a massive application of DC technology. DC technology will increase the overall flexibility and efficiency of the infrastructure. Nevertheless, this innovation comes with challenges in terms of interoperability when we consider networks with multi-vendors. The concrete case of off-shore wind farms is then the starting point for the transformation. READY4DC will create the right conditions to establish a community of experts that will discuss all the implications of the process both from a technical and a legal perspective. Thanks to the work of a set of working groups with open participation, position papers will be produced to create the proper conditions for consensus paving the way towards changes in the regulation and in the legal framework. The results of this work will impact not only the off-shore use cases but, in principle, all the application of power electronics driven grids and at every voltage level, determining a very important step towards a futuristic infrastructure in which DC will play a central role at every level.

From 01/04/2022	Project total cost	EU contribution	Website
To 31/10/2023	999.813 €	999.813 €	https://www.ready4dc.eu/

Technologies and services deployed	Project partners' countries
<p> Technologies for consumers</p> <p> Grid technologies</p> <p> Large-scale storage technologies</p> <p> Distributed storage technologies</p> <p> Generation technologies</p>	<p>HVDC Multi-terminal Protections Inertia Network management Monitoring and control</p> <p>Wind turbine PV</p> 

Coordinator	RHEINISCH-WESTFAELISCHE TECHNISCHE HOCHSCHULE AACHEN (DE)
--------------------	--

Other partners:

- ENTSO-E (BE)
- WINDEU (BE)
- TENNET (DE)
- SUPERGRID (FR)
- RUG (NL)
- TDE (BE)



Project Description

The future electricity network envisioned by READY4DC will be characterized by a growing role of multiterminal multi-vendor (MTMV) HVDC solutions within the current AC transmission networks both onshore and offshore. READY4DC is contributing to this synergistic process by enabling commonly agreed definitions of interoperable modelling tools, model sharing platforms, clear processes for ensuring interoperability, and an appropriate legal and political framework.

Context.

Multi-Vendor/ Multi-Terminal HVDC Grids
Interoperability
Technical and legal perspective

Scope.

Modelling, simulation framework and data sharing
Legal Framework
Interoperability process
Demo requirement and planning

Going beyond the first demo experience

Technical description and implementation.

Coordination Support Action (CSA)
4 working groups
Open to European HVDC stakeholders
Platform for collaboration

Socio-economics:

Vision for sustainability of DC grids including socio-economic aspects

Environment:

Enabling DC grids supports the energy transition

Market Transformation:

Constant dialogue with stakeholders, in particular, HVDC vendors

Policy:

Support enabling policy, legal and regulatory framework, establish dialogue with policy makers, make policy makers aware of suggestions.

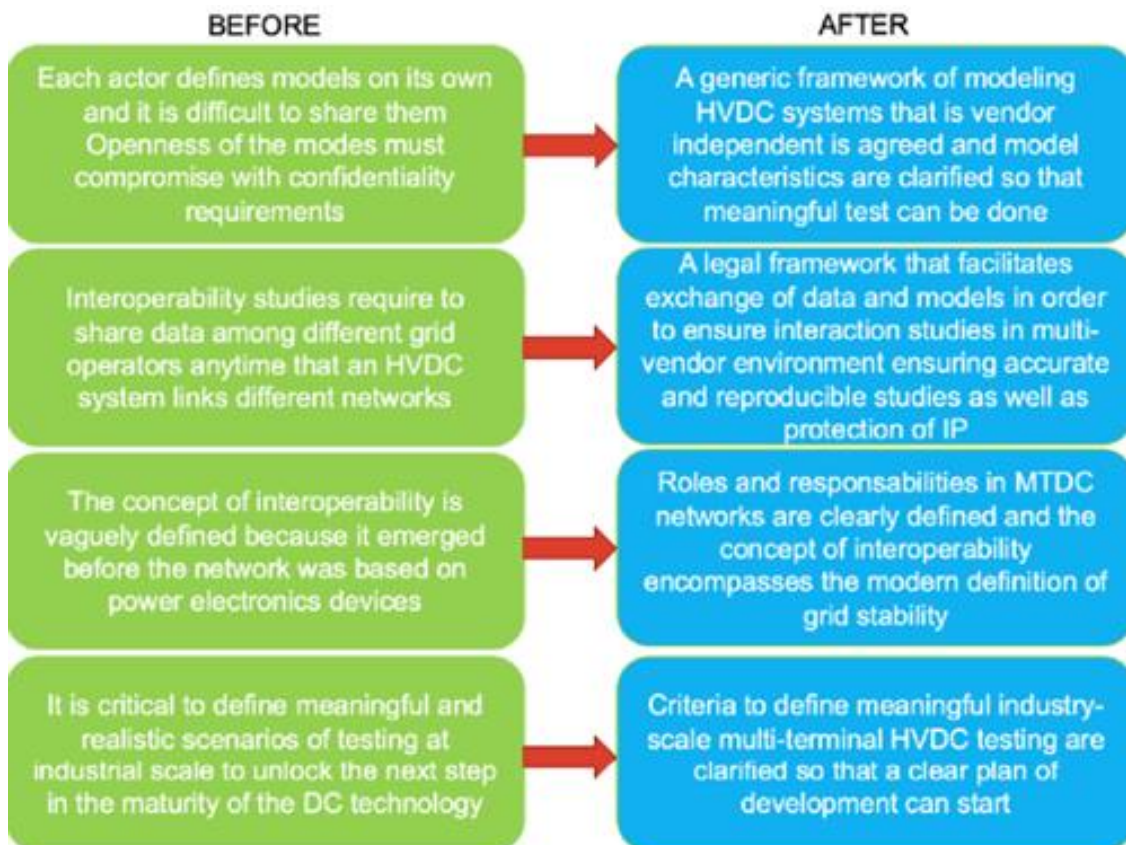

**int:net****Interoperability Network for the Energy Transition**

We establish an open and cross-domain community: The Interoperability Network for the Energy Transition (int:net). Within the int:net-interoperability network we bring together all stakeholders relevant for the European energy sector to jointly work on developing, testing and deploying interoperable energy services

From 2022	Project total cost	EU contribution	Website
To 2025	5 M€	5 M€	www.intnet-project.eu

Technologies and services deployed		Project partners' countries
Technologies for consumers	Demand Response Smart Metering	
Grid technologies	Network management and control tools Micro-grid	
Large-scale storage technologies		
Distributed storage technologies	Batteries Thermal Storage	
Generation technologies	PV Wind Turbines Micro-generation	
Market	Ancillary Services	

Coordinator	FRAUNHOFER GESELLSCHAFT ZUR FOERDERUNG DER ANGEWANDTEN FORSCHUNG E.V. (Germany)
--------------------	--

Other partners:

- AIT AUSTRIAN INSTITUTE OF TECHNOLOGY GMBH (Austria)
- B.A.U.M. CONSULT GMBH (Germany)
- OFFIS EV (Germany)
- EPRI EUROPE DAC (Ireland)
- VDE VERBAND DER ELEKTROTECHNIK ELEKTRONIK INFORMATIONSTECHNIK EV (Germany)
- FUNDACION TECNALIA RESEARCH & INNOVATION (Spain)
- EUROPEAN NETWORK OF TRANSMISSION SYSTEM OPERATORS FOR ELECTRICITY AISBL (Belgium)
- EUROPEAN DISTRIBUTION SYSTEM OPERATORS FOR SMART GRIDS (Belgium)
- EUROPEAN UNIVERSITY INSTITUTE (Italy)
- RHEINISCH-WESTFAELISCHE TECHNISCHE HOCHSCHULE AACHEN (Germany)
- TRIALOG (France)



Project Description

Context. Complex interfaces, costly adaptation efforts, incomparable data sheets and not open-standards hinder adoption of advanced solutions. Unclear terminology, debateable semantics and malfunction stemming from ambiguous information must be avoided. Increasing “adoptability” is the main purpose of standardisation, but existing standards may compete with each other or the standardisation process has not come to its end.

Scope. int:net will foster the harmonisation of interoperability activities on energy services throughout Europe by forming an interdisciplinary network of stakeholders, which will engage in a constant exchange on the topic during the project period and beyond.

Technical description and implementation.

Specifically, int:net will impact the interoperability landscape for energy services by achieving the following objectives:

- A common knowledge base for interoperability activities on energy services in Europe: increase interoperability of energy services, data and platforms, both at the function and business layers by establishing and maintaining a knowledge base of interoperability actions and best practices.
- A comprehensive and accepted Interoperability Maturity Model (IMM): ensure continuity of the ongoing interoperability of energy services related activities by developing an interoperability assessment methodology and the related IMM.
- A framework for interoperability testing in a network of interoperability testing facilities: support and disseminate a common framework for testing interoperability across running projects by harmonising interoperability testing procedures and creating a self-sustained and formally institutionalised distributed “network” of interoperability testing labs.
- A community network for a European interoperability ecosystem: ensure horizontal coordination and support, sustainable up-take of the energy services related to interoperability, data spaces and digital twins by actively involving legal and regulatory framework setters in cross-domain modelling and interoperability testing exercises.

Impact. Replicability: The int:net maturity model combines frameworks that provide means and measures for testing interoperability in a growing network of testbeds and testing laboratories. Experiences from such tests and from setting up favorable frameworks will feed into the knowledge base of good examples, which keeps the circle going.

Socio-economics: int:net will establish a network of a wide range of stakeholders: from academia through legal and regulatory bodies to product developers in industry. This network will define, even beyond project end, comprehensive and consistent sets of models and standards to developed and deployed.

Environment: The achievement of interoperability promoted in int:net will foster the digitalization and decentralisation of energy systems, according to European decarbonisation objectives.

Market Transformation: An interoperability maturity model and an assessment procedure will help organisations to understand their level of maturity in the integration of smart grid technologies, distributed generation and customers with the planning and operation of grids and markets.

Policy: int:net will develop a new governance process, test it and promote it to governmental and regulatory institutions. Participants select and combine technical standards with market requirements in preparation for marketable, interoperable products

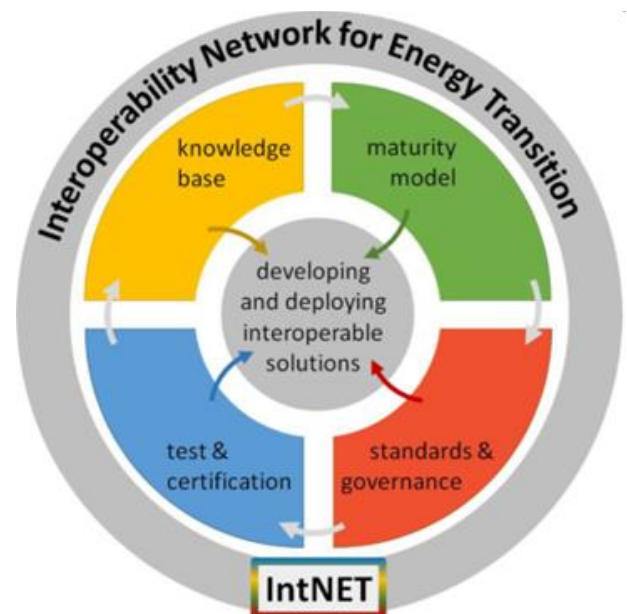

Figure 1 – The int:net knowledge generation and exploitation model



HORIZON-CL5-2021-D3-02-01 Demonstration of wave energy devices to increase experience in real sea condition

[Back to projects' list](#)







WEDUSEA

WAVE ENERGY DEMONSTRATION AT UTILITY SCALE TO ENABLE ARRAYS



WEDUSEA will demonstrate a grid connected 1MW OE35 floating wave energy converter at the European Marine Energy Centre in Orkney, Scotland. This rigorous technical and environmental demonstration will happen over a 2 year period in Atlantic wave conditions with outcomes directly impacting policy, technical standards, public perception and investor confidence.

From 2022	Project total cost	EU contribution	Website
To 2026	19.6 M€	9.6 M€	https://wedusea.eu/

Technologies and services deployed		Project partners' countries
	Technologies for consumers	
	Grid technologies	
	Large-scale storage technologies	
	Distributed storage technologies	
	Generation technologies	
	Power Delivery to the Grid Electricity market	
	Wave Energy Converter	
Coordinator	OceanEnergy (IRL)	

Other partners:

- INNOSEA (FR)
- AST (ES)
- Fraunhofer IEE (DE)
- MaREI UCC (IRL)
- Gavin Doherty Geosolutions (IRL)
- Exceedence (IRL)
- Wood Group (IRL)
- Hydro Group (UK)
- European Marine Energy Centre (UK)
- Longitude Engineering (UK)
- INNOSEA Ltd (UK)
- Green Marine UK (UK)



Project Description

Context. WEDUSEA led by Irish Wave Energy Developer, Ocean Energy, will demonstrate a grid connected 1MW OE35 floating wave energy converter (known as the OE Buoy) at the European Marine Energy Centre (EMEC) in Orkney, Scotland. This rigorous technical and environmental demonstration will happen over a 2-year period in Atlantic wave conditions with outcomes directly impacting policy, technical standards, public perception and investor confidence. The project will demonstrate that the technology is on a cost reduction trajectory in line with the EU SET Plan targets and will be a stepping stone to larger commercial array scale up and further industrialisation.

Scope. Phase 1 and 2 will implement the demonstration at the EMEC test site. The project will have an overall duration of 4 years to enable a 2-year deployment period at sea to adequately demonstrate the critical innovations, power production, availability and reliability, especially during the two over-winter periods. Phase 3 will be the dissemination, commercialisation and exploitation of the project results

Technical description and implementation.

This project will demonstrate the potential for offshore renewable wave energy to make a significant contribution to achieving the European Union Green Deal target. The project will Demonstrate a large-scale Wave Energy Device to Increase Experience in Real Sea Conditions with a 24 month deployment period to confirm performance, availability and reliability. The Ocean Energy (OE) Wave Energy Converter (WEC) – the OE Buoy Floating Oscillating Water Column

(FLOWC) Device is a leading candidate for successful commercialisation and scale up to utility size wave farms. It utilises well proven ship- building construction and there is only one moving part, not in contact with the sea, so higher reliability and availability will be expected compared to other wave energy converters.

Impact. Replicability: Successful operation over a two year period of a commercial scale WEC, in conjunction with achieving LCOE targets and proving benign environmental impact will give credibility to the marine energy industry. This in turn will attract investment, which will lead to the development of arrays of WECs, creating jobs and energy security. The pathways identified map out the route to achieve this, contributing to the targets outlined in the European Green Deal and to the Clean Energy Transition.

- Technology suitable for mass production
- Competitive LCOE based on reliability, availability and power quality
- International accreditation and certification
- Realisation of multi-MW array deployments to contribute to the renewable energy mix
- Acceptance of environmental impacts from prolonged deployments

- Public awareness and acceptance of wave energy as a favourable renewable energy source.
- Contribute to the achievement of UN Sustainable Development Goals

Socio-economics: The project will demonstrate that the technology is on a cost reduction trajectory in line with the EU SET Plan targets and will be a stepping stone to larger commercial array scale up and further industrialisation. The project will enhance citizen engagement with wave energy as a legitimate contributor to the renewable energy mix with a benign or positive environmental impact.

Environment: Studies to date have been undertaken on small scale or limited time deployments of wave energy devices. This project will provide the first data for the potential impacts for underwater and airborne noise as well as the interaction with birds for a large-scale device extended deployment.

Market Transformation: Wave Energy Farm Project Developers will benefit from the reduction of the risk profile associated with the technology through Certification activities in the project, and improved information on the long term environmental impact. Electricity Utilities. A de-risked commercial scale WEC with an established performance profile will be an attractive investment opportunity and addition to the renewable energy mix of the future.

Policy: Energy and Marine Spatial Planning Policy Makers. A two year deployment with extensive environmental monitoring would inform future projects and lends itself to the de-risking sentiment of this project. Industry technology developers will benefit from the project

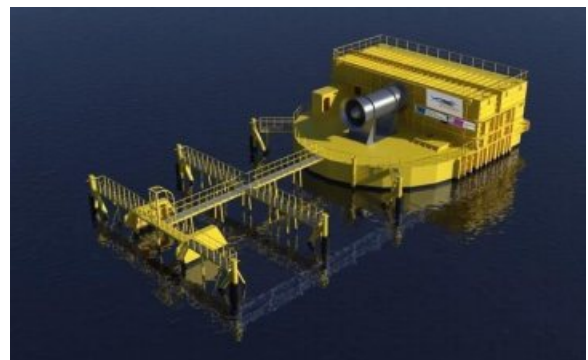

findings of the extended deployment, environmental assessment and contributions to the IEC standards.



HORIZON-CL5-2021-D3-02-05: Energy Sector Integration: Integrating and combining energy systems to a cost-optimised and flexible energy system of systems

[Back to projects' list](#)

SENERGY NETS

Increase the synergy among different energy networks



SENERGY NETS aims at demonstrating the technical and economic capability of multi-energy systems to decarbonise the heating and cooling, power and gas sectors through renewable energy sources produced locally as well as sector integration, by primarily focusing on promising infrastructure and business models.

From 2022	Project total cost	EU contribution	Website
To 08/2026	9.9 M€	8.2 M€	https://senergynets.eu/

Technologies and services deployed | **Project partners' countries**

<ul style="list-style-type: none"> Technologies for consumers Grid technologies Large-scale storage technologies Distributed storage technologies Generation technologies 	<p>for</p> <ul style="list-style-type: none"> Demand response Smart metering Dynamic thermal rating HVAC Network management Monitoring & control tools <ul style="list-style-type: none"> Batteries EV Thermal energy storage CNG compressor PV Solar thermal Biomass 	
--	--	--

Coordinator | **EIFER (Germany)**

Other partners:

- ELECTRICITE DE FRANCE (France)
- AZA SPA (Italy)
- AZA CALORE & SERVIZI SRL (Italy)
- ASSOCIAZIONE ITALIANA RISCALDAMENTO URBANO (Italy)
- CYBERGRID GMBH & CO KG (Austria)
- EUROHEAT & POWER (Belgium)
- ELEKTRO LJUBLJANA PODJETJE ZADISTRIBUCIJO ELEKTRICNE ENERGIJE D.D. (Slovenia)
- JAVNO PODJETJE ENERGETIKA LJUBLJANA DOO (Slovenia)
- OPERATO (Slovenia)
- RICERCA SUL SISTEMA ENERGETICO - RSE SPA (Italy)
- UNARETI Spa (Italy)
- MALARDALENS UNIVERSITET (Sweden)
- UNIVERSITAET KASSEL (Germany)
- DALKIA (France)
- FUNDACION TECNALIA RESEARCH & INNOVATION (Spain)
- VEOLIA SERVICIOS LECAM SOCIEDAD ANONIMA UNIPERSONAL (Spain)
- UNIVERZA V LJUBLJANI (Slovenia)
- FEDERCONSUMATORI MILANO APS (Italy)



Project Description

Context. SENERGY NETS aims at demonstrating the technical and economic capability of multi-energy systems to decarbonize the heating and cooling, power and gas sectors through renewable energy sources produced locally as well as sector integration, by primarily focusing on promising infrastructure and business models.

Scope. The objective is to develop a set of tools and platforms (up to TRL7/8) aimed to optimize the planning and operation of District Heating and Cooling as well as distribution grids with sector coupling consideration and allow the provision of flexibility services to Distribution and Transmission System Operators. The solutions developed in SENERGY NETS will be implemented on three pilot sites located in Milan (IT), Ljubljana (SI) and Paris (FR) and their replicability will be tested in two additional real case studies in Västerås (SW) and Cordoba (ES).

Technical description and implementation.

- (Further) development of a set of planning tools for the design and simulation of MES (multi-carrier and networks), pluri-annual planning and operational planning of the distribution grid considering flexibility provision from MES for DSO.
- Development and testing of an optimized flexibility trading tool, building up on the prototype developed in MAGNITUDE. Using flexibility and price forecasts importation, it will calculate the market bids with best revenue expectations.
- To support the demonstration of flexibility provision from MES to DSO, an auxiliary platform based on the INTEGRID project will be developed and tested.
- Development of a methodology for the evaluation of the overall (technical, economic, environmental, social) value created by sector integration.

Impact. Replicability: The SENERGY NETS solutions will be tested by MES operators (DHC) and DSO, allowing DSO and MES operators to integrate this possibility in further activities.

Socio-economics: SENERGY NETS solutions will enable DHC systems to reduce their carbon emissions by shifting the peak loads and optimizing their energy mix. They will also contribute to the reduction of energy poverty and increase of end user's involvement, as DHC are less influenced by the fluctuation of gas and electricity prices according to their share of renewable energy. Outage probabilities will also be reduced, thus increasing the quality of services provided by the DSO to its customers.

Environment: The use of already available MES for flexibility provision should reduce the use of existing dedicated industrial power plants and the construction of new ones. As a consequence, it limits impact on land use and air quality, thus preserving the local environment and living space quality.

Market Transformation: The development of ancillary services markets (ASM) for DSO will bring additional revenue to MES and might reduce the flexibility needs on the transportation grids by managing the integration of RES and new usages of electricity closer to the source.

Policy: The consortium will develop policy recommendations to foster the creation of a supportive regulatory framework in the field of energy systems integration and energy market strategy in line with the 2030 and 2050 goals.

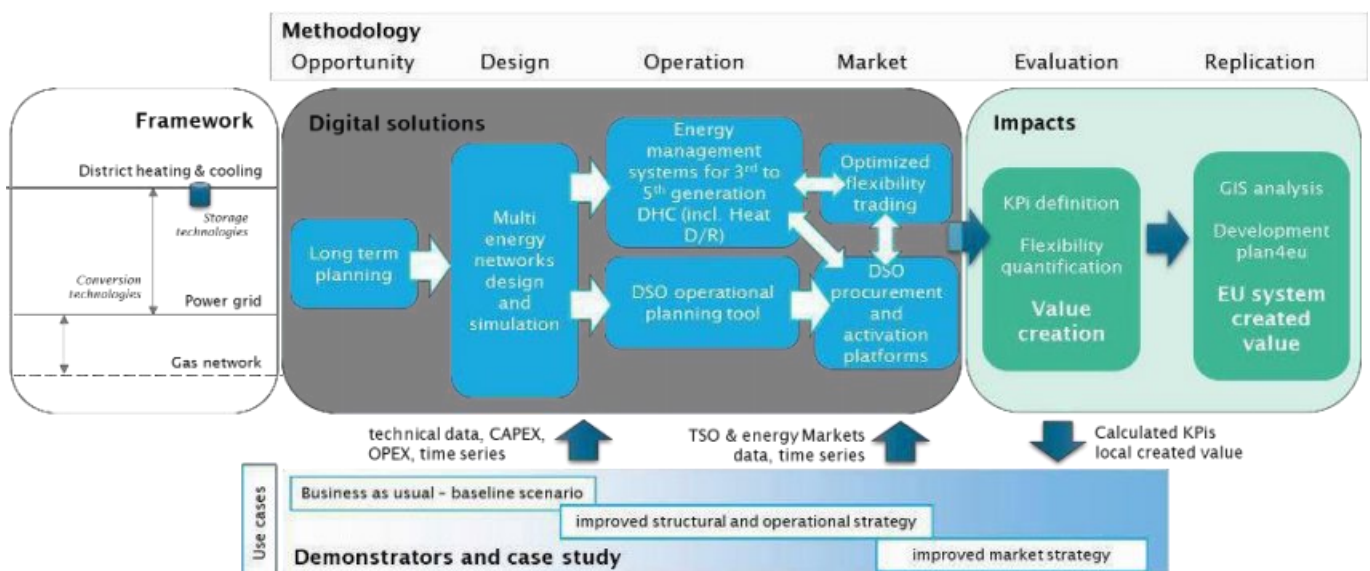



HORIZON-CL5-2021-D3-02-05: Energy Sector Integration: Integrating and combining energy systems to a cost-optimised and flexible energy system of systems

[Back to projects' list](#)



ELEXIA

Demonstration of a digitized energy system integration across sectors enhancing flexibility and resilience towards an efficient, sustainable, cost-optimised, affordable, secure and stable energy supply



The ELEXIA project aims at developing tools for planning and managing integrated energy systems and demonstrating the tools at three pilot sites, supporting the transition towards digitalized, resilient and flexible energy systems

From 2022	Project total cost	EU contribution	Website
To 30/09/2026	11.0 M€	9.55 M€	https://elexia-project.eu/

Technologies and services deployed		Project partners' countries
	Technologies for consumers	
	Grid technologies	
	Distributed storage technologies	
	Generation technologies	
	Market	
	Demand response Smart appliance Smart metering Network management, monitoring and control tools Batteries Electric Vehicles Thermal Energy Storage Flywheel Wind Turbine PV Biogas Micro-generation Ancillary Services Electricity market	

Coordinator

NORCE NORWEGIAN RESEARCH CENTRE AS

Other partners:

- EDP LABELEC (Portugal)
- UNIVERSITY OF DURHAM (United Kingdom)
- TECHNICAL UNIVERSITY OF DENMARK (Denmark)
- VTT TECHNICAL RESEARCH CENTRE OF FINLAND LTD (Finland)
- FUNDACIÓN TECNALIA RESEARCH & INNOVATION (Spain)
- CENTER DENMARK APS EU Digital Innovation Hub
- HØJE-TAASTRUP MUNICIPALITY (Denmark)
- CITY OF BERGEN (Norway)
- TMROW APS (Denmark)
- BIR AS (Norway)
- BIR NETT AS (Norway)
- WINGS ICT SOLUTIONS INFORMATION & COMMUNICATION TECHNOLOGIES IKE (Greece)
- WESTEGENS KRAFTVARMESELSKAP IS (Denmark)
- CORE INNOVATION (Greece)
- CORE INNOVATION CENTRE NPO (Greece)
- ENFOR (Denmark)
- BKK NETT AS (Norway)
- EVINY TERMO AS (Norway)
- APS - ADMINISTRACAO DOS PORTOS DE SINES E DO ALGARVE, S.A. (Portugal)
- AMCTECH (Poland)
- CLIMIFY APS (Denmark)



Project Description

Context. Energy system integration (ESI) is the pathway towards an effective, affordable, and deep decarbonisation of the European economy. Linking sectors will allow optimisation of the energy system as a whole, rather than decarbonising and making separate efficiency gains in each sector independently. Most of today's energy systems in Europe are not integrated, resulting in large quantities of unutilized surplus of energy. In these systems energy and resources are neither reused (like waste heat) nor are they designed cross- sectoral or circular. They are furthermore mostly not planned, managed, or optimised in an holistic approach. The digital transition and the integration of all relevant stakeholders from citizens to public authorities and entrepreneurs are key enablers in a safe, cybersecurity and fair implementation of the future energy systems.

Scope. The main objective of ELEXIA is to **develop validated tools for planning and managing integrated energy systems across different energy vectors and sectors**, towards a cost-optimised, flexible and resilient energy system. ELEXIA will demonstrate the use of the planning and operational tools in a modular and open, digital platform in three pilot sites. ELEXIA will demonstrate realistic and concrete pathways to ultimately achieve independence of fossil fuels by harnessing the latent flexibility of the energy system through integration, data-intelligence, and planning, focusing on three large pilots and working towards the 2050 EU goals.

Technical description and implementation. The tools developed within the project include 1) a **System Planning Toolbox** to support effective sector coupling at local sites, considering the conflicting interests of multiple actors; 2) **Energy Management Systems** for flexible, cost- optimised, and resilient operation of sector coupled local sites; and 3) a **Digital Services Platform** to host the energy management and planning services and to foster flexibility and sector coupling; consisting of the whole digitalization hierarchy from smart edge devices to cloud services.

To demonstrate the benefits of sector integration and flexibility in different geographical, climate and economic conditions throughout Europe and to train local stakeholders, three pilots are conducted in an **industrial port environment in Sines (Portugal)**, in an **urban-city hub environment in Høje Taastrup-Copenhagen (Denmark)**, and in an **industrial-urban-residential environment in Bergen (Norway)**.

For ecosystem building, the tools and demonstration sites are considered from various perspectives, including life cycle assessment (LCA), emissions reductions assessment, cost-benefit analysis, and assessment of the social impacts. Special attention is paid to building a community of stakeholders, delivering policy and governance recommendations, exploitation, replication, and ensuring audience-targeted communication.

Impact. *Replicability:* A 'replication kit' addressing technical challenges, barriers and bottlenecks is created to ease the implementation of ELEXIA solutions. Replication of the ELEXIA outcomes is aiming to reach 21 direct replication cases/sites with up to 1 million citizens and over 50 TWh/year engaged by 2030.

Socio-economics: By addressing EU policy priorities and global challenges, ELEXIA aims to contribute to reduction energy demand (-20-25% by 2030), demand from the grid (-40%), to SDGs, and renewable cost reduction (-15%). Resulting energy cost reductions, access to flexibility services and sector coupling could contribute to revenue increase by over 112 M€, job creation of at least 940 jobs, and over 35 M€ investments in R&I projects.

Environment: With ELEXIA contribution to reducing energy demand, CO2 emissions could reduce by 45-55%, with over 87 M€/y in energy and CO2 tax savings. The resulting integrated energy system promotes circular and less wasteful energy economy.

Market Transformation: The creation of integrated energy system ecosystem will contribute to regulatory frameworks for market integration, infrastructures, and carbon cost internalization.

Policy: ELEXIA will provide feedback to policy measures and generate knowledge and policy input for regulatory framework at EU level. The project outcomes are expected to provide for e.g. EU Energy Systems Integration Strategy, implementation of National Energy and Climate Plans (NECPs), EU Energy Efficiency Directive, and EU Green Deal. Additionally, ELEXIA will have a great impact and contribution to the creation to the strategic goal of a Common EU Energy Data Space.





HORIZON-CL5-2021-D3-02-05: Energy Sector Integration: Integrating and combining energy systems to a cost-optimised and flexible energy system of systems

[Back to projects' list](#)







FEDECOM



FEDERated "system of systems" approach for flexible and interoperable energy COMMunities

FEDECOM, FEDERated "system of systems" approach for flexible and interoperable energy COMMunities, coordinated by Veolia, focuses on the implementation of integrated local energy systems through sector coupling and cross-energy vector integration. The project will provide a scalable and adaptable cloud platform consisting of analysis, modelling, and optimization services for planning, monitoring and control of integrated local energy systems.

From 1 Oct 2022	Project total cost	EU contribution	Website
To 30 Sep 2026	9.5 M€	7.6 M€	www.fedecom-project.eu

Technologies and services deployed		Project partners' countries
	Technologies for consumers	
	Grid technologies	
	Large-scale storage technologies	
	Distributed storage technologies	
	Generation technologies	
	Demand response Smart appliances	
	Network management tools	
	Power to gas, Hydro storage	
	Power to Heat, Batteries Electric Vehicles	
	PV Solar Thermal	

Coordinator VEOLIA (Spain)

Other partners:

- Fundacion Tekniker (Spain)
- Universite Catholique De Louvain (Belgium)
- Fraunhofer Gesellschaft Zur Forderung Der Angewandten Forschung Ev (Germany)
- Iberdrola (Spain)
- R2M Solution (Spain)
- Grid Singularity (Germany)
- Institut Mihajlo Pupin (Serbia)
- AUG-e (Belgium)
- ENBRO (belgium)
- Smart Energy Europe (Belgium)
- Energies 2050 (France)
- UR BEROA (Spain)
- Azienda Elettrica Di Massagno (Switzerland)
- Hive Power (Switzerland)
- Scuola Universitaria Professionale Della Svizzera Italiana (Switzerland)
- Heriot-Watt University (UK)



Project Description

Context. It is essential to invest and advance on solutions for energy system decarbonisation that will improve the penetration of renewable energy sources (RES). At the same time, the growth of energy production from RES introduces several technological and financial challenges to the traditional energy grid model. This increases the operational costs and needed capital investments for the grid operators to maintain the energy security of European citizens. The key to tackling these barriers is the ability to predict, control and manage intermittent energy sourcing for highly variable load profiles. As the world is on a quest to find the “cure” for this problem, one of the potential solutions is seen in sector coupling across energy vectors to introduce additional degrees of freedom for energy conversion and dispatching, enhancing the local RES hosting capacity and unlocking the demand flexibility potential.

Scope. FEDECOM will develop the technical and business ecosystem to convincingly demonstrate the potential of energy sector coupling, by integrating the local energy systems across the federation of communities, to bring economic benefits, improve grid stability and reliability, contribute to the energy system decarbonisation.

Technical description and implementation.

FEDECOM valorises RES enabled sector coupling opportunities (e.g. across power, gas, heating mobility), by following the multi-layered federated ‘System of Systems’ (SoS) approach. Operatively, the project will carry out an iterative “measure-forecast-optimise- control” loop:

- **Measure:** FEDECOM monitors systems/assets at grid side and demand side and delivers user-tailored services (e.g. comfort control, EV charging, H2 production) owing to the system modelling and predictive analytics.
- **Forecast:** FEDECOM performs the prediction of energy generation and energy demand profile. Demand-side predictive analytics consider building and community (aggregated) level forecasting, as well as demand flexibility estimation across energy assets and loads, while predictive grid state estimation identifies potential grid operation ‘bottlenecks’. This way, FEDECOM is aware of the future energy profiles, grid state, and demand flexibility, in intra-day and day-ahead timespans.
- **Optimise:** following a multi-layered federated SoS approach (as shown in the following figure), FEDECOM will deploy distributed optimisation services to identify the optimal management strategy and scheduling of integrated energy systems, such as joint grid power flow and integrative cross-vector optimization.
- **Control:** Model

predictive control (MPC) algorithms will enable optimal energy profiles and to identify energy flows into the specific control setpoints. A reduced-order building and system-level modelling will leverage the MPC services, while the control strategy identified by integrative

optimization will serve as an input for identification of the control setpoints (e.g. temperature, water pump control, battery SoC).

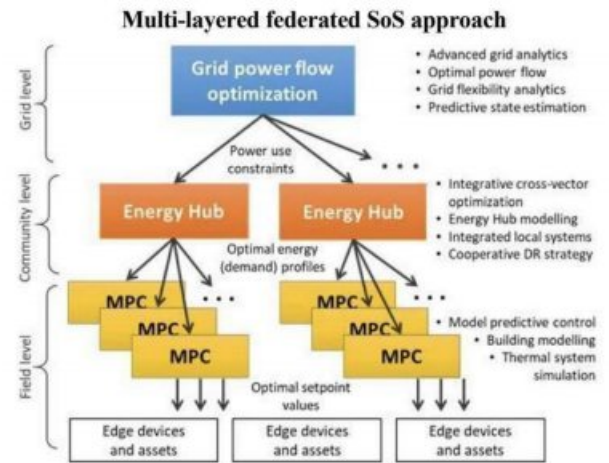

Impact.

Replicability: There will be 3 “follower” communities involved. The project will prepare the replication plans to capture all pertinent guidelines that support the adoption of FEDECOM solution by partners outside the consortium.

Socio-economics: Over 20% final energy savings; • Up to 30% saving in total grid CAPEX and OPEX by cross-energy vector coupling and DR services, together with improved system stability and reduce grid maintenance; • Increased consumer engagement and joint investments in DR and renewable energy solutions.

Environment: Increased local RES hosting contributing to EU 2030 target of 40% share; • Contribution to EU 2030 target for GHG emission reduction of at least 55%;

Market Transformation: Over 30% of total load available for grid balancing and ancillary services, unlocking demand side flexibility of energy communities; • Cross-platform and smart grid interoperability, facilitating replication of concepts across stakeholders and sectors.

Policy: FEDECOM project pilots will be studied, with different market readiness levels with regards to regulatory framework and community establishments. • Policy related issues will be analysed under BRIDGE initiative, identifying legislative barriers and providing feedback.



HORIZON-CL5-2021-D3-02-06: Increasing energy system flexibility based on sector-integration services to consumers (that benefits system management by DSOs and TSOs)

[Back to projects' list](#)







BEFLEXIBLE



Boosting Engagement to Increase Flexibility

BEFLEXIBLE project aims to increase the flexibility of the energy system, improve cooperation between Distribution System Operators (DSOs) and Transmission System Operators (TSOs) and facilitate the participation of all energy-related stakeholders.

From 2022	Project total cost	EU contribution	Website
To 31/08/2026	10 M€	8 M€	www.BEFLEXIBLE.eu

Technologies and services deployed		Project partners' countries
	Technologies for consumers	
	Grid technologies	
	Large-scale storage technologies	
	Distributed storage technologies	
	Generation technologies	
	Market	
	Demand response Smart appliances Smart metering Network management, monitoring and control tools Micro-grid Hydro storage Batteries Electric Vehicles PV Ancillary Services Electricity market	

Coordinator	i-DE (SPAIN)
--------------------	---------------------

Other partners:

- IBERDROLA ENERGIA ESPANA SAU (Spain)
- ENEL GLOBAL INFRASTRUCTURE AND NETWORKS S.R.L. (Spain)
- EDISTRIBUCION REDES DIGITALES SL (Spain)
- E-DISTRIBUZIONE SPA (Italy)
- Gridspertise s.r.l. (Italy)
- TERNA - RETE ELETTRICA NAZIONALE SPA (Italy)
- ARETI S.P.A. (Italy)
- RICERCA SUL SISTEMA ENERGETICO - RSE SPA (Italy)
- E ON ENERGIDISTRIBUTION AB (Sweden)
- E.ON Energiinfrastruktur (Sweden)
- SAP SE (Germany)
- SCHNEIDER ELECTRIC ESPANA SA (Spain)
- UNIVERSIDAD PONTIFICIA COMILLAS (Spain)
- INESC TEC- INSTITUTO DE ENGENHARIA DE SISTEMAS E COMPUTADORES, TECNOLOGIA E CIENCIA (Portugal)
- RHEINISCH-WESTFAELISCHE TECHNISCHE HOCHSCHULE AACHEN (Germany)
- ENGINEERING - INGEGNERIA INFORMATICA SPA (Italy)
- STEMY ENERGY (Spain)
- THERMOVAULT (Belgium)
- SOULSIGHT DESIGN STRATEGY, S.L. (Spain)
- SMART INNOVATION NORWAY AS (Denmark)
- TIME.LEX (Belgium)
- EUROPEAN DISTRIBUTION SYSTEM OPERATORS FOR SMART GRIDS (Belgium)
- ZABALA INNOVATION CONSULTING, S.A. (Spain)



Project Description

Context. Currently, energy production and use account for around 72% of the EU's greenhouse gas emissions. The EU's objective is to establish a modern design for the electricity market, adapted to the new commercial realities: more flexible, market-based, and better placed to integrate a higher share of renewables. The BEFLEXIBLE project is aligned with the current climate targets and the Fit for 55 packages, in addition to the Recovery Plan and the actions and roadmaps implemented by the European Technology & Innovation Platform Smart Networks for Energy Transition (ETIP SNET) actions to ensure this pathway.

The renewable energy generated is increased. Moreover, there is no longer a single area of production that is then distributed in one area but is generated from more and more places and then distributed. This is affecting electricity markets. The system demands flexibility and new business models for traditional utilities and distribution companies.

Scope. BEFLEXIBLE aims to overcome existing limitations by applying versatile solutions that allow grids to adapt to upcoming scenarios. Thus, it will promote mechanisms that provide benefits to all actors in the energy market (from market operators to end users), responding to all types of consumer needs. BEFLEXIBLE's objective is to increase the flexibility of the energy system, improve cooperation between Distribution System Operators (DSOs) and Transmission System Operators (TSOs) and facilitate the participation of all energy-related stakeholders.

Technical description and implementation. The BEFLEXIBLE project is based on 4 main blocks.

- Firstly, an analysis of markets and regulations will be carried out and a flexible framework for new business opportunities will be defined.
- Secondly, the definition and adaptation of the service ecosystem offering a broad portfolio of flexibility and cross-sector solutions for end-users will be carried out.
- The third point consists of the implementation of platforms and architectures, including the design of a Grid Business and Data Network (GDBN) and the definition of the system architecture to ensure full data interoperability.
- Finally, BEFLEXIBLE will focus on customer engagement and a social co-creation approach to meet the consumer's needs.

The versatility of the concept will be demonstrated in various and diverse environments, in terms of consumer types, geographic and climatic areas and energy loads, to assess the impact of services, platforms and architectures. Consumer engagement strategies will be validated to enable appropriate interaction between all energy actors and foster market uptake. A heterogeneous set of pilots will be deployed with demos in Italy, Sweden, Spain and France. The pilots have been selected to cover a wide range of consumer energy behaviours, grid typologies, and

climate conditions. The different regulatory environments and alignment with national plans for the 2030 energy transition will allow to test the solutions for the market.

Impact. BEFLEXIBLE Consortium has designed a pathway to ensure that the BEFLEXIBLE results will contribute to design a whole value chain framework within the energy and cross-sector for flexibility-centric services, creating a services ecosystem that will include energy, cross-sector and customer-centric services on one hand, and grid-operators-centric services on the other hand. This will ensure liquidity for a well-functioning electricity market.

The strategy for the exploitation will allow to define the pathway for the mid-term new profitable business models which will enable a smooth market introduction and proper orientation of the future services.

Also an ethical and regulatory framework for a common and easy data space exchange will be designed to enable different flows of information supporting flexibility-centric business models elaborate. A co-creative strategy to increase social acceptance will be defined in order to foster actual participation, minimise the intention-behavior gap and increase participation of consumers in flexibility markets.

The Scalability and Replicability Analysis will estimate the potential and define the pathway at a pan-European scale through BEFLEXIBLE demonstrated solutions for achieving simplicity through the definition of user-friendly interfaces, low entry barriers and automated solutions.





HORIZON-CL5-2021-D3-02-06: Increasing energy system flexibility based on sector-integration services to consumers (that benefits system management by DSOs and TSOs)

[Back to projects' list](#)

ENFLATE

ENabling Flexibility provision by all Actors and sectors through markets and digital Technologies



ENFLATE aims at developing and demonstrating in 6 Demonstration campaigns across 5 countries, a collaborative platform of tools enabling consumer-driven business models for energy services, valorising their multi-vector flexibility potential and integrating them with other non-energy services (cross-industry services), like health and mobility services.

From 2022	Project total cost	EU contribution	Website
To 31/08/2026	14.3 M€	7.6 M€	https://enflate.eu/

Technologies and services deployed		Project partners' countries
	Technologies for consumers	
	Grid technologies	
	Large-scale storage technologies	
	Distributed storage technologies	
	Generation technologies	
	Demand response Smart appliances Smart metering Network management, monitoring and control tools Batteries EVs Thermal energy storage PV Solar thermal Micro-generation	

Coordinator NOVA (GREECE)

Other partners:

- UBITECH ENERGY (Belgium)
- CORDIS NAMEETHNIKO KENTRO EREVNAS KAI TECHNOLOGIKIS ANAPTYXIS (Greece)
- ARTELYS (France)
- FUNDACION CARTIF (Spain)
- ETHNIKO KAI KAPODISTRIAKO PANEPISTIMIO ATHINON (Greece)
- EUROPAISCHES INSTITUT FUR INNOVATION - TECHNOLOGIE EV (Germany)
- REGULATORY AUTHORITY FOR ENERGY (RYTHMISTIKI ARHI ENERGIAS) (Greece)
- DIACHEIRISTIS ELLINIKOU DIKTYOU DIANOMIS ELEKTRIKIS ENERGEIAS AE (Greece)
- INDEPENDENT POWER TRANSMISSION OPERATOR SA (Greece)
- UNIVERSITY OF PIRAEUS RESEARCH CENTER (Greece)
- DIMOS SKIATHOU (Greece)
- EPEX SPOT (France)
- MONTAJES ELECTRICOS CUERVA S.L. (Spain)
- TURNING TABLES SOCIEDAD LIMITADA (Spain)
- AYUNTAMIENTO DE LACHAR (Spain)
- EKSTA BOSTADSAKTIEBOLAG (Sweden)
- IVL SVENSKA MILJOEINSTITUTET AB (Sweden)
- NODAIS AB (Sweden)
- BLOKS ZDRAVNI I SOTSIALNI GRIZHI EOOD (Bulgaria)
- YUGOIZTOCHNOEVROPEYSKA TEHNOLOGICHNA KOMPANIA OOD (Bulgaria)
- ELECTRODISTRIBUTION GRID WEST AD (Bulgaria)
- ELEKTROENERGIEN SISTEMEN OPERATOR EAD (Bulgaria)
- FACHHOCHSCHULE ZENTRALSCHWEIZ - HOCHSCHULE LUZERN (Switzerland)
- St. Gallisch-Appenzellische Kraftwerke AG (Switzerland)
- TRANSPORTS PUBLICS GENEVOIS (Switzerland)
- UNIVERSITE DE GENEVE (Switzerland)
- Hitachi ABB Power Grids Ltd. (Switzerland)
- TECH INSPIRE LTD (United Kingdom)



Project Description

Context. The European Commission’s policy framework (i.e., Clean Energy Package, FIT 55) seeks to decarbonise the energy system, encouraging the electrification of heat and transport, as well as the connection of more clean but intermittent generation. Electricity markets and smart grid digitalization should proceed very fast to enable the fulfilment of these targets, incentivizing energy consumers and maximizing the use of assets from different energy consumption sectors (i.e., electricity, water, heating, cooling, mobility) in order to fully exploit the flexibility services.

Scope. ENFLATE aims to upgrade already demonstrating solutions for data-driven energy, health and mobility services for consumers, substantiating also on the application of innovative technical solutions, market designs and business models, and replicate them in different European countries mobilising flexibility resources for the provision of grid services. It proposes a multi-level architecture for consumer-centred flexibility platforms, that will be tested in Bulgaria, Greece, Spain, Sweden and Switzerland engaging local consumers, TSOs, DSOs, market operators, regulatory authorities and service providers. Moreover, it develops smart grid innovative technologies and peer-to-peer market platforms for consumers and facilitates the provision of smart building and local community cross vector flexibility services, as well as the integration of consumer-centred flexibility with pan European spot markets.

Technical description and implementation. Building upon already demonstrated solutions in relevant and operational environments (i.e., tools from on-going EU projects such as OneNet, LocalRES and initiatives such as ENERA), ENFLATE proposes a secure and interoperable platform of tools for valorisation of cross-energy carrier flexibility, as well as services for mobility and health. ENFLATE data management platform will integrate:

- A decentralized flexibility marketplace for small-scale DERs based on DLT infrastructure;
- An integrated marketplace for local flexibility coordinating TSOs, DSOs, FSPs;
- A scalable cloud platform for LEC operators including an IoT platform integrated with a digital twin of the grid;
- A digital structure with real-time data-driven control algorithms for both a heat network and buildings; and
- A tool for efficient energy management of an electrified mobility infrastructure.

The building blocks of the ENFLATE platform are the development and testing of enhanced grid assets control, the utilization of data management methods for the data stemming from physical systems, the digitalization of existing assets and process and the interoperability with existing TSO/DSO architectures.

Impact.

Replicability: ENFLATE proposes an interoperable platform that can connect to already existing platforms (developed in previous H2020 projects) ensuring its scalability and utilizes the capabilities of the ARTELYS ACSG modelling platform (a solution dedicated to the modelling and simulation of energy systems on a continental, national or regional scale, specialised in techno-economic analyses) to ensure its replicability.

Socio-economics: ENFLATE contributes to the mitigation of energy poverty providing increased revenue streams to consumers through the provision of flexibility services. It also contributes to the provision of better healthcare and life-assisted at home services to elderly people and of enhanced public transport services. In addition, it ensures cost-effective supply of energy by reducing the need for grid upgrades, and by reducing voltage abnormalities and congestions in the grid.

Environment: ENFLATE contributes to the reduction of the carbon footprint by increasing the efficiency of urban mobility and by reducing the RES curtailmen

Market Transformation: ENFLATE enables market parties to provide flexibility services to system operators and the wholesale market based on competitive markets that are easily accessible and at low transaction costs. Moreover, it proposes new business models putting the consumer at the centre of flexibility markets.

Policy: ENFLATE analysis on regulatory frameworks will highlight the existing barriers hindering the provision of cross-sector services resulting in policy recommendations.

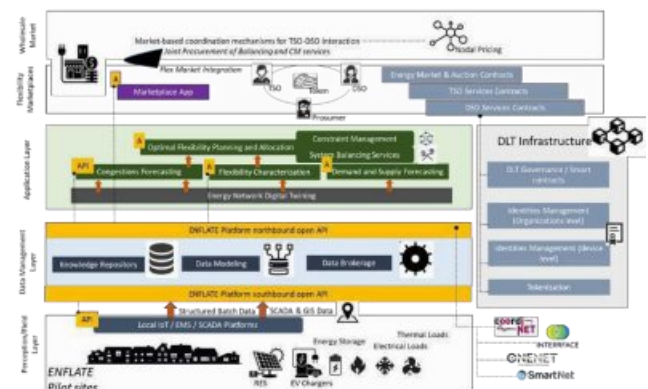



HORIZON-CL5-2021-D3-02-06: Increasing energy system flexibility based on sector-integration services to consumers (that benefits system management by DSOs and TSOs)

[Back to projects' list](#)

STREAM

Streaming Flexibility to the Power System

STREAM

STREAMING FLEXIBILITY TO THE POWER SYSTEM

The ambition of the STREAM project (STREAM) is the creation of an innovative and robust flexibility ecosystem on the low voltage (LV) grid side of existing power markets connecting data, technologies, stakeholders and markets, thus facilitating the flexibility provision.

From 01/10/2022

Project total
cost

EU contribution

Website

To 30/09/2023

10.4 M€

7.9 M€

<https://stream-he-project.eu/>

Technologies and services deployed

Project partners' countries



Technologies for consumers

Demand response
Advanced flexibility provision



Grid technologies

Network management and control tools



Large-scale storage technologies

Large scale batteries



Distributed storage technologies

E-mobility
Virtual power plant



Generation technologies

Better utilization of existing generation



Market

Local Flexibility Market
Ancillary services market (DSO & TSO)



Coordinator

University of Ljubljana (Slovenia)

Other partners:

- ETRA INVESTIGACION Y DESARROLLO SA (Spain)
- OMI-POLO ESPANOL SA (Spain)
- BORZEN, OPERATER TRGA Z ELEKTRIKO, D.O.O. (Slovenia)
- CYBERGRID GMBH & CO KG (Austria)
- ELES DOO SISTEMSKI OPERATER PRENOSNEGA ELEKTROENERGETSKEGA OMREZJA (Slovenia)
- KOLEKTOR SETUP, STORITVE ENERGETSKEGA UPRAVLJANJA, D.O.O. (Slovenia)
- COOPERATIVA ELECTRICA BENEFICA SAN FRANCISCO DE ASIS SOCIEDAD COOPERATIVA VALENCIANA (Spain)
- ELEKTRO PRIMORSKA, PODJETJE ZA DISTRIBUCIJO ELEKTRICNE ENERGIJE DD (Slovenia)
- TEKNOLOGIAN TUTKIMUSKESKUS VTT OY (Finland)
- EMOTION SRL (Italy)
- VOIMATEL OY (Finland)
- AVANT CAR D.O.O. ZA USLUGE I POSLOVNO SAVJETOVANJE (Croatia)
- ENGINEERING - INGEGNERIA INFORMATICA SPA (Italy)
- JOANNEUM RESEARCH FORSCHUNGSGESELLSCHAFT MBH (Austria)
- IDEAZ STORITVE DOO (Slovenia)
- ASM TERNI SPA (Italy)



Project Description

Context. The flexibility services – as offered by prosumers on LV level, to network operators on LV, MV and HV level and the local and wholesale market, are currently underutilised on a large-scale, and their unlocking via a dedicated ecosystem is needed to maximize their benefits in local, national and international power markets by way of optimizing security, reliability and cost-effectiveness of market operations on different levels. These services could enable the development of new business models and markets for different types and scales of flexibility services and to interact with various distributed resources in real-time, always using the resources that are technically and commercially the most attractive in a given moment.

Scope. A variety of benefits for both technical- and non-technical aspects of energy services supporting power market and grid operations will be created. Integration with power exchanges will be established. Presently, such services and business models don't exist in power markets, but there is a vast potential for them. STREAM covers their implementation, a true inclusion of various stakeholder groups on all levels of power market participation, from small-scale end-users, energy communities, ESCOs, service providers, to market- and system operators.

Technical description and implementation.

STREAM aims to develop an ecosystem comprised of 6 tools that represent the building blocks. It's important that the tools are modular and present functionalities that will be adopted by pilot site partners to fit their needs:

- sDATA – this tool will ensure secure and trusted data exchange from the flexibility assets to the management & aggregation platforms. It will facilitate data sharing and usage access control from end-users (flexibility assets) upstream to flexibility aggregators, DSOs and TSOs.
- SMART has two different designs:
 - SMART local market: central platform for flexibility trading activities, involving flexibility providers to aggregators and DSOs.
 - SMART peer-peer: tool aimed to orchestrate, coordinate and facilitate data assets versus service exchange, as well as financial and non-financial compensation.
- sGRID – this tool will provide DSOs with the ability to enhance their management of power network operational risks and challenges with the objective to ensure a safe and reliable long-term operation and low operational costs, by estimating the conditions on the

LV grid and pre-qualifying flexibility assets for active participation on a local energy market.

- sENC – this tool will empower energy community (EC) operators by providing information about the EC members (their energy and flexibility assets) and provide aggregation of total flexibility capacity, its management, and the offering of such flexibility in the local energy market.
- sPLAN – a robust decision support tool for the DSOs, policy makers and the NRAs. Complementing sGRID, it will enhance the decision-making processes of DSOs, comparing the value of conventional solutions (e.g. grid upgrades) and flexibility-based energy solutions.
- sFLEX – this tool will be STREAM's central flexibility management system, aimed towards medium- to large prosumers with large flexibility assets' capacity. sFLEX will provide them with valuable information for effective decision-making, and enable the aggregators to connect various devices into a large flexibility pool.

Impact. Replicability: The pilots are used for verification of replicability, scalability, and resilience of the solutions, ensuring product versatility and their interoperability through standardisation of the STREAM solutions. The tools and social innovations will be demonstrated in 4 European countries to examine replication potential in varied geographical, social, and economic contexts.

Socio-economics: In STREAM we will use the user-centric approach to explore new services that will increase comfort and flexibility of end-users, usage of the flexibility for different energy services bringing additional revenue streams (value stacking) and additional savings. Furthermore, the evaluation of STREAM solutions and their replication roadmap will consider financial aspects in TOTEX view (CAPEX + OPEX on a longer period to choose the best option), and broader benefits and externalities such as environmental and social impacts.

Environment: The EU's demand response potential is estimated to be up to 57 GW of small-scale flexibilities brought to markets by 2030. We estimate that the STREAM would help utilize 5% of this potential, which results in 2.85 GW in the long run. Currently the EU electricity generation CO₂ emission intensity is around 256 g CO₂/kWh, based on this the STREAM contribution to CO₂ savings would be around 6,4 mil. tons of CO₂ per year.

Policy: By developing innovative flexibility services for the established wholesale markets on the DSO and TSO level, we will help policy makers understand the need for new regulatory frameworks and policies.





**HORIZON-CL5-2021-D3-02-07: Reliability and resilience of the grid:
Measures for vulnerabilities, failures, risks and privacy**

[Back to projects' list](#)

eFORT

**Establishment of a FramewORk for
Transforming current EPES into a more resilient,
reliable and secure system all over its value
chain**



EUuniversal aims at implementing the Universal Market Enabling Interface (UMEI) concept by bringing forward a universal, open, adaptable and modular approach to interlink active system management with electricity markets and foster the provision of flexibility services, also acknowledging the activation needs and the coordination requirements with other commercial parties and TSOs. A set of market-oriented flexibility services from DERs will be implemented to answer DSOs' needs in a cost-effective way.

From 01/09/2022

**Project total
cost**

EU contribution

Website

To 31/08/2023

9.32 M€

7.99 M€

<https://efort-project.eu/>

Technologies and services deployed

Project partners' countries



Technologies for consumers



Grid technologies



Large-scale storage technologies



Distributed storage technologies



Generation technologies

Cybersecurity Management
Cyber Protection tools
Resilience utilities
Equipment Documentation Management
Embedded grid monitoring devices



Coordinator

**FUNDACION CIRCE CENTRO DE INVESTIGACION DE RECURSOS Y
CONSUMOS ENERGETICOS (Spain)**

Other partners:

- EUROPEAN NETWORK FOR CYBER SECURITY COOPERATIEF UA (NETHERLANDS)
- TENNET TSO BV (NETHERLANDS)
- NEDERLANDSE ORGANISATIE VOOR TOEGEPAST NATUURWETENSCHAPPELIJK ONDERZOEK TNO (NETHERLANDS)
- TECHNISCHE UNIVERSITEIT DELFT (NETHERLANDS)
- DNV NETHERLANDS BV (NETHERLANDS)
- RINA CONSULTING SPA (ITALY)
- DIGITALPLATFORMS S.P.A. (ITALY)
- EDYNA SRL (ITALY)
- FONDAZIONE LINKS - LEADING INNOVATION & KNOWLEDGE FOR SOCIETY (ITALY)
- FRAUNHOFER GESELLSCHAFT ZUR FORDERUNG DER ANGEWANDTEN FORSCHUNG EV (GERMANY)
- CUERVA ENERGIA SLU (SPAIN)
- SISTEMAS INFORMATICOS ABIERTOS SA (SPAIN)
- UNIVERSIDAD PONTIFICIA COMILLAS (SPAIN)
- SCHNEIDER ELECTRIC ESPANA SA (SPAIN)
- JOINT-STOCK COMPANY PRYKARPATTYAUBLENERGO (UKRAINE)
- ISOLUTIONS LLC (UKRAINE)
- UBITECH ENERGY (BELGIUM)
- SUITES DATA INTELLIGENCE SOLUTIONS LIMITED (CYPRUS)
- HYPERTECH KENTRO EPISTIMONIKON KAI TECHNOLOGIKON EREVNON AEIFORIAS ASTIKI MI KERDOSKOPIKI ETAIREIA (GREECE)
- ETHNIKO KENTRO EREVNAS KAI TECHNOLOGIKIS ANAPTYXIS (GREECE)
- B2B CONSULTING GROUP SL (SPAIN)
- SMART INNOVATION NORWAY AS (NORWAY)



Project Description

Context. Electrical Power and Energy Systems (EPES) are undergoing a transformation, from electromechanical systems to highly automated grids driven by smart devices and technologies with a wide variety of threats. These threats are reflected in the increase over the last two decades of blackouts (caused not only from climate related threats, but also from cybersecurity attacks). eFORT will provide a clear picture of the vulnerabilities and major threats and will put in place a set of solutions to address attacks and disruptive events and make European grids more secure and reliable.

Scope. eFORT's main scope is set into making European power grids more resilient and reliable to failures, cyberattacks, physical disturbances and data privacy issues.

To this end, a set of technological innovations will be developed for the detection, prevention and mitigation of risks and vulnerabilities with positive impacts on power system operation and stability. Additionally, it will:

- provide a deep understanding on the vulnerabilities and risks of the European power grid, both currently existing and arising ones, in its transition to a more digitalised and decentralised system.
- develop a robust EPES defence system composed of secure-by-design technologies capable of facing a wide range of potential threats in compliance with real-time requirements.
- develop a secure grid framework addressing privacy and data management issues.
- Develop operational technologies and strategies aiming at improving grid resilience.
- carry out a complete demonstration and validation program up to TRL 5-6 in four different demo-sites (Spain, Italy, Netherlands, and Ukraine).

Technical description and implementation. eFORT is built to create or improve different technologies to make EU EPES more reliable. The different developments are classified under the following categories:

- Enhanced tools for analysing EPES's risks and vulnerabilities: eFORT aims to identify the different risks that EPES may face (cyber and physical), and to create tools for their assessment.
- Measures and technologies to strengthen EPES' robustness: Technologies to protect EPES from islanding operations or interarea oscillations among others.
- More secure and private grid data management: By the creation of Data confidentiality procedures and data sharing methods and using innovative technologies as blockchain layers.
- Operational technologies and strategies for upgrading grid resilience: Insite technologies for the proper operation as an edge device for security management or an intelligent platform. Also, transversal measures, as the use of digital twins for the Control Room of the Future to train future grid operators.

All this work will be developed during the first 34 months of the project and validated during the last stage of the project in the different demonstrators.

Impact.

Replicability: eFORT will ensure the replication of the solutions firstly by demonstrating within the project the work done, and secondly, by considering during the overall project execution the potential customers that will adapt the technologies. Industrial partners are involved in the project to ensure a proper replication of the eFORT results.

Socio-economics: eFORT will also contribute to build talent to respond to the demand of industry for excellently trained experts in advanced grid operational technologies. Post-project upskilling activities are planned to further maximize the impact of the project and disseminate the enhanced knowledge that will be created. Thus, eFORT aims to improve the knowledge for the future grid operators.

Environment: eFORT contributes to the transition towards carbon-neutral energy framework through the deployment of several solutions easing the integration of the RES. By improving grid reliability, resiliency and security the potential contribution of more decentralized and intermittent RES will be increased.

Market Transformation: eFORT will create several tools. Successful validation of them will trigger market uptake of these solutions and enhance their international visibility, thus generating revenues and job growths. Additionally, a more resilient grid enables a more independent and renewable energy system promoting thus investments in the renewables deployment and decreasing the dependency of external energy sources.

Policy: eFORT outputs expect to impact on specific articles of the Directive (EU) 2019/944 (17.2, 17.5, 31 and 32) regarding the ownership and the operation of flexibility solutions by the market and regulated players and others regarding new regulatory environment for distribution system operators. eFORT also expects to impact on the revised Regulation 714/2009.





**HORIZON-CL5-2021-D3-02-07: Reliability and resilience of the grid:
Measures for vulnerabilities, failures, risks and privacy**

[Back to projects' list](#)







R²D²

**Reliability, Resilience and Defense technology
for the grid**



R²D² aims at improving the resilience and reliability of current Electrical Power and Energy Systems (EPES) against a growing number of threats and vulnerabilities.

From 1/10/2022	Project total cost	EU contribution	Website
To 30/09/2025	9.7 M€	7.3 M€	https://r2d2project.eu/

Technologies and services deployed	Project partners' countries
<p> Technologies for consumers</p> <p> Grid technologies</p> <p> Large-scale storage technologies</p> <p> Distributed storage technologies</p> <p> Generation technologies</p>	<p>Dynamic Risk assisment Contingencies analysis TSO-DSO interaction Cyber-security prevention tool Predictive maintenance</p> <p>Predictive maintenance for PV</p> 

Coordinator

ETRA I+D (Spain)

Other partners:

- S2 GRUPO (Spain)
- ELPROS (Slovenia)
- GUARDTIME OU (Estonia)
- CYBER NOESIS IKE (Greece)
- INSTITUTE OF COMMUNICATION AND COMPUTER SYSTEMS - ICCS (Greece)
- SS. CYRIL AND METHODIUS UNIVERSITY IN SKOPJE (North Macedonia)
- SECURITY COORDINATION CENTRE SCC LTD BELGRADE (Serbia)
- EMS SERVICES DOO (Serbia)
- DIACHEIRISTIS ELLINIKOU DIKTYOU DIANOMIS ELEKTRIKIS ENERGEIAS AE - HEDNO (Greece)
- ELEKTRO LJUBLJANA (Slovenia)
- ELEKTRO LJUBLJANA OVE (Slovenia)
- EDP NEW (Portugal) (Country)
- EDP SPAIN (Spain)
- INSTITUT MIHAJLO PUPIN (Serbia)
- UNIVERSITY OF CYPRUS (Cyprus)
- RTE INTERNATIONAL (France)
- IMPERIAL COLLEGE OF SCIENCE TECHNOLOGY AND MEDICINE (United Kingdom)



Project Description

Context. Nowadays Electrical Power and Energy Systems (EPES) have many vulnerabilities due to technical factors (faults, voltage and frequency fluctuations, intermittent generation, etc.) or human factors (operational errors, accidental events, or malicious behaviours). Extreme weather events are becoming progressively more frequent, even in areas where in the past they used to occur very rarely. The magnitude and recurrence of blackouts due to extreme weather events and consequent severe damages to people and the economy is already a weak point of the electrical infrastructures. Moreover, a wide range of new risks related to cybersecurity and cyber threats can exploit to gain access to critical infrastructure.

Scope. Through the demonstration and integration of the innovative solutions provided by R2D2, it will be possible to achieve a more secure, reliable, and resilient energy system in Europe, making a positive and tangible impact throughout the European EPES value chain. Project's scope includes the security of power system operation embracing the whole chain from the regional coordination between TSOs, to privacy of LV customers.

Technical description and implementation. The project is built on top of strong energy coordination actions in Southern Europe, following EU legislation and in alignment with the recent activities promoted by ENTSO-E about cyber-security in transmission systems.

R2D2 will deliver complementary solutions synthesised into four products dedicated to the prevention, protection, and restoration of EPES:

P1. Multi-risk assessment framework for power system (short name: C3PO) contributes to a systematic, disciplined, and repeatable approach for evaluating an energy system security strategy.

-Beneficiaries: System Operators.

P2. Resilience suite for TSO & DSO (short name: IRIS) intervenes when coordination between system operators is needed for security reasons, including possible adoption of distributed resources for emergency situations.

-Beneficiaries: System Operators and Regional Security and Coordination Centres.

P3. Prevention Systems for Energy Infrastructures Security (short name: PRECOG) provides a cybersecurity framework to OT and IT, through advanced techniques for threats detection and event management.

- Beneficiaries: System Operators, IT consultants, electric industries, and manufacturers.

P4. Enhanced Assets Maintenance and Management Toolkit (short name: EMMA) contributes to the reliability of the physical assets and to a fast grid recovery through robotic and automated technologies.

- Beneficiaries: System operators, contractors, electric industries, and manufacturers.

Impact. *Replicability:* R2D2 results will be tested and validated in 4 large-scale complementary demonstrators in Greece, Serbia, Spain, and Slovenia involving

representative and complete value chains, a wide variety of energy sources, networks, systems, and assets, and spanning heterogeneous climatic, geographic, and socioeconomic conditions which will facilitate replicability, scale-up and eventual market launch.

Socio-economics: Thanks to a smart, efficient end-to-end monitoring and control of power networks, EPES benefit from an overall system costs reduction coming from reduced power losses, lower number and duration of outages and lower investment in disaster recovery. Final customers will benefit of a power supply with higher standards of provision's security and availability and reducing the average restoration time -after a critical event.

Environment: R2D2 is contributing to achieve a more resilient and reliable EPES, reducing the number and the magnitude of the outages and of the stress conditions typically originated by RES (overvoltage, etc.), enabling a full exploitation of distributed resources to mitigate critical events.

Market Transformation: The adoption of R2D2 solutions will impact the electricity industry allowing a closer interaction among system operators in new emergency scenarios. Furthermore, the validation of robotic and automated solutions in real-life conditions, will enable the adoption of advanced technologies not only in high voltage systems, but also in medium and low voltage networks.

Policy: Through the standardisation and recommendations activities R2D2 is promoting the adoption of the methodology and technologies developed in the project, contributing to the realization of EU short- and mid-term policy objectives (2030) and the transition towards a decarbonised energy system.



Product 1:
C3PO



Product 2:
IRIS



Product 3:
PRECOG



Product 4:
EMMA



HORIZON-CL5-2021-D3-02-08: Electricity system reliability and resilience by design: High-Voltage, Direct Current (HVDC)-based systems and solutions

[Back to projects' list](#)

HVDC-WISE

HVDC-based grid architectures for reliable and resilient WideSprEad hybrid AC/DC transmission systems



HVDC-Wise project explores concepts and proposes solutions to foster the development of large HVDC based transmission grid infrastructures, able to bring benefits in terms of resilience and reliability to the existing electrical system and capable of integrating the forthcoming large amount of renewable energy.

From Oct 2022	Project total cost	EU contribution	Website
To 31/03/2026	8.3 M€	6.6 M€	https://hvdc-wise.eu/

Technologies and services deployed Project partners' countries



Technologies for consumers



Grid technologies



Large-scale storage technologies



Distributed storage technologies



Generation technologies

HVDC
HVAC
Multi terminal
Protections
Network management tools
HVDC Breaker
Inertia



Coordinator SuperGrid Institute (France)

Other EU partners:

- TENNET TSO GMBH (GERMANY)
- UNIVERSIDAD PONTIFICIA COMILLAS (SPAIN)
- RHEINISCH-WESTFAELISCHE TECHNISCHE HOCHSCHULE AACHEN (GERMANY)
- EPRI EUROPE DAC (IRELAND)
- TECHNISCHE UNIVERSITEIT DELFT (NETHERLANDS)
- ENGIE IMPACT BELGIUM (BELGIUM)
- UNIVERSITY OF CYPRUS (CYPRUS)
- RICERCA SUL SISTEMA ENERGETICO - RSE SPA (ITALY)
- ENERGINET (DENMARK)
- AMPRION GMBH (GERMANY)
- STATNETT SF (NORWAY)

Associated Partners:

- UNIVERSITY OF STRATHCLYDE (UNITED KINGDOM)
- SCOTTISH HYDRO ELECTRIC TRANSMISSION PLC (UNITED KINGDOM)



Project Description

Context. Electricity transmission systems are undergoing major changes, including the increasing integration of power electronics and the de-commissioning of conventional power plants. To face the challenges related to this evolution, the reinforcement of the transmission system is necessary. High Voltage Direct Current (HVDC) systems appear to be one of the most suitable technologies to perform this upgrading of the transmission system.

Scope. In this context, the HVDC-WISE project aims to leverage the full potential of HVDC to enhance the resilience and reliability (R&R) of overall transmission systems via their effective planning and operation. With this aim in mind, the project overall objective is to propose, analyse, design, and validate what we refer to as “HVDC-based grid architecture concepts” enabling the deployment of reliable and resilient AC/DC transmission grids to achieve the European energy transition. In the project, an HVDC-based grid architecture concept is defined as the combination of:

- the topology of the reinforcing infrastructure,
- its technological components,
- operation algorithms for control and protection, and
- its deployment plan specifying how to build such grid in a stepwise manner.

In other words, an HVDC-based grid architecture is a set of technological solutions that seek to strengthen the existing network to meet future system needs using HVDC transmission.

Technical description and implementation.

To reach the project objective, our methodology is based on the following main activities:

- Development of a complete reliability-&-resilience-oriented planning toolset. This toolset comprises methodologies and tools for expansion planning accounting for the reliability and resilience challenges faced by networks integrating high shares of HVDC technologies and power electronics. As part of the toolset, a library of standardized models of HVDC technologies, compatible with the proposed tools, will be developed.
- Proposition and assessment of HVDC-based grid architecture concepts. The aim is to understand the risks and benefits of HVDC grids on overall system R&R. Innovative control and protection functionalities will be proposed for the different HVDC architectures to reduce their associated risks and maximize their participation on supporting the grid.
- Identification, modelling, and assessment of emerging technologies for building the HVDC-based grid architectures.
- Validation of the resilience-oriented planning toolset and of the HVDC-based grid architecture concepts in an industrially relevant environment. To ensure that these solutions are relevant to the European TSOs, they will be validated on three realistic use cases,

representing different regions of Europe, each one with specific challenges.

Impact. Replicability: The study of three different realistic use cases at different levels of detail will allow to cover different contexts of power systems in Europe (in terms of complexity, share of renewables, regulatory frameworks, etc). Moreover, the propositions to include HVDC systems in industrial grid data standards will ease the task of TSOs to include project results in different industrial tools.

Socio-economics: HVDC-WISE will identify emerging technologies needed for the integration of clean energy into the power system via HVDC systems. This will strongly favour the opening of new business horizons for European companies in the global clean energy market.

Environment: The decarbonization of the energy sector will not be possible without upgrading the transmission system. HVDC-WISE will propose solutions to perform this upgrade in a cost-effective manner and considering the potential threats in the system.

Market Transformation: In the final phase of the project, a technology roadmap will be proposed. Its aim is to guide technology providers towards market opportunities that enables resilient hybrid AC/DC systems and to guide planners and developers on timescales associated with new technologies.

Policy: The HVDC-WISE results are expected to help set the guidelines for explicitly considering resilience in the future policy and regulatory frameworks, hence enabling the systematic investment decisions in traditional cost-benefit analysis for HVDC interconnections, while quantifying and justifying their role in cascading mitigation.





HORIZON-CL5-2021-D3-02-08: Electricity system reliability and resilience by design: High-Voltage, Direct Current (HVDC)-based systems and solutions

[Back to projects' list](#)

NEWGEN

New generation of HVDC insulation materials, cables and systems

NEWGEN

The overall objective of the project NEWGEN is to develop and demonstrate new insulation materials, cable manufacturing solutions, online condition monitoring technologies, and comprehensive life and reliability modelling tools for next-generation of extruded high voltage direct current (HVDC) cables and cable systems, thereby fostering the reliability and resilience of the inter-connected European HVAC/-DC transmission grids.

From 01/10/2022

Project total cost

EU contribution

Website

To 30/09/2026

7.6 M€

7.6 M€

<https://www.newgen-project.eu/>

Technologies and services deployed

Project partners' countries



Technologies for consumers



Grid technologies

HVDC
Network management monitoring & control tools



Large-scale storage technologies



Distributed storage technologies



Generation technologies



Coordinator

TEKNOLOGIAN TUTKIMUSKESKUS VTT OY (VTT)

Other partners:

- ALMA MATER STUDIORUM - UNIVERSITA DI BOLOGNA (Italy)
- MAILLEFER EXTRUSION OY (Finland)
- TECHIMP - ALTANOVA GROUP SRL Italy)
- UNIVERSITEIT TWENTE (Netherlands)
- TAMPEREEN KORKEAKOULUSAATIO SR (Finland)
- GREENDELTA GMBH (Germany)
- SUPERGRID INSTITUTE (France)
- CLIC INNOVATION OY (Finland)
- TERNA RETE ITALIA SPA (Italy)



Project Description

Context

HVDC underground and submarine cables constitute an essential technology for the long-distance transmission of electrical power with minimal losses, thereby enabling European decarbonization and reaching climate neutrality by 2050 in accordance with the European Green Deal. Increased physical interconnections via HVDC cable links across Europe will facilitate the grid-integration of renewable energy sources (RES) to provide clean energy, create a more competitive European transmission system, and reduce electricity prices for consumers and businesses. Extruded HVDC cables with cross-linked polyethylene (XLPE), and more recently also thermoplastic polypropylene (PP)-based insulation, represent a new generation of HVDC cables, offering several benefits over conventional mass impregnated (MI) HV cables such as mechanical robustness, easier installation due to less complex jointing, lower weight and lower price, thus making them a very compelling new alternative especially for on-shore applications typically up to ± 320 kV with a capacity of 800–1,000 MW nowadays.

Scope

The overall objective of NEWGEN is to develop and demonstrate new insulation materials, cable manufacturing solutions, online condition monitoring technologies, and comprehensive life and reliability modelling tools for the next-generation of extruded HVDC cables and cable systems, thereby fostering the reliability and resilience of the inter-connected European HVAC/-DC transmission grids. NEWGEN delivers new space charge mitigating additives for extruded HVDC insulation materials, as well as new industrial cable extrusion solutions for defect-free and cost-effective manufacturing of next generation thermoplastic HVDC cables. Moreover, NEWGEN will provide online global condition monitoring and novel pre-fault detection methods and instruments for assessing the health status of extruded HVDC cable systems, as well as comprehensive tools and models for the evaluation of life and reliability of extruded HVDC cable systems (cable, joints and terminations) under realistic operation conditions within HVAC/-DC grids (model demonstration via grid-simulations).

Technical description and implementation

WP1 – Space charge mitigation in polymeric HVDC cable insulation Development of novel chemical additives for mitigating space charge accumulation in polymeric HVDC cable insulation materials, and evaluation of their sustainability and up-scaling potential. Demonstration of the space charge mitigation in novel pilot-scale HVDC insulation compounds and providing material samples and extensive characterization data for life and reliability modelling. Optimization of novel PP- and XLPE-based HVDC insulation compounds for cable extrusion, and manufacturing of large compound batches for mini-cable and HVDC prototype cable extrusion trials in WP2.

WP2 – Reliable-by-design manufacturing of HVDC cables Development of cable manufacturing equipment and extrusion process control aiming towards defect-free thermoplastic cables. Pilot-scale demonstration of life-size HVDC cable prototypes with novel insulation formulations. Production of cable model “A” samples (as per Cigré 636) with novel insulation formulations for electrical testing and characterization.

WP3 – Novel pre-fault monitoring solutions for HVDC cables and accessories Optimization of acquisition techniques under HVDC for diagnostics parameters derived from HVAC. Development of a fault location device based on the time-of-flight of partial discharges. Development of an online monitoring device for leakage currents. Prototype of global online monitoring system for HVDC cables. Development of single/multi parameters diagnostics techniques.

WP4 – Tools and models for reliable and resilient HVDC cable systems. Development and validation of a life and reliability model for HVDC cable systems consisting of cables, joints and terminations. Development of a design optimization procedure for HVDC cables. Establishment of a relationship between pre-fault monitoring data and cable system life model. Evaluation of the impact of HVDC cable systems on the overall transmission system reliability, with the HVDC cable link acting as a “firewall” within the synchronous AC transmission system. Evaluation of the effects and resilience to faults of the HVDC cable connection in the AC network, by modelling and quantifying the impact on system reliability of an increasing number of HVDC links.

WP5 – Communication, Dissemination and Exploitation Disseminating results to identified target groups. Enhancing synergies through clustering with relevant projects and networks. Assessing the patent landscape, defining and implementing the IPR strategy. Identifying and managing the key exploitable results to ensure effective exploitation.

WP6 – Project Management and Coordination Overall management, administration, coordination and execution of the project, and that the project progresses and results are achieved in accordance with the Grant Agreement (GA) and expectations of the call.

Impact

While extruded HVDC cables will be a key technology moving into the future, expanding their utilization to higher power transmission capacity and ensuring their reliable operation over the expected lifetime of up to 40 years still requires new technological innovations. The reliability of the HVDC cables and systems is crucial for the reliability and resilience of the whole transmission grid, to ensure satisfactory firewall properties against disturbances in the hybrid AC/DC network, and to foster the massive integration of remote renewables into the grid.



HORIZON-CL5-2021-D3-02-09: Demonstration of superconducting systems and elpipes

[Back to projects' list](#)

SCARLET

Superconducting cables for sustainable energy transition



SCARLET will develop and demonstrate superconducting cable systems at the gigawatt level, including offshore superconducting links, long-length onshore superconducting cables, and hydrogen-cooled superconducting cables.

From 2022	Project total cost	EU contribution	Website
To 2027	19.60 M€	14.99 M€	www.scarlet-project.eu

Technologies and services deployed	Project partners' countries
<p> Technologies for consumers</p> <p> Grid technologies</p> <p> Large-scale storage technologies</p> <p> Distributed storage technologies</p> <p> Generation technologies</p>	<p>Superconducting cables Offshore links Transmission grid Distribution grid Grid protection</p>

Coordinator **SINTEF ENERGI AS (Norway)**

Other partners:

- INSTITUTE FOR ADVANCED SUSTAINABILITY STUDIES EV (Germany)
- WAVEC/OFFSHORE RENEWABLES - CENTRO DE ENERGIA OFFSHORE ASSOCIACAO (Portugal)
- INSTITUTE OF ELECTRICAL ENGINEERING, SLOVAK ACADEMY OF SCIENCES (Slovakia)
- ALMA MATER STUDIORUM - UNIVERSITA DI BOLOGNA (Italy)
- ABSOLUT SYSTEM SAS (France)
- ECOLE SUPERIEURE DE PHYSIQUE ET DECHIMIE INDUSTRIELLES DE LA VILLE DE PARIS (France)
- SUPERGRID INSTITUTE (France)
- RICERCA SUL SISTEMA ENERGETICO - RSE SPA (Italy)
- RINA CONSULTING SPA (Italy)
- SUPERNODE LIMITED (Ireland)
- VISION ELECTRIC SUPER CONDUCTORS GMBH (Germany)
- ASG SUPERCONDUCTORS SPA (Italy)
- NEXANS FRANCE (France)
- NEXANS DEUTSCHLAND GMBH (Germany)



Project Description

Context. The promise of superconducting cables lies in their high efficiency, compact size, and reduced environmental impact, which could help to overcome challenges posed by overhead lines and conventional cables. SCARLET will develop and industrially manufacture superconducting cable systems at the gigawatt level, bringing them to the last qualification step before a commercial installation. SCARLET will investigate the whole range of effects of superconducting cables, as their properties open the door for cost savings beyond the cables themselves.

Scope. The key objectives of SCARLET are:

- Development, industrial manufacturing, type test, and demonstration of full-scale high-temperature superconducting cables cooled with liquid nitrogen for a bipolar 1 GW link (± 50 kV/10 kA)
- Design of offshore superconducting links cooled with liquid nitrogen for bipolar 1 GW power transfer (± 50 kV/10 kA)
- Development, industrial manufacturing, type test, and demonstration of full-scale MgB₂-based superconducting cables cooled with liquid hydrogen for a bipolar 1 GW link (± 25 kV/20 kA)
- Simulation of comprehensive electric system use cases, their protection requirements, and design and demonstration of a protecting fault current limiter module able to handle a nominal current of 10 kADC.

Technical description and implementation. All SCARLET technologies are designed for medium-voltage direct-current (MVDC) operation, enabled by the high-current capability of superconductors, which eliminates costly high-voltage converter stations and allows for significant overall cost reductions.

- Each of the main demonstration areas described above has its dedicated WP, which together constitute the technological core of the project. Additionally, there is a WP focussed on economic evaluations and in-field integration studies. This WP also contains the studies of el pipe systems.
- These 5 WPs are completed by a WP dedicated to dissemination, exploitation, and standardisation, and a last WP responsible for the project coordination.

Impact.

Replicability: The superconducting cable systems to be developed and demonstrated will be ready for immediate scale-up for follow-up full-scale installations, and a further scale-up to meet new market demands.

Socio-economics: Techno-economic assessments will be performed for all technologies under consideration in SCARLET, to confirm their beneficial application areas and advance their exploitation paths. In the comparison between superconducting and conventional cable systems, a holistic approach will be applied considering, in addition to the cables themselves, the benefit of operation at lower voltages offered by superconductivity.

Environment: Superconducting cables offer the benefit of a reduced environmental footprint compared to conventional resistive cables. As they can transport tens of kiloamperes in a very compact single conductor, they can easily overcome the ampacity and space limitations of resistive MVDC cables. Moreover, as superconducting cables strictly operate at the design temperature regardless of the soil conditions, there is no risk of thermal runaway (and soil degradation) as for conventional cables and hence, no derating of the transmitted power is needed at high ambient temperatures (e.g., during summer).

Market Transformation: SCARLET contributes to a more sustainable energy market, enabling the delivery of fossil-free energy at an affordable costs.





HORIZON-CL5-2021-D3-02-10 - Demonstration of advanced Power Electronics for application in the energy sector

[Back to projects' list](#)

AdvanSiC







Advances in Cost-Effective HV SiC Power Devices for Europe's Medium Voltage Grids



The objective of AdvanSiC is to develop, produce, test, and validate cost-effective High-Voltage (HV) Silicon Carbide (SiC) MOSFET semiconductors in MVDC grid applications, a full-scale wind converter, a full-scale solar inverter, and a solid-state circuit breaker for DC converter stations.

The aim is to minimize HV SiC device cost by advancing novel design structures and process optimization. Beyond this, we shall assure an immune and reliable environment to handle SiC fast transients, as well as optimize passives and cooling system to provide cost reduction not only at device level but also at system level.

From Jan 2023	Project total cost	EU contribution	Website
To Dec 2025	4.0 M€	3.24 M€	https://www.advansic-euproject.eu

Technologies and services deployed	Project partners' countries
 Technologies for consumers  Grid technologies HVDC Breaker  Large-scale storage technologies  Distributed storage technologies  Generation technologies Wind power PV	

Coordinator	IKERLAN (SPAIN)
--------------------	------------------------

Other partners:

- MERSEN FRANCE ANGERS SAS (France)
- CONSIGLIO NAZIONALE DELLE RICERCHE (Italy)
- L.P.E. SPA (Italy)
- GAMESA ELECTRIC SOCIEDAD ANONIMA (Spain)
- UNIVERSITA DEGLI STUDI DI NAPOLI FEDERICO II (Italy)
- DEEP CONCEPT (France)
- ABB SPA (Italy)
- mqSemi AG (Switzerland)
- THE UNIVERSITY OF WARWICK (United Kingdom)
- THE UNIVERSITY OF NOTTINGHAM (United Kingdom)



Project Description

Context. Converter stations use power electronics technology to convert AC to DC voltage and vice versa. They integrate renewables and interconnect grids. Besides, Medium Voltage DC (MVDC) power systems require the extensive use of power electronics to connect power sources and loads to the MVDC bus and to provide system protection. Silicon (Si) IGBTs dominate the MVDC scenario, from converter stations to converters for renewable and storage systems. However, for a larger deployment of clean and sustainable energies more efficient and competitive converter solutions are necessary. In this framework, Wide Bandgap (WBG) technology provides several benefits compared to conventional silicon technology:

- 10x higher dielectric breakdown field strength, which results in thinner device layer thicknesses, reducing consequently electrical and thermal resistance and hence the power losses of the device.
- 2x higher electron saturation velocity, which enables higher switching speeds.
- 3x higher thermal conductivity, which enables lower operating temperature and thermal stress.

Scope. Two major issues are slowing down the adoption of high voltage SiC power semiconductors. The first is related to the high cost of >1.2kV SiC technology due to the costs of epitaxy, and yield issues as the die sizes increase. The second issue is the relative market size for HV power semiconductors, which is small compared to the dominant automotive market, which means that the few large IDMs producing SiC devices are not prioritising their development. Hence, there is a lack of supply, generally, as well as a lack of second source suppliers. AdvanSiC aims to tackle both issues, by first demonstrating the large cost savings realisable by optimising the device processes, and second by demonstrating the benefits that HV SiC devices will deliver to real world use cases, so demonstrating the potential market.

Moreover, the high chip costs are not likely to be offset by cost reductions at the system level. Particularly in grid applications, the size and weight of the system, which is largely dominated by the cooling infrastructure and passive components, are not critical as they are in automotive applications for instance. However, system efficiency is a key differentiating characteristic enabled by SiC semiconductors, one that will reduce LCoE (Levelized Cost of Energy) and help in advancing the deployment of semiconductor technology.

Technical description and implementation. To reduce the cost of HV SiC semiconductors with outstanding technical characteristics, AdvanSiC will tackle different stages of the supply chain until the power module is available for the demonstrators; from the epitaxy to the design of planar MOSFETs and semi-super junction technology, to optimized high-voltage power modules. All done by EU

SMEs and start-ups, therefore keeping advances, knowhow, and intellectual property within EU of this key and emerging technology. The following specific objectives will be tackled within the project:

- Reduce the overall cost of the epitaxy.
- Design a 3.3 kV SiC MOSFET chip with high performance and reduced costs.
- Optimize HV power module development process.
- Assure a reduced size, immune and reliable HV SiC based power stack.
- Demonstrate the benefits of HV SiC MOSFETs in full-scale laboratory prototypes.
- Quantify the techno-economic benefits of HV SiC MOSFETs in grid applications.
- Create awareness of AdvanSiC results to minimize replication barriers across industry.

Impact. Replicability: The main research outcome of the project will be a new HV SiC MOSFET semiconductor, manufactured through an improved cost-effective process. In the short term, this new technology will be validated in three use cases, in three different applications, wind and solar power generation and a solid-state circuit breaker. However, this technology will be put at disposal of power electronics community and its various applications in the medium term.

Environment: By enabling a cost reduction of windmills and PV plants, and by easing the integration of renewable generation in MVDC grids, the implementation of the AdvanSiC solution will contribute to increase the penetration of renewable generation and battery energy storage and to cut CO2 emissions. Additional emissions reduction will result from the improved conversion efficiency.

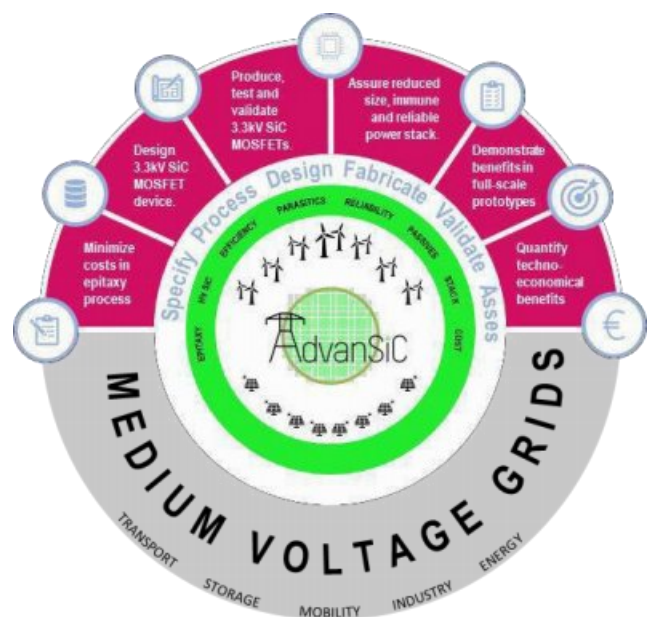



HORIZON-CL5-2021-D3-02-10 - Demonstration of advanced Power Electronics for application in the energy sector

[Back to projects' list](#)

FOR2ENSICS

Future Oriented Renewable and Reliable Energy SiC Solutions



Efforts to transition towards greener renewable energy sources to mitigate climate change have caused numerous disruptions to the unprepared electric grid. These efforts have also made it hard to adapt to these new energy sources and electric vehicle (EV) recharging infrastructure. DC charging infrastructure offers a possible solution for accommodating these new energy sources. However, it would demand the use of efficient, low cost and compact DC/DC converters for LV to MV, which are not currently available. The EU-funded FOR2ENSICS project proposes to develop these converters by utilising ultra-high voltage switching devices based on silicon carbide (SiC) and by developing and utilising low-cost, high-efficiency production processes.

From 01/01/2023	Project total cost	EU contribution	Website
To 31/12/2026	5 533 9100 M€	4 393 517M€	TBD

Technologies and services deployed



Technologies for consumers

for Demand response
Smart appliances
HVDC



Grid technologies



Large-scale storage technologies



Distributed technologies

storage

Development of HV 4H-SiC devices and modules for MVDC and DC/DC applications



Generation technologies

Project partners' countries



Coordinator: CSIC (Spain)

Other partners:

- II-VI KISTA AB(Sweden)
- UNIVERSITAET BREMEN (Germany)
- DEEP CONCEPT (France)
- SUPERGRID INSTITUTE (France)
- Hitachi ABB Power Grids Ltd.(Switzerland)
- ECOLE POLYTECHNIQUE FEDERALE DE LAUSANNE (Switzerland)
- THE CHANCELLOR MASTERS AND SCHOLARS OF
- THE UNIVERSITY OF CAMBRIDGE (United Kingdom)



Project Description

Context. Driven by the continued effort to combat the climate change and achieve carbon neutrality, the composition of the energy sources and consumers connected to the electrical grid is rapidly changing. An increasing amount of issues are being experienced by distribution system operators while trying to accommodate new systems like renewable energy sources or electric vehicles charging infrastructure. One of the possible solutions is to develop a DC distribution infrastructure, which is especially interesting as most of the new connections mentioned above are native DC sources and loads, respectively. For this purpose, the project aims at the design, fabrication and testing of 15 kV SiC IGBT modules.

- Commercial DC/DC converter
- Cost and environmental impact reduction of the fabrication processes.

Scope. The aim of this project is to develop and demonstrate a commercial DC/DC converter prototype which can be introduced to the market within short timescale (<3 years) after completion of the project. To achieve such an ambitious target, the project team has decided to focus on the development of ultra- high voltage (UHV) SiC based switching devices which would allow a remarkable simplification of the converter topology as well as a very compact design when coupled with high frequency operation.

- Deliver innovative, cost-effective and highly efficient grid power converter systems
- Ultra-high voltage (UHV) SiC based switching devices
- Understand reliability issues.

Technical description and implementation.

The project is divided into six scientific work packages (WPs), complemented by two transversal WPs dedicated to coordination (WP7) and exploitation/dissemination (WP8). The main objective is to provide UHV SiC materials and devices with disruptive performances which will in future enable implementation of:

- Power electronics systems with higher efficiency, lower volume and weight, smaller and cheaper cooling solutions and longer product lifetime;
- Reduced power device losses, consequently resulting in energy saving and reduction of carbon emission;
- Novel system topologies and applications benefiting from availability of UHV (15kV) devices;
- Higher reliability due to reduced number of components, higher efficiency and easier cooling for strong power cycling conditions and operation in harsh environments.

Impact. *Replicability:* FOR²RENSICS proposes a very innovative “n+ substrate splitting” fabrication method, the handling of relatively thin SiC wafers inside a 6” semiconductor fab will offer key information in terms of the suitability of such wafers to be safely and reproducibly processed in the fabrication.

Socio-economics: This project aims to produce cost-effective power electronics building blocks (PEBBs), meeting the techno-socio-economic and environmental targets that would enable industrial deployment of ultrahigh voltage SiC technology. In this regard one of the successful criteria would be completion of the MVDC converter test programme and achievement of the TRL5 for the converter and TRL6 for the device.

Environment: FOR²RENSICS will optimize certain process steps which are very time and energy consuming, impacting production throughput and economical and environment costs. Overall, We estimate that a 30% energy and a 15% water consumption reduction is possible in a next generation of SiC VDMOS/IGBT process technology.

Market Transformation: Energy system developers, distribution system operators, policy makers and to some degree OEM manufactures would be able to use results of FOR²RENSICS project to consider new efficient approaches to build power distribution infrastructure. Results of the extensive reliability investigation of different system components undertaken would be of particular interest to engineering and academic community. These results will underline further fundamental development to support industrialisation of the technology and provide new design practices to be applied with new technologies such as medium frequency medium voltage operation of power electronic components (medium frequency transformers, isolation components, high voltage packaging).

Policy: several fields of the scientific community will be impacted: power electronics, applied physics and semiconductor power devices. The intertwining of the requirements between the different disciplines will also provide a wider dimension to all their members



HORIZON-CL5-2021-D3-02-10: Demonstration of advanced Power Electronics for application in the energy sector

[Back to projects' list](#)







SiC4GRID

Next Generation Modular SiC-Based Advanced Power Electronics Converters for Enhanced Renewables Integration into the Grid



SiC4GRID is a 42-months project gathering partners from the complete value chain of SiC-based converters collaborating to tackle current obstacles to the technologies' market uptake.

From 2022	Project total cost	EU contribution	Website
To 31/03/2026	4.6 M€	3.7 M€	http://www.sic4grid.eu/

Technologies and services deployed		Project partners' countries
	Technologies for consumers	
	Grid technologies	
	Large-scale storage technologies	
	Distributed storage technologies	
	Generation technologies	
	HVDC HVAC	
	Batteries	
	Wind turbine PV	

Coordinator

VRIJE UNIVERSITEIT BRUSSEL (Belgium)

Other partners:

- AALBORG UNIVERSITET (Denmark)
- ELECTRICITE DE FRANCE (France)
- SOITEC SA (France)
- POWERCON AS (Denmark)
- KK WIND SOLUTIONS AS (Denmark)
- INFORMATION TECHNOLOGY FOR MARKET LEADERSHIP (Greece)
- MONDRAGON GOI ESKOLA POLITEKNIKOA JOSE MARIA ARIZMENDIARRIETA S COOP (Spain)
- EUROQUALITY SARL (France)
- Hitachi ABB Power Grids Ltd (Switzerland)
- CSEM CENTRE SUISSE D'ELECTRONIQUE ET DE MICROTECHNIQUE SA - RECHERCHE ET DEVELOPPEMENT (Switzerland)
- AMANTYS POWER ELECTRONICS LTD (United-Kingdom)



Project Description

Context. While renewable energy technologies are taking an increasing share of the energy mix in most of the world countries and Europe in particular, their development are hindered by different factors in particular efficiency, intermittency, power curtailment, capability, flexibility but also cost and environmental impact. To ensure the continued viability and uptake of renewable energy technologies, innovations in these fields are thus necessary. power electronics (PE) systems' efficiency, dynamic performance and reliability can be greatly improved using wide bandgap (WBG) electronics and Silicon Carbide (SiC) in particular. WBG semiconductors foster strong saving in fields such as e-mobility, data centres, intelligent buildings and smart grids and renewables.

Scope. It is in this context that SiC4GRID is deployed to tackle a specific aspect of power electronics: the use of WBG semiconductors in converter stations for energy- and cost-efficient onshore and offshore energy production. SiC4GRID will contribute mainly to the reduction of technology cost and environmental impact by enhancing PE continuous evolution in the midst of renewable energy technologies' optimisation for a wider deployment and implementation throughout Europe and beyond. In this field, SiC have already been identified as a promising WBG switching semiconductor for converter station applications but their high costs affect the overall power plant cost and impacting its uptake and integration in the grid. During the project, innovative converters will be developed and tested as meeting technoeconomic as well as environmental feasibility criteria. SiC4GRID will also focus on the evolution from a strict physical infrastructure technology and include data, flexibility and reliability as a core part of its development.

Technical description and implementation. The following innovations are driving the main activities in SiC4GRID, also shown in the figure:

- INNO 1 – Innovative SiC switches with novel EPI wafers structure for 3.3kV applications
- INNO 2 – Low-cost 3.3kV SiC-based modules with smart gate drivers
- INNO 3 – Co-design optimisation tool with design for high replicability and reliability (D4HR)
- INNO 4 – Digital Twin modelling for use case applications
- INNO 5 – Smart IoT architecture enabling self-healing EMS
- INNO 6 – Comprehensive circularity and environmental sustainability of SiC4GRID technology innovations

Impact. Replicability: SiC4GRID promotes the use of SiC based components, also developing a production line for SiC wafers to make sure that the production capacity can cover the effective market needs. These needs will be considered with different physical and virtual use cases, considering typical HVDC/MVDC applications in Europe.

Socio-economics: SiC4GRID is focusing on the commercial and market uptake potential of SiC-based converters, ensuring that socially, environmentally, economically and technologically all parameters are set for a strong uptake of a cost-effective, de-risked, grid integrated, sustainable technology throughout the value chain, thanks to all actors of this chain behind represented in the consortium. This aims at providing sustainable renewable energy technologies in terms of techno-economic and environmental assessment, all the while integrating the social acceptance dimension, especially of onshore/offshore wind energy.

Environment: The SiC-based converters eco-design strategies are targeting the long-term goal to provide environment-friendly suggestions towards converter size reduction without increasing the stress on materials and resources. This is in line with the European Green Deal priorities of minimising resource consumption, replacing critical materials with more sustainable choices and favouring material recovery after technological end-of-use.

Market Transformation: The use of high efficiency SiC based converters is also limited at present by the lack of markets for medium voltage/medium power DC applications, such as MVDC inter-array systems. However, through increasing the R&I-based validation and large-scale demonstration of these solutions for several applications, the situation can change in the medium-term especially as the increase of the size and power of renewable farms will make the need for SiC based converters more important and attractive. That is why, the SiC4GRID consortium gathers important actors covering the complete value chain and ensuring the knowledge and impact on the market.

Policy: SiC4GRID is aiming at providing an impactful close-to-market solution with a strong impact on all target groups including policy- and decision-makers able to push regulations for sustainable renewable energy technologies. In particular, through its learnings the project will provide clear guidelines in terms of regulations for the market uptake of the developed solutions, aiming at net zero greenhouse gas emissions by 2050.

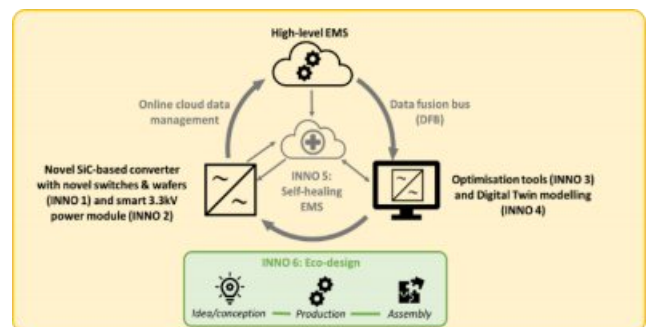



HORIZON-CL5-2021-D3-02-11: Reinforcing digitalisation related know how of local energy ecosystems

[Back to projects' list](#)







EVERY1

Enable eVeryone's Engagement in the eneRgY transition



The Every1 consortium brings together leading experts in energy, education, and ecosystems combined with social sciences to deliver an impactful concept that includes all elements needed to enable the effective participation of all European stakeholders in the digital energy market.

From 2022	Project total cost	EU contribution	Website
To 2026	3.2 M€	3.2 M€	www.every1.energy

Technologies and services deployed	Project partners' countries
 Technologies for consumers Demand response Smart appliances  Grid technologies  Large-scale storage technologies  Distributed storage technologies  Generation technologies	

Coordinator	FLUX50 (Belgium)
-------------	------------------

Other partners:

- EWORX YPIRESIES ILEKTRONIKOU EPICHEIREIN ANONYMOS ETAIREIA (Greece)
- THINK E (Belgium)
- JOANNEUM RESEARCH FORSCHUNGSGESELLSCHAFT MBH (Austria)
- STEINBEIS 2i GMBH (Germany)
- INTERNATIONAL CLEANTECH NETWORK F.M.B.A (Denmark)
- TECHNISCHE UNIVERSITEIT EINDHOVEN (Netherlands)
- INESC TEC - INSTITUTO DE ENGENHARIADE SISTEMAS E COMPUTADORES, TECNOLOGIA E CIENCIA (Portugal)
- RDA - CLIMATE SOLUTIONS UNIPESSOAL LDA (Portugal)
- INSTITUTE OF COMMUNICATION AND COMPUTER SYSTEMS (Greece)
- THE OPEN UNIVERSITY (United Kingdom)



Project Description

Context. The Every1 project aims to deliver an impactful concept that includes all elements needed to enable an effective participation of all European stakeholders in the digital energy market. Every1 uses a deep understanding of stakeholders, networks, regulation, and solutions, to design and deliver tailored learning paths, matching learning as well as capacity building material covering all European languages. The outreach is designed to support and empower and expand local ecosystems that include and reach to local and regional members throughout the quadruple helix, including emerging and existing energy communities, using a diverse range of communication, engagement, training, and matchmaking activities with a lasting impact.

Scope. The project starts from a deep data-informed understanding of stakeholders and ecosystems to map who they are, what they know, how they use information and where they look for it. These stakeholder groups include citizens, cities, energy communities, companies, regulators, and distribution grid operators among others. Existing and emerging solutions will also be assessed and validated within the project and use cases will serve to understand what stakeholders need to know in order to take up a role that matches their potential. The gap analysis created during the project will be used to develop learning pathways that lead to the identification of the needed capacity building material.

The Every1 consortium brings together leading industry experts, who will work on making a market by exchanging best practices with policy makers and energy regulators, enabling discussions on barriers, and developing joint communication material for their peers. Ultimately, this will enable effective participation in the digital energy market and reinforce the digitalisation-of-energy ecosystems

- to support competence clusters for digital energy concepts, enabling them to be autonomous in reacting to local energy transition needs.
- to deliver a lasting & impactful multi-language capacity building program on digitalisation of energy
- to contribute actively to market creation.

Technical description and implementation. A strong outreach campaign will be launched, focussing on the local level with impactful social media campaigns, material in various languages and spread through the media the local stakeholders use. The operation of the ecosystems is based on the proven EXPLORE SHAPE UNITE approach and includes guided one-on-one support, joint activities, webinars, matchmaking, and more. Future ecosystems are actively engaged and trained, while cooperation with diverse activities and networks will lead to a wider uptake of the capacity building material.

Impact. Replicability: Networking, training, learning materials, marketplace and other project reports will be further matured for post-project operation. For example, engaging initiatives such as Project Development Assistance-projects, one-stop-shops for energy communities, energy agencies, networks, to join activities, workshops and training will remain operation and stakeholders will be trained to re-use, re-adapt and remix the learning material to induce a multiplier effect.

Socio-economics: The increasing number of participants in the flexibility markets will lead to a wider socio-economic impact of increasing number of informed customers benefiting from lowered energy bills, reduced energy dependency, and decreased CO2-emissions. Consumer satisfaction will also improve through better offerings enabling consumers to benefit from data-driven energy services and facilitating their investment and engagement in the energy transition, through personal-use, demand response or joint investments in renewables (individually or through energy communities or micro-grids).

Environment: An important socio-environmental impact is the increasing flexibility enabling to shift more demand, and some of the production, leaving room for more intermittent renewable energy.

Market Transformation: Every1 works on creating a market by exchanging best practices with policy makers and energy regulators, enabling discussions on barriers, and developing joint communication material for their peers. Project partners will engage with strategic stakeholders at national, EU level, international level as well as local levels to enable the uptake of the developed material in their activities.





HORIZON-CL5-2021-D3-03-10: Innovative foundations, floating substructures and connection systems for floating PV and ocean energy devices

[Back to projects' list](#)







NATURSEA-PV

NOVEL ECO-CEMENTITIOUS MATERIALS AND COMPONENTS FOR DURABLE, COMPETITIVE, AND BIO-INSPIRED OFFSHORE FLOATING PV SUBSTRUCTURES



NaturSea-PV aims to improve the overall lifetime, reliability, and maintainability of marine substructures for offshore floating PVs and thus reduce its LCOE. For this, NaturSea-PV will develop innovative structural designs capable of handling the harsh marine conditions, at the same time ensuring the durability and minimizing (un)installation costs. The substructures will be built using newly developed environmentally friendly low carbon ultra high performance concrete and will be coated with new biobased antifouling and anticorrosive coatings. A specific predictive simulation toolkit will be developed to assess the mechanical and chemical durability of the new materials under marine conditions and will be validated against experimental data.

From 2022	Project total cost	EU contribution	Website
To 31/10/2026	3.2 M€	3.2 M€	https://www.natursea-pv.eu/

Technologies and services deployed	Project partners' countries
<ul style="list-style-type: none">  Technologies for consumers  Grid technologies  Large-scale storage technologies  Distributed storage technologies  Generation technologies 	

PV

Coordinator FUNDACION TECNALIA RESEARCH & INNOVATION (Spain)

Other partners:

- STICHTING MARITIEM RESEARCH INSTITUUT NEDERLAND (Netherlands)
- UNIVERSITE DE BORDEAUX (France)
- UNIVERSITY COLLEGE CORK - NATIONAL UNIVERSITY OF IRELAND, CORK (Ireland)
- TECHNISCHE UNIVERSITAT DARMSTADT (Germany)
- UNIVERSIDAD DEL PAIS VASCO/ EUSKAL HERRIKO UNIBERTSITATEA (Spain)
- BASQUE CENTER FOR MACROMOLECULAR DESIGN AND ENGINEERING POLYMAT FUNDAZIOA (Spain)
- AGENCIA ESTATAL CONSEJO SUPERIOR DE INVESTIGACIONES CIENTIFICAS (Spain)
- WARRANT HUB SPA (Italy)
- PREFABRICADOS FORMEX SOCIEDAD LIMITADA (Spain)
- RESEARCH & DEVELOPMENT CONCRETES SOCIEDAD LIMITADA (Spain)



Project Description

Context. The green transition strategy of the EU aims to a climate neutral economy by increasing the use of diverse renewable energy sources. Offshore floating photovoltaics (PV) is one of the target technologies, since 71% of the earth's surface is covered by water. Although floating PV is already used in shallow inland waters, its use in offshore environments is not common due to the harsh marine conditions and thus requires a revamping of the technology.

Scope. The strategic objective of NaturSea-PV is to improve the overall lifetime, reliability, and maintainability of marine substructures for offshore floating PV, to reduce degradation and failure rates, and thus investment risk and Levelized Cost of Electricity (LCOE). To achieve this, NaturSea-PV aspires to:

- Develop new conceptual substructure design inspired from nature.
- Develop new circular and more ecological materials and treatments for constructing the substructure.
- Develop improved predictive computational tools to assess and predict the durability of the newly developed materials.
- Test and validate the new materials and components in laboratory and in realistic offshore conditions.
- Verify the regulatory compatibility of the new designs together with socio-economic activity to maximize their acceptance and ensure sustainable impact in line with Mission Healthy Oceans.

Technical description and implementation. The activities of NaturSea-PV can be divided into the following lines

- The substructure design based on the requirements to withstand the harsh marine conditions and LCOE
- Circular materials design (more ecological ultra high performance concrete and coatings) to minimize the carbon footprint and to withstand the marine conditions
- Development of a Probabilistic Predictive Toolkit to assess the durability and performance of the floating offshore PV substructures
- Testing and validation of the designs, materials, components and the simulations tools at the laboratory scale and at realistic offshore conditions and demonstration sites
- Social sciences and humanities integration to investigate the environmental and social dimensions of the project and to engage with the stakeholders regarding future planning in line with Mission Health Oceans.

Impact.

Replicability: NaturSea-PV focuses on the design of a substructure that can be easily replicated to adapt to the size requirements of a particular location. Besides, the new developed materials and tools can be of great interest for the wider field of offshore civil engineering.

Socio-economics: The occupation of large areas of the sea derived from the deployment of removable energy facilities can have a negative impact on traditional uses of the sea. NaturSea-PV will evaluate such impacts and propose corrective measurements.

Environment: NaturSea-PV pursues the development of green materials (eco-UHPC and bio-based coatings) and the evaluation of the environmental impact of floating PV facilities.

Market Transformation: NaturSea-PV solutions aim to reduce the CAPEX and OPEX of the PV substructures and thereby to reduce LCOE and to improve the efficiency of offshore PV technologies.

Policy: Renewable energy harvesting is a relatively new use of the sea that might not be properly addressed in current regulations. NaturSea-PV will assess such regulations and propose modifications to foster the deployment of renewable energy technology in a fair and responsible way.





HORIZON-CL5-2021-D3-03-10: Innovative foundations, floating substructures and connection systems for floating PV and ocean energy devices

[Back to projects' list](#)







PLOTEC

PLOCAN Tested Optimised Floating Ocean Thermal Energy Conversion Platform



PLOTEC aims to design, model and install a successful demonstration of a novel cylindrical ocean thermal energy conversion OTEC platform capable of withstanding the extreme weather effects of tropical oceans, with an economically viable cost model.

From 2022	Project total cost	EU contribution	Website
To 2025	1.3 M€	1.3 M€	https://plotec.eu/

Technologies and services deployed	Project partners' countries
<ul style="list-style-type: none">  Technologies for consumers  Grid technologies  Large-scale storage technologies  Distributed storage technologies  Generation technologies 	
Coordinator	PLOCAN (Spain)

Other partners:

- WAVEC/OFFSHORE RENEWABLES - CENTRO DE ENERGIA OFFSHORE ASSOCIACAO (Portugal)
- QUALITY CULTURE (Italy)
- AGRU KUNSTSTOFFTECHNIK GMBH (Austria)
- GLOBAL OTEC RESOURCES LTD (United Kingdom)
- CLEANTECH ENGINEERING LIMITED (United Kingdom)
- UNIVERSITY OF PLYMOUTH (United Kingdom)



Project Description

Context. Ocean Thermal Energy Conversion (OTEC) plants generate renewable energy using the temperature difference between warmer surface water (heated directly by the sun) and cooler water at seabed level (800 –1000 m). Hot and cold seawater is piped in and run through a novel arrangement of heat exchangers and water condensers, in the process spinning turbines that generate renewable electricity. OTEC provides energy production with zero carbon emissions without using conventional fuels, and is a renewable energy (International Renewable Energy Agency (IRENA), 2014[1]).

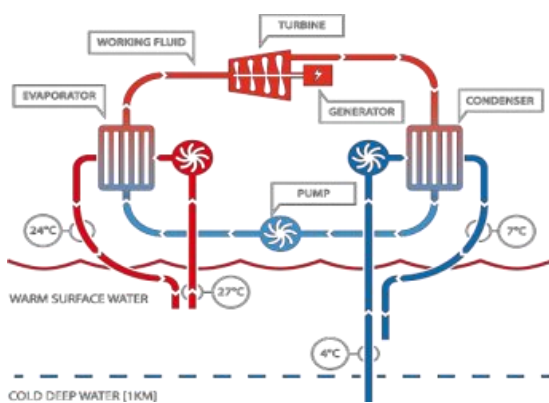

Figure 2 - Ocean Thermal Energy Conversion Cycle

Mass adoption of OTEC technology as an energy industry has been hampered by the high equipment and set up costs which include either (a) large deepwater platforms (floating plants), traditionally in oil & gas, that vary greatly in cost due to sizes and number of barrels per day or (b) massive, multi-kilometer deepwater pipes to be installed on the seabed (land-based plants), where the average inflation-adjusted cost to install FERC pipelines from 1995 to 2014 was \$3.3 million/mile (\$2.1 million/km) in the Gulf of Mexico.

Current barriers to OTEC are not technical but rather financial and knowledge based.

Scope. The project seeks to overcome this key economic barrier by providing novel design and materials in OTEC, enabling better designs, less expensive materials and installations unlocking higher rates of OTEC deployment. The developments in offshore design, improved materials and computational modelling are transferrable to other offshore industries. Significant progress in development of the commercial and technical pathways for offshore OTEC power generation.

Technical description and implementation.

Installation and testing of a scaled demonstrator to understand reliability, installability, operability, and maintainability in a real-world marine environment, and to thereby help significantly reduce investment risk to future OTEC projects.

- Design of an innovative marine structure for a floating offshore ocean energy device (cylindrical hull).

- Design of an innovative mechanical joint, critical for the operation of offshore ocean energy device (sealing gimbal CWP connection).
- Installation and testing of a scaled demonstrator for both systems above, to understand reliability, installability, operability and maintainability of both systems in a real-world marine environment,
- Real-world development and measurement of reduced CAPEX floating system suitable for offshore OTEC, with demonstrable future pathway for reductions in LCOE for future OTEC systems.

Impact. Replicability: Researching Material properties in combination with improved computational modelling tools developed in ORCAFlex ensuring replicability through industry standard usage in marine engineering.

Socio-economics: Reinforced European scientific basis and European export potential for renewable energy technologies through international collaboration (notably with Africa in renewable energy technologies and renewable fuels and enhanced collaboration with Mission Innovation countries).

Reduced cost and improved efficiency of renewable energy and renewable fuel technologies and their value chains. Ensuring cost-effective uninterrupted and affordable supply of energy.

Environment: De-risking of renewable energy with a view to their commercial exploitation and net zero greenhouse gas emissions by 2050.

Market Transformation: Affordable, secure and sustainable renewable energy technologies by improving competitiveness in global value chains and position in growth markets, through the diversification of the renewable services and technology portfolio.

Availability of disruptive renewable energy and renewable technologies and systems in 2050 in order to accelerate the replacement of fossil-based energy technologies.

Policy: Policy Recommendations will be drafted and widespread by the Consortium's broader network. A specific project content strategy for Governments will be designed to influence new policies, remaining in line with the EU Green Deal, the blue economy, renewable energy ambitions in targeted areas.



HORIZON-CL5-2021-D3-03-10: HORIZON-CL5-2021-D3-03-10: Innovative foundations, floating substructures and connection systems for floating PV and ocean energy devices

[Back to projects' list](#)

SUREWAVE

Project Long Title: Structural reliable offshore floating PV solution integrating circular concrete floating breakwater



SUREWAVE will develop and test an innovative concept of Floating Photo-Voltaic (FPV) system consisting of an external floating breakwater structure acting as a protection against severe wave-wind-current loads on the FPV modules, allowing increased operational availability and energy output, thus unlocking the massive deployment of Offshore FPV.

From 01/10/2022

Project total cost

EU contribution

Website

To 30/09/2025

3.515 M€

3.515 M€

<https://surewave.eu/>

Technologies and services deployed

Project partners' countries



Technologies for consumers

Floating PV solution
PV Array integration



Grid technologies

Innovative energy generation solution



Large-scale storage technologies



Distributed storage technologies



Generation technologies



Coordinator

SINTEF (Norway)

Other partners:

- SUNLIT SEA AS (Norway)
- ASOCIACION CENTRO TECNOLOGICO CEIT (Spain)
- STICHTING MARITIEM RESEARCH INSTITUUT NEDERLAND (Netherlands)
- ACCIONA CONSTRUCCION SA (Spain)
- CLEMENT GERMANY GMBH (Germany)
- INSTITUT FUR ENERGIE- UND UMWELTFORSCHUNGSBEREICH GGMBH (Germany)



Project Description

The main objective of SUREWAVE is to develop and test an innovative concept of Floating Photo-Voltaic (FPV) system consisting of an external floating breakwater structure made of new circular materials acting as a protection against severe wave loads on the FPV structure itself, allowing increased operational availability and energy output. Such a concept is able to operate in all the European sea-basins including open-sea very harsh environments with high wind (speed >25 m/s), current (>1.2 m/s) and wave (height >14 m), thus unlocking the massive deployment of Offshore FPV at European and worldwide level. The SUREWAVE project will be focused on the research for securing optimal behaviour at aero & hydrodynamic and structural integrity level of the external breakwater, the internal FPV modular structure, the connections, the mooring and anchoring and the whole FPV system, complying with mechanical, electrical (maximizing energy output) and cost-efficiency requirements, ensuring high lifetime of critical components, high reliability of the system and easy, quick and cost-efficient, construction, installation and O&M of the whole system.

Context. The concept underpinning SUREWAVE is laying on three pillars.

- Pillar-1: R&D of the innovative breakwater concept for the Offshore FPV to be operated in harsh conditions.
- Pillar-2: Development of sustainable new circular materials with improved techno-economic-environmental performance
- Pillar-3: Intelligent predictive modelling tools to ensure an optimal structural integrity, reliability, durability, and improved O&M.

Scope. A complete offshore FPV system developed and validated in relevant environment TRL5 (combining lab test, advanced basin-concept validation and empiric long-term degradation in sea conditions) to be able to operate in offshore extreme conditions, enabling the solar PV sector to maximize affordable solar energy in the oceans. It is conceived to be future scaled up to be a plant about 50MWp, with a power peak of 150W/m² (e.g. 578m square or 652m diameter).

Technical description and implementation. To achieve SUREWAVE overarching goal and its specific objectives, the work plan of **36 months** is divided into eight Work Packages (WP). Besides the cross-cutting WPs, i.e., WP1, dedicated to project management and WP8 (Dissemination, Communication, Exploitation & Societal Engagement), the work plan is grouped into three main blocks of WPs:

- **Block-1:** WP2 is dedicated to the preliminary global framework definition of the floating PV solution based in the breakwater concept. The results will be general specifications for: the development of the global floating PV system, the new materials and the modelling and simulation tools.

- **Block-2:** WP3, WP4 and WP5 are dedicated to the research and technologies development of the floating PV solution (global system integration, breakwater design, new circular concrete material solutions, computational modelling and simulation tools for quick and accurate determination of material properties ensuring structural integrity and lifetime of the solution).
- **Block-3:** WP6 and WP7 entails the testing and validation at technical, social, economic and environmental level of the solution to achieve the TRL5 for the novel SUREWAVE floating PV solution.

Impact. Replicability: 50-100%

Socio-economics:

SOCIAL IMPACT: 3,460 jobs created by 2032. 1,335,608 people with electric coverage with project solution by 2032. 300 social actors engaged thanks to the continuation of the dissemination & communication after project.

ECONOMIC IMPACT: Unlocking offshore FPV deployment. 5-10 energy utilities contracted. Sales expected 25 plants and almost 1 Billion € sales, 1,240 MW installed by year 2032.

Environment:

ENVIRONMENTAL IMPACT: Key structural component of the system made of low carbon circular concrete. Yearly clean energy per farm 85,145 MWh. Yearly clean energy in SUREWAVE total market by 2032 of 2,111,596 MWh. 70,000 t eq CO₂/y GHG emissions avoided per farm installed and 1,736,000 t eq CO₂/y GHG emissions avoided thanks to SUREWAVE facilities by 2032.

Market Transformation:

- Reduction of 40% of over-engineering/design
- Reduction of 35% of fabrication costs
- Reduction of 50% Installation & Transport costs
- Increase by 20% lifetime up to 20 years (equalizing to ground mounted PV)
- Increase 30% electrical & mechanical reliability.
- Reduce by 30% O&M operations and insurance costs.
- Reduce by 70% degradation and critical failures.
- Increase of 30% the energy output.



HORIZON-CL5-2021-D3-03-12: Innovation on floating wind energy deployment optimized for deep waters and different sea basins (Mediterranean Sea, Black Sea, Baltic Sea, North-east Atlantic Ocean)

[Back to projects' list](#)







BLOW

Black sea fLloating Offshore Wind



Let's harness the floating offshore wind energy potential of the Black Sea, let the wind BLOW. Offshore wind is currently one of the most cost-efficient, clean and scalable power sources. As of today, offshore wind farms rest on bottom-fixed foundations and are mainly deployed in shallow water areas with depths less than 50m. Floating offshore wind energy is expected to play a key role to materialise the vast potential of deep-sea areas. Project BLOW aims at unlocking the Black Sea fLloating Offshore Wind potential, by demonstrating a disruptive cost-efficient floating integrative unit design optimised for low and medium wind speed areas. BLOW will implement a 5 MW demonstrator in the Black Sea and will pave the way to industrial mass production and to the deployment of floating offshore wind farms. In order to accelerate the energy transition in the region, the project will couple synergies with the Oil & Gas sector and foster societal acceptance and cross-border policy development. BLOW targets an expected LCOE of 87€/MWh by 2028 (and 50€/MWh beyond 2030) and an environmental impact reduced by 40%

From 2023	Project total cost	EU contribution	Website
To 2027	21.243 M€	15.483 M€	https://blow-project.eu/

Technologies and services deployed		Project partners' countries
	Technologies for consumers	
	Grid technologies	
	Large-scale storage technologies	
	Distributed storage technologies	
	Generation technologies	
Coordinator	IREC- CERCA (Spain)	

Other partners:

- EOLINK (FRANCE)
- Petroceltic (Bulgaria)
- GSP Offshore (Romania)
- CMU (Romania)
- BEIA (Romania)
- CEPS (Belgium)
- BEXCO NV (Belgium)
- MCE (Austria)
- SCU (Turkey)
- DURED (Turkey)
- Fraunhofer (Germany)
- ACCIONA (Spain)
- MGU (Bulgaria)
- EMEC (United Kingdom)
- BUL (United Kingdom)



Project Description

Context. Offshore wind is currently one of the most cost-efficient, clean and scalable power sources. According to the International Renewable Energy Agency (IRENA), the LCOE for offshore wind decreased by 50% between 2010 and 2021. It is expected to keep decreasing in the following years. The UK recently launched its 4th offshore wind energy auction: for the 1st round in 2015, the average winning price was 140€/MWh. For the second and third rounds, it dropped to 67€/MWh in 2017 and down to 48.5€/MWh in 2019². Today, offshore wind farms rest on bottom-fixed foundations and are mainly deployed in shallow water areas with depths less than 50m. To unlock the vast potential of deep-sea areas, floating offshore wind technologies (FOWT) are expected to play a key role. In October 2018, the International Energy Agency (IEA) stated: “The huge promise of offshore wind is underscored by the development of floating turbines that could be deployed further out at sea. In theory, they could enable offshore wind to meet the entire electricity demand of several key electricity markets several times over, including Europe, the United States and Japan”³. Although floating wind has demonstrated its technical feasibility thanks to prototypes, the feasibility of its industrialisation and competitiveness needs to be proved.

Scope. In this context, the general objective of the BLOW project is to unlock the floating offshore wind potential of Class III areas by demonstrating a disruptive cost-efficient floating unit design optimised for low and medium wind speed areas in the Black Sea. BLOW will pave the way to industrial mass production and deployment of floating offshore wind farms to accelerate the energy transition in the region. BLOW will target an expected LCOE of 87€/MWh by 2028 (and 50€/MWh beyond 2030) and an environmental impact reduced by 40%. To reach this ambitious objective, the consortium gathers 16 entities from 9 different countries, including 7 industries & SMEs, 2 industry-driven organisations, 2 research centres, 4 universities and 1 think tank

Specific Objectives

- SO1: Unlock the floating offshore wind potential in the Black Sea.
- SO2: Demonstrate a cost-effective disruptive floating unit pyramidal design optimised for low and medium speed areas.
- SO3: Advanced operation, control and maintenance through Digitalization interest to ensure its widespread integration in remote zones, or for enhancing system reliability.
- SO4: Prove the industrial feasibility of 15-20 MW floating wind turbines with rotor diameters larger than 250 m for mass industrialisation compatible with local manufacturing capabilities.
- SO5: Decrease environmental impact by 40% compared to other FOWT (GHG emissions).
- SO6: Support cross-border policy development and societal acceptance to foster future mass industrialisation and replication of FOWT in the Black Sea.

Technical description and implementation.

BLOW innovation is based on the following main activities:

- Disruptive architecture and turbine adaptation with a large rotor optimised for low and medium wind speed areas targeting a 300W/m² power density
- Innovative Single Point Mooring with anchor piles and power cable layout
- Use of nylon permanent mooring lines
- Subsea part monitoring combined with a digital tool in order to enhance predictive maintenance
- Digital Twin for advanced O&M
- Innovative control techniques for Grid Forming and wind farm optimisation

To demonstrate FOWT competitiveness, BLOW addresses the main current pain points of floating offshore wind industry dealing with:

- the turbine and blades length
- the float, its weight and its industrialisation
- the mooring system
- the installation

Impact. Replicability The market deployment will be done in 3 phases. In phases 1 and 2, BLOW Joint Venture aims to act as an investor. Revenues stream is based on an offtake price and on the ability to provide a competitive tariff compared to other sources of energy. For phase 3, with the deployment of large scale wind farms and the need for substantial investment capacities, BLOW JV aims to act as a leading supplier of integrated products (floater + turbine) in an Engineering, Procurement, Construction and Installation (EPCI) mode. (One notes that GSP, one of the key partners within the BLOW project, currently acts as an EPCI contractor in the O&G industry). These two revenue streams will be deployed in parallel but on two distinct markets: the “niche” market and small scale for phase 2 vs national auctions and large scale for phase 3. This will avoid possible conflict of interest when acting as an investor and a supplier in the same call for tenders.

Sectors relevant for a blue economy

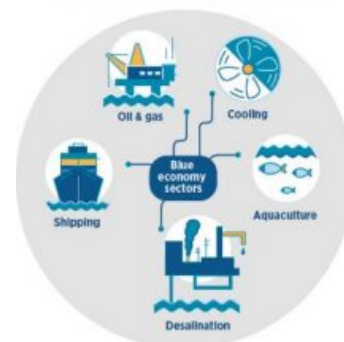



HORIZON-CL5-2021-D3-03-12: Innovation on floating wind energy deployment optimized for deep waters and different sea basins (Mediterranean Sea, Black Sea, Baltic Sea, North-east Atlantic Ocean)

[Back to projects' list](#)

INFINITE INNOVATIVE OFFSHORE WIND TECHNOLOGIES IN DEEP WATERS



The INFINITE project demonstrates floating offshore wind system at 100m water depth with two key technology innovations. The first is a disruptive and environment environment-friendly concrete tension leg platform anchored with an innovative tendon-based mooring system. The platform is designed to work with commercially available WTGs and is scalable, modular and self-installing, showing a vast potential for industrialisation. The second is an innovative aluminium dynamic cable design that is safer, lighter, cheaper and allows for more standardisation in O&M. The demonstrator makes use of a cost optimised O&M strategy that increases accessibility and turbine availability. Moreover, best practices for value co-creation with local stakeholders are applied leading to increased public acceptance of offshore wind developments and an improved Maritime Spatial Planning. The innovations result in an LCOE of 85.3 EUR/MWh at project end and set the path to achieve 43.3 EUR/MWh by 2030. An LCA of the technology innovations developed and an industrial roadmap bringing together innovation needs, supply chain readiness and policy frameworks to allow mass production and deployment complement the project activities.

From 2022 To 31/10/2026	Project total cost	EU contribution	Website
	22.398 M€	15.455 M€	www.infiniteproject.eu

Technologies and services deployed		Project partners' countries
	Technologies for consumers	
	Grid technologies	
	Generation technologies	
	Deployment and validation of an innovative aluminium dynamic cable for floating offshore wind	
	Deployment and validation of an environment-friendly concrete tension leg platform for offshore wind turbine generators	

Coordinator

Other partners:

- ACCIONA CONSTRUCCION SA (Spain)
- ACCIONA GENERACION RENOVABLE, S.A. (Spain)
- FULGOR MONOPROSOPI ANONYMI ETERIA (Greece)
- ELLINIKI VIOMIXANIA KALODIO (Greece)
- ACSM SHIPPING CO SOCIEDAD LIMITADA (Spain)
- FUNDACION CENER (Spain)
- LONDON OFFSHORE CONSULTANTS (France)
- WAVEC/OFFSHORE RENEWABLES –
- CENTRO DE ENERGIA OFFSHORE ASSOCIACAO (Portugal)



Project Description

Context

- Wind energy has become one of the main electricity resources and by 2050 will be the source of half of Europe's electricity;
- Between 100 and 150GW is estimated to be floating wind;
- Europe would need to build 230 floating units per year to achieve that goal;
- It is also key to deploy technologies on waters with more than 60 meters deep;
- To achieve the above targets innovations must be introduced in order to decrease the costs and increase the manufacturability of key components, such as the floating platform and the dynamic cables, as well as the costs associated with the installation, operation and maintenance (O&M).

Scope

- Deploy a disruptive and environment-friendly concrete tension leg platform anchored with an innovative tendon-based mooring system;
- Advance the TRL of such platform and reach level 7;
- Connect the platform to the grid through an innovative aluminium dynamic cable;
- Achieve an LCOE of 85.3 EUR/MWh.

Technical description and implementation

Demonstration of a floating offshore wind system at 100m water depth with two key technology innovations:

- Disruptive and environment-friendly concrete tension leg platform anchored with an innovative tendon-based mooring system;
- Innovative aluminium dynamic cable design.

Impact.

Replicability:

- Improve technology design, fabrication and assembly processes;
- Use of reusable tendon components that can be disconnected and re-deployed on other projects;
- Collect data to develop XXL wind turbine platform constructiveness, O&M, deployment and make good use of the economy of scale

Socio-economics:

- Development of a social integration plan;
- Stakeholder engagement;

Environment:

- Environment-friendly concrete floating platform;
- Environmental conditions and environmental monitoring of the deployment area;
- Environmental sustainability assessment;
- Development of an Environmental Management Plan;

Market Transformation:

- Disruptive TLP floating wind platform;
- Innovations on the subsea dynamic cable market;

Policy:

- Roadmap with a policy framework;
- Recommendations on the Maritime Spatial Planning considering future floating wind projects;
- Exploitation plan targeting policy makers;





HORIZON-CL5-2021-D3-03-12: Innovation on floating wind energy deployment optimized for deep waters and different sea basins (Mediterranean Sea, Black Sea, Baltic Sea, North-east Atlantic Ocean)

[Back to projects' list](#)







NEXTFLOAT

Next Generation Integrated Floating Wind Optimized for Deep Waters

Next Float
Next Generation
Integrated Floating Wind
Optimized for Deep Waters

NEXTFLOAT's main objective is to demonstrate a competitive and sustainable integrated FOW solution optimized for deep waters that will contribute to reaching an LCOE <54 €/MWh in 2030 and accelerate the rate of deployment of floating offshore wind

From November 2022 To May 2027	Project total cost	EU contribution	Website
	35.3 M€	15.9 M€	TBD

Technologies and services deployed	Project partners' countries
<ul style="list-style-type: none">  Technologies for consumers  Grid technologies  Large-scale storage technologies  Distributed storage technologies  Generation technologies 	
<ul style="list-style-type: none"> Wind Turbine Floating Offshore wind 	
Coordinator	TECHNIP ENERGIES (Netherlands)

Other partners:

- TECHNIP ENERGIES FRANCE
- CYBERNETIX (FRANCE)
- X1WIND (SPAIN)
- NATURGY (SPAIN)
- 2-B ENERGY HOLDING BV (NETHERLANDS)
- HELLENIC CABLES (GREECE)
- DTU (DENMARK)
- HYDRO (SWEDEN)
- OCAS (BELGIUM)
- ECOLE CENTRALE DE NANTES (FRANCE)
- SCHWARTZ HAUTMONT (SPAIN)
- TERSAN (TURKEY)
- OCEAN ECOSTRUCTURES (SPAIN)



Project Description

Context.

The EU Strategy on Offshore Renewable Energy targets 300GW of offshore wind by 2050 in Europe to achieve climate neutrality. In this scenario, floating offshore wind (FOW) is the key to unlock 80% of the Europe's offshore wind resources, which are located in waters deeper than 50 metres. ETIPWind proposes to increase EU floating wind capacity from 113MW (18 turbines) today to 150GW by 2050 in order to support Europe's efforts to become climate-neutral by this date. However, the industry still has several challenges that need to be addressed if we are to achieve this ambitious increase of capacity. Specific innovations are necessary to increase the competitiveness of the technology and decrease the Levelised Cost of Energy (LCOE) to €100-60/MWh by 2030 from the current €200-170/MWh in the few existing pre-commercial farms.

Scope.

The NEXTFLOAT project proposes a disruptive, fully integrated FOW system that brings several benefits versus the state-of-the-art designs, including a reduction of 33% in CAPEX (CAPEX >5.8M€/MW for the prototype) and 32-52% in OPEX, and a TLP mooring design optimized for deep waters (>60m), mass manufacturability and scalability for larger turbines (20MW+).

Technical description and implementation.

- Structurally efficient platform with a TLP mooring system, specifically designed for floating wind integrated with a 2-bladed downwind turbine.
- The proposed system provides excellent scalability as 1) it is increasingly **more competitive for larger turbines** with a more effective tripod structure that reduces the increasing bending moments in tower-based systems, and 2) proposes a small TLP mooring system **with better scalability into deep waters** than catenary mooring systems. Other advantages driven by the design are related to **OPEX** by reducing component fatigue, using passive systems and minimising the use of heavy lift vessels for the installation.
- The prototype will ensure minimal environmental and social impact of floating wind across its life-cycle using sustainable innovative concepts and creating a standard impact assessment methodology (30% less blade material compared to 3-bladed turbine, 20_40 steel weight reduction, >90% reduction of the anchoring system seabed footprint)

Impact.

Replicability: The solution will be upscaled to 14MW (detailed design) including industrialization plans for mass fabrication and replicability in different EU sea basins. Also, the technology scalability to 20MW will be studied (concept level).

Socio-economics: NEXTFLOAT will contribute to the socioeconomics impacts, where the wind technology effects will be assessed on the local society through the

consultation of local communities and the development of a specific methodology for socio-economic assessment in future wind farms. Thanks to its wide experience, ECN has built a strong link with local and national authorities for safety and environmental purposes as well as with a wide community (local stakeholders, public, industry, academic...) that will be interacting with NEXTFLOAT

Environment: NEXTFLOAT also **decreases the environmental impact of FOW systems** reducing impacted seabed area, raw materials and bird hit-rate whilst also **improving marine biodiversity** at the floater and foundation level.

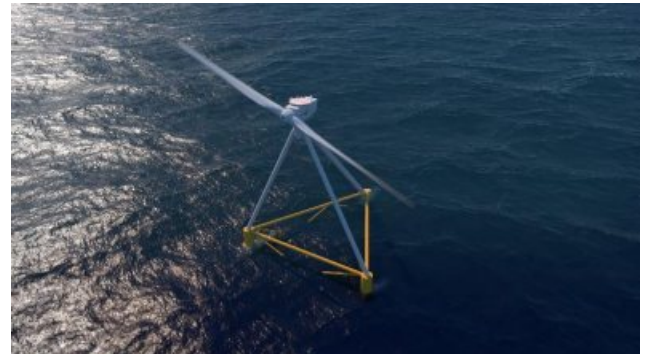



HORIZON-CL5-2021-D3-03-12: Innovation on floating wind energy deployment optimized for deep waters and different sea basins (Mediterranean Sea, Black Sea, Baltic Sea, North-east Atlantic Ocean)

[Back to projects' list](#)







WHEEL

Wind Hybrid Evolution for Low-Carbon Solutions



The WHEEL project's objective is to fully demonstrate and bring to a precommercial Technology Readiness Level (TRL) a revolutionary floating wind technology suited for deep waters locations, effective industrialization strategies, breakthrough cost reduction and minimized carbon footprint.

From 2023	Project total cost	EU contribution	Website
To 31/12/2027	25.590 M€	16.664. M€	TBD

Technologies and services deployed		Project partners' countries
 Technologies for consumers	Demand response	
 Grid technologies	Network management and control tools	
 Large-scale storage technologies		
 Distributed storage technologies		
 Generation technologies	Wind turbine	
 Market	Electricity market	

Coordinator ESTEYCO (Spain)

Other partners:

- 2-B ENERGY SL (Netherlands)
- CONSORCIO PARA EL DISEÑO, CONSTRUCCIÓN, EQUIPAMIENTO Y EXPLOTACION DE LA PLATAFORMA OCEANICA DE CANARIAS (PLOCAN) (Spain)
- ROVER MARITIME SOCIEDAD LIMITADA (Spain)
- FUNDACION INSTITUTO DE HIDRAULICA AMBIENTAL DE CANTABRIA (Spain)
- ENBW ENERGIE BADEN-WURTTENBERG AG (Germany)
- BEKAERT WIRE ROPE INDUSTRY NV (Belgium)
- BOSKALIS OFFSHORE MARINE SERVICES BV (Netherlands)
- VICINAY SESTAO SOCIEDAD LIMITADA (Spain)
- REPARACIONES NAVALES CANARIAS SOCIEDAD ANONIMA (Spain)



Project Description

Context. Floating offshore wind has the potential to unleash a new European industrial sector able to deliver clean and sustainable energy. Building from European technological and industrial know-how and harnessing the natural resources of the different sea basins around the European Union, namely the Mediterranean Sea, the Black Sea, the Baltic Sea and the North-east Atlantic Ocean, there is an opportunity to leverage these conditions into technological leadership, while supporting the goal of climate neutrality.

Scope. The WHEEL project will go beyond the state-of-the-art in multiple topics related to floating wind which are indeed aligned with several recognized pain points that the floating wind industry must overcome in its pathway towards large scale commercial projects.

The project will break ground in multiple related but independent aspects: putting to the test an advantageous wind turbine configuration which is unprecedented in floating wind, innovating and testing new-generation synthetic materials for the mooring system, developing and testing new patented floating control strategies to overcome negative damping effects or designing patented solutions for on-site large corrective maintenance of floating wind turbines, which is a long-standing demand of the industry. All these ground-breaking solutions have been conceived to address the specific requirements -and opportunities- of floating energy industrial production, installation, and operation. The WHEEL project will demonstrate the potential of such innovations when working together, but indeed many of them can be applied independently and as part of other floating wind solutions.

Technical description and implementation. The WHEEL technology is an evolved spar concept that uses a lowerable weight suspended from the upper structure with tendons. Once in deeper waters, the weight is lowered, and the tensioned cables will behave as triangularised rigid bars which make the ballast weight solidary with the whole system.

The floater therefore comprises two tanks, an upper one which provides the required buoyancy, and a lower one which houses the ballast weight. The upper buoyancy tank is conveniently submerged in operation, keeping it away from the concentrated wave energy on the surface. A steel tripod structure will act as transition piece between the upper tank and the wind tower.

The WHEEL floater evolved spar concept is disruptive with regards to the construction and installation process. The upper and lower tanks can be positioned together, one inside the other, acting as one barge-type platform which provides adequate stability during temporary construction and installation stages.

Thus, WHEEL capitalizes on the transparency and stability characteristics of a spar while allowing for quayside turbine integration, much like semisubmersibles or barge

solutions, but with a much more compact width and reduced draft in harbor. Specifically, for a 15MW design, such “barge” has 26m radius and 5.3m draft, roughly half of an equivalent semisubmersible alternative. These key aspects, together with a concrete-based hull, decisively widen the range of suitable harbors and thus open options to pursue local manufacturing strategies that may overcome the harbor infrastructure constraints.

In the “barge” configuration, buoyancy keeps the upper and lower tanks pressed against each other, behaving as one single solidary hull. Once in sufficiently deep waters, the lower tank can be deployed in a controlled manner and WHEEL will achieve an ultra-stable transparent configuration for operation.

Impact. Replicability: The WHEEL solution has been conceived so that it may rely on a wide and capable local supply chain and facilitate overcoming supply chain bottlenecks that the industry is anticipating, such as those related to the need for large and specialized shipyards prepared to handle the manufacturing, stocking and load-out of very large steel hulls with the high production rates that commercial projects shall demand.

Socio-economics: WHEEL offers outstanding opportunities for local content generation. The fact that it is mainly made of concrete increases its possibilities to maximize economic benefits linked to both local workforce and material sourcing.

Environment: The WHEEL floater solution aims to deliver a radical reduction in emissions and carbon footprint based on: a) Using concrete instead of steel; b) Largely reducing material usage; c) Enabling local construction strategies. Circularity is also incorporated from the earliest design stages, using materials that are recyclable and/or reusable.

Market Transformation: Based on the advantages of the WHEEL, the Consortium is confident that it will be well received in the European market where a strong effort is being made to reduce carbon emissions and cement its leadership in renewables globally.

Policy: Esteyco, the coordinator of the project, is the only company that has obtained authorisation to energy production in territorial sea in Spain. Therefore, we are confident to state that we are well aware of the legislation and the procedures to obtain the approval for this new offshore wind energy project located in PLOCAN, Spain.



**HORIZON-CL5-2021-D5-01-03: System approach to achieve optimised Smart EV Charging and V2G flexibility in mass-deployment conditions (2ZERO)**[Back to projects' list](#)

Drive2X





Delivering Renewal and Innovation to Mass Vehicle Electrification Enabled by V2X Technologies

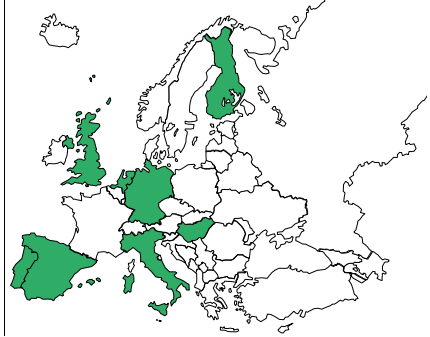

DRIVE2X

This multidisciplinary four-year long project will develop new knowledge, tools, models, and technologies to help cope with a V2X-based mass EV deployment future. Drive2X will implement novel artificial intelligence techniques that efficiently capture the flexible energy potential from advanced smart charging in building parking lots, homes, and charging stations, and match it with the distribution networks' localized needs in order to research dynamic marketplaces for exchanging and trading EV charging flexibility locally. It will develop next-generation lower-cost bidirectional charger units and test it in five complementary European demonstrators. Lastly, it will study and consolidate the understanding of user behaviour uncertainties linked to smart charging and develop policy tools to support EV roll-out in smart cities.

From 2023	Project total cost	EU contribution	Website
To 31/12/2026	10,5 M€	9.2 M€	http://www.drive2x.eu/

Technologies and services deployed		Project partners' countries
 Technologies for consumers	Demand response Smart metering	
 Grid technologies	Bidirectional EV chargers Network management, monitoring and control tools	
 Distributed storage technologies	Microgrid Batteries Electric vehicles	
 Generation technologies	Thermal Energy Storage PV Micro-generation	
 Market	Electricity market DSO flexibility services	

Coordinator: LUT University (Finland)**Other partners:**

- CNET CENTRE FOR NEW ENERGY TECHNOLOGIES SA (Portugal)
- LABELEC ESTUDOS DESENVOLVIMENTO E ACTIVIDADES LABORATORIAIS SA (Portugal)
- ENGINEERING - INGEGNERIA INFORMATICA SPA (Italy)
- NEDERLANDSE ORGANISATIE VOOR TOEGEPAST NATUURWETENSCHAPPELIJK ONDERZOEK TNO (Netherlands)
- DEUTSCHES ZENTRUM FUR LUFT - UND RAUMFAHRT EV (Germany)
- TECHNISCHE UNIVERSITAT DORTMUND (Germany)
- FUNDACION TECNALIA RESEARCH & INNOVATION (Spain)
- POWER RESEARCH ELECTRONICS B.V. (Netherlands)
- TECHNISCHE UNIVERSITEIT DELFT (Netherlands)
- FONDAZIONE ICONS (Italy)
- EMOTION SRL (Italy)
- ASM TERNI SPA (Italy)
- SZEKELY FAMILY & CO. NONPROFIT KORLATOLT FELELOSSEGU TARSASAG (Hungary)
- GEMEENTE AMSTERDAM (Netherlands)
- ANA - AEROPORTOS DE PORTUGAL, SA (Portugal)
- FUTURE ISLE OF WIGHT CIC (United Kingdom)
- THE NOTTINGHAM TRENT UNIVERSITY (United Kingdom)



Project Description

Context. Global electric vehicle (EV) sales across all transport modes have grown steadily over the last decade. By the end of 2021, there were over 11 million EVs on the road, whereas in 2010 this number was no greater than 500.000 cars. The shift to electromobility is strongly gaining momentum, and expert predictions place the worldwide EV stock between 700 million and 1.1 billion units by 2050. In Europe, this inexorable growth is seen both as an opportunity and an infrastructural threat: On one hand, **the mass deployment of EVs carries a hidden game-changing decarbonization potential.** On the other hand, if scaled up to mass-market levels, the currently mainstream technical approaches to EV charging control, either pricing-driven or on/off-based, will create dangerous disruptions in power system peak demand. Thus, **an effective shift to mass electromobility needs to be accompanied by robust technical advancements in digitally controlled smart charging techniques and by technological improvements in bidirectional EV charging solutions.** This bidirectionality is the key technology feature that will lend the power system the ground-breaking levels of flexibility it needs to accommodate higher shares of renewables.

Scope. Among the different smart charging approaches, bidirectional EV charging (V2X) is the most advanced, the main forms of which include **Vehicle-to-grid (V2G)**, **Vehicle-to-building (V2B)**, and **Vehicle-to-home (V2H)**. These approaches can unlock more flexibility in the power system than V1G or basic smart charging, despite being less market mature. It is thus paramount to consolidate market instruments and business cases that further incentivize synergistic cooperations between EV users and the power system, while enabling the stacking of various grid services provided by advanced smart charging technologies and their value streams. DriVe2X is focused on local flexibility value, i.e., **DSO-level services and behind-the-meter optimization strategies.**

Technical description and implementation. The DriVe2X project develops new expert knowledge, ICT solutions, and hardware technologies to help cope with a V2X-based mass EV deployment future. Also it explores the role of behavioural uncertainties in V2X and develops policy tools to support V2X roll-out in smart cities.

The six main objectives of DriVe2X are:

- To improve and consolidate **the understanding of V2X concepts and technologies.**
- To identify **user experience and behavioural challenges** of different V2X charging approaches.
- To design and demonstrate a localized and **user centric V2X marketplace.**
- To develop and demonstrate **novel, affordable, user-friendly V2X solutions** and charging technologies

- To assess **impacts from mass deployment of V2X technologies** on the distribution grids and on the energy markets and energy systems as a whole.
- To support the furthering of **V2X open research activities and market scale-up.**

The work is divided into 10 complementary work packages (WPs), being that cornerstone V2X issues such as user behaviour (WP2), battery degradation (WP6), and upscaling (WP10) are explicitly addressed in the project.

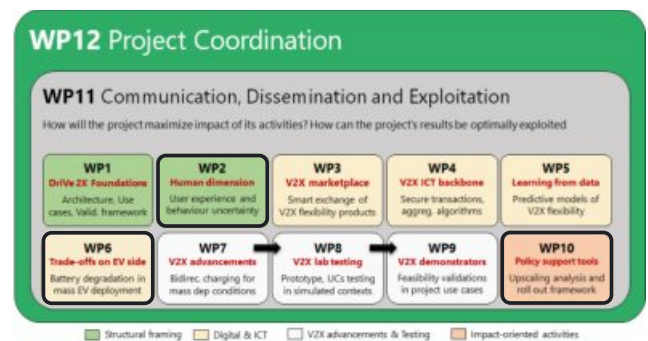

Impact. *Replicability:* To ensure maximum representativeness of results, project advancements will be tested and validated in five demonstration sites, which are spread across Europe, each framed at different geographic and urban contexts and facing disparate green transition challenges: The **Isle of Wight (UK)**, the **City of Maia (PT)**, including that city's main Airport – Sá Carneiro Airport, the **City of Terni (IT)**, the **City of Amsterdam (NL)**, and the **City of Budapest (HU)**. In these demonstrators, DriVe2X will assess benefits of V2X for various market actors, while considering multiple charging scenarios, including public charging station facilities (V2G), building parking lots (V2B), and private homes (V2H). WP10 and WP11 provide dedicated exploitation, replication, and uptake analyses, supported by test implementations of a policy framework in the cities of Amsterdam and Terni.

Socio-economics: DriVe2X promotes the emergence of new flexibility markets based on advanced smart charging and thus the **untapping of new value creation opportunities for EV owners and prosumers**, facilitating and supporting their further engagement in the EU's energy transition. The project also supports the role of new market actors, such as aggregator entities, helping improve Europe's economy.

Environment: Due to supporting the accelerated uptake of electric mobility and bidirectional charging, DriVe2X contributes to increasing the flexibility of the EU power system, thus **helping expand the host capacity for intermittent renewable energies** (e.g., solar and wind).

Market Transformation: By establishing new market services, products, and business models around **V2X flexibility as a tradable commodity**, the project strongly supports the sustainable EU electricity market reform.

Policy: One of DriVe2X's main outputs is a reference policy framework for supporting the **roll-out and market structuration of V2X** in European smart cities.



HORIZON-CL5-2021-D5-01-03: System approach to achieve optimised Smart EV Charging and V2G flexibility in mass-deployment conditions (2ZERO)

[Back to projects' list](#)

EV4EU

Electric Vehicles Management for carbon neutrality in Europe



EV4EU aims to propose and implement bottom-up and user-centric Vehicle-to-Everything (V2X) management strategies creating the conditions for the mass deployment of electric vehicles.

From 2022	Project total cost	EU contribution	Website
To 30/11/2025	8.99 M€	8.99 M€	https://ev4eu.eu

Technologies and services deployed		Project partners' countries
Technologies for consumers Grid technologies Large-scale storage technologies Distributed storage technologies Generation technologies Market	Demand response Smart metering Network management, monitoring and control tools Batteries Electric Vehicles Wind turbines Photovoltaic (PV) Electricity market Ancillary services	

Coordinator	Instituto de Engenharia de Sistemas e Computadores, Investigação e Desenvolvimento em Lisboa - INESC-ID (Portugal)
--------------------	---

Other partners:

- UNIVERZA V LJUBLJANI (SLOVENIA)
- DANMARKS TEKNISKE UNIVERSITET (DENMARK)
- SMART ENERGY LAB- ASSOCIATION (PORTUGAL)
- ELEKTRO CELJE D.D. (SLOVENIA)
- BORNHOLMS ENERGI OG FORSYNING AS (DENMARK)
- DIACHEIRISTIS ELLINIKOU DIKTYOU DIANOMIS ELEKTRIKIS ENERGEIAS AE (GREECE)
- CAMPUS BORNHOLM (DENMARK)
- AIGLON ANONYMI VIOMICHANIKI KAI EMPORIKI ETAIREIA AYTOKINITON (GREECE)
- ABB INZENIRING DOO (SLOVENIA)
- SECRETARIA REGIONAL DOS TRANSPORTES TURISM E ENERGIA (PORTUGAL)
- CNET CENTRE FOR NEW ENERGY TECHNOLOGIES SA (PORTUGAL)
- GEN-I, TRGOVANJE IN PRODAJA ELEKTRICNE ENERGIJE, D.O.O. (SLOVENIA)
- DIMOSIA EPICHEIRISI ILEKTRISMOU ANONYMI ETAIREIA (GREECE)
- CIRCLE CONSULT APS (DENMARK)
- EDA – ELECTRICIDADE DOS ACORES SA (PORTUGAL)
- OBCINA KRSKO (SLOVENIA)
- OBMOCNA OBRTNO-PODJETNISKA ZBORNICAKRSKO (SLOVENIA)
- REGIONALNA RAZVOJNA AGENCIJA POSAVJE (SLOVENIA)
- NISSAN MOTOR MANUFACTURING (UK)
- ASSOCIAÇÃO NACIONAL DE TRANSPORTES PÚBLICOS RODOVIÁRIOS MERCADORIAS (PT)
- VESTAS WIND SYSTEMS A/S (DENMARK)



Project Description

Context. In Europe, the transport sector is responsible for 23% of Greenhouse Gas Emissions (GHG), and it is 92% dependent on oil⁵, of which 84% is imported, representing a cost of around €187 billion a year⁶. The road transport industry is undergoing a transition towards electrification of the offered vehicle models. Two main factors drive this change: i) the strict rules imposed by governments on the use of fossil fuels mainly because of environmental concerns, and ii) people are willing to switch to more sustainable and environmentally friendly modes of transport. The massive use of electric vehicles (EVs) will also significantly contribute to carbon neutrality targets for 2050 as defined by the European Commission⁷. However, the mass deployment of EVs presents several challenges, such as the market maturity and costs of EVs, user adoption, infrastructure, and lack of policies promoting EVs⁸.

Scope. EV4EU aims to develop management strategies that allow the massification of electric vehicles, considering the impact on batteries, user needs, power systems, including energy market integration, and on cities' transformation. The project will propose Vehicle-to-Everything (V2X) management strategies that will be tested in four demonstration sites, allowing an evaluation of the advanced control methodologies and tools, the definition of the appropriate implementation conditions, and a consolidation of the most promising solutions and corresponding business models.

Technical description and implementation. EV4EU tackles a variety of challenges associated with the seamless mass integration of EVs in the transport sector, the power system, and society in general. Four complimentary demonstrators will be implemented in Portugal, Greece, Slovenia and Denmark. The demonstrators' activities are organized in 12 Use Cases (UC) addressing different challenges related to the mass deployment of EVs. A simulation tool will be developed, allowing the evaluation of the proposed solutions at a larger scale.

Impact. Replicability: EV4EU methodologies and solutions will be developed considering different operation contexts, business models and country ' legislation/regulations. This approach enables the replication of the proposed solutions by most countries in different regions.

Socio-economics: Solutions that will be developed in the EV4EU will be adopted by the partners in real operation. A charging solution will be tested and patented in the context of the project and innovative business solutions will be evaluated considering their adoption by the users and the adequacy to provide different services.

Environment: EV4EU solutions promote GHG reduction and decarbonization of road transport in Europe and the coordination between EVs and renewables. Electrification of the transport sector is a key aspect of the energy transition.

Market Transformation: Solutions and business models that will be tested in EV4EU will contribute to the major changes in the e-mobility market, power systems sector and cities organization.

Policy: EV4EU will propose regulatory frameworks based on the demonstrators' results to promote EV adoption and charging infrastructure development.

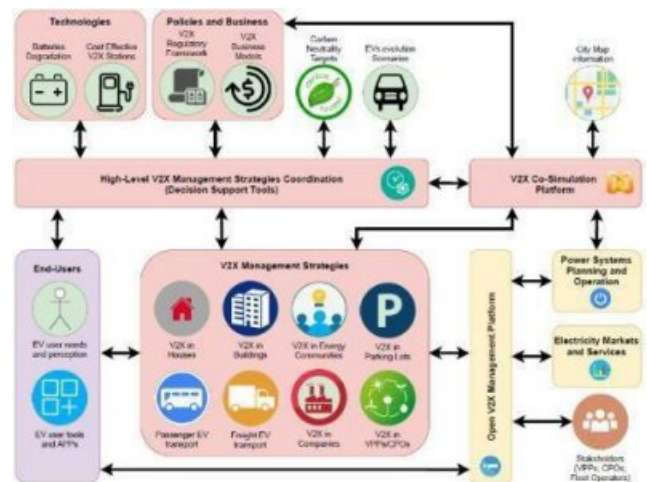

Figure 3 - EV4EU proposed solutions overview

⁵ International Transport Forum, How transport CO2 reduction pledges fall short, 2018

⁶ European Commission, Europe in Move: Encouraging Clean and Sustainable Mobility, 2017

⁷ European Environment Agency, Electric vehicles and the energy sector - impacts on Europe's future emissions, 2021

⁸ Striani, S., Sevdari, K., Calearo, L., Andersen, B. P., & Marinelli, M., Barriers and Solutions for EVs integration in the Distribution Grid, ISGT 2021, Accepted



HORIZON-CL5-2021-D5-01-03: System approach to achieve optimised Smart EV Charging and V2G flexibility in mass-deployment conditions (2ZERO)

[Back to projects' list](#)





FLOW



Flexible energy systems Leveraging the Optimal integration of EVs deployment Wave

FLOW boosts and demonstrates multifaceted EV smart charging and V2X integration into energy systems thanks to a range of comprehensive solutions providing answers to the needs of all actors involved. These solutions include highly replicable user-centric products, concepts, configurations and mechanisms to optimise operation. Cross-sector harmonisation and standardisation is delivered to facilitate activities of stakeholders and EV users. These solutions are deployed in 5 demonstrations in CZ, IE, IT, DK, and ES covering a wide range of applications to validate and quantify the benefits associated with enabling and valorising EV flexibility, alleviating grid challenges, and fostering mobility and energy decarbonization.

From 07/2022	Project total cost	EU contribution	Website
To 06/2026	9.87 M€	9.87 M€	https://www.theflowproject.eu/

Technologies and services deployed		Project partners' countries
 Technologies for consumers	Demand response	
 Grid technologies	DSO platform TSO-DSO	
 Distributed storage technologies	V2G EV	
 Generation technologies	PV	

Coordinator	IREC (Spain)
-------------	--------------

Other partners:

- DANMARKS TEKNISKE UNIVERSITET (Denmark)
- TECHNISCHE UNIVERSITEIT DELFT (Netherlands)
- HELIOX BV (Netherlands)
- RICERCA SUL SISTEMA ENERGETICO - RSE SPA (Italy)
- ENEL GRIDS S.R.L. (Italy)
- E-DISTRIBUZIONE SPA (Italy)
- ARETI S.P.A. (Italy)
- ACEA ENERGIA SPA (Italy)
- EDISTRIBUCION REDES DIGITALES SL (Spain)
- ENEL X SRL (Italy)
- ENDESA X SERVICIOS SL (Spain)
- RHEINISCH-WESTFAELISCHE TECHNISCHE HOCHSCHULE AACHEN (Germany)
- UNIVERSITY COLLEGE DUBLIN, NATIONAL UNIVERSITY OF IRELAND, DUBLIN (Ireland)
- R2M SOLUTION SPAIN SL (Spain)
- EATON ELEKTROTECHNIKA SRO (Czechia)
- EATON INTELLIGENT POWER LIMITED (Ireland)
- NATIONAL UNIVERSITY OF IRELAND MAYNOOTH (Ireland)
- TERNA - RETE ELETTRICA NAZIONALE SPA (Italy)
- EUROPEAN DISTRIBUTION SYSTEM OPERATORS FOR SMART GRIDS (Belgium)
- Spirii ApS (Denmark)
- ENGINEERING - INGEGNERIA INFORMATICA SPA (Italy)
- TECHNISCHE UNIVERSITAET CHEMNITZ (Germany)
- L'ASSOCIATION EUROPEENNE DE LA MOBILITE ELECTRIQUE (Belgium)
- BAYERISCHE MOTOREN WERKE AKTIENGESELLSCHAFT (Germany)



Project Description

Context. – Fostering EV mass-deployment and alleviating grid issues

The energy and mobility systems are undergoing massive electrification with forecasted low-emission vehicles and recharging points spiking over the next few years, supported by ambitious policies, aiming for a climate neutral EU transport and energy systems by 2050. This exponential growth presents challenges including significant increase in household electricity consumption but also brings great opportunities since Electric Vehicle (EV) smart charging, possibly connected with local RES and Energy Storage System (ESS) provides grid operators with additional flexible assets to address network needs if integrated user-centric solutions are designed. Since cars are parked approximately 90% of the time, this concept is particularly clear in both Smart (i.e., V1G) and Bidirectional (i.e., V2X) Charge that can provide grid services by modulating/ injecting/ absorbing electricity from the grid based on grid operators' needs and market opportunities, while providing local benefits via behind-the-meter (BTM) optimisation leading a maximised energy efficiency and local use of RES, fostering customers' involvement through new services and tools.

Scope – Optimal smart charging/V2X concepts

FLOW aligns with the vision that smart charging/V2X is essential to enable successful integration of mobility and energy infrastructures fostering EV mass-deployment and alleviating grid issues (e.g., reinforcement needs, congestions). This can only be achieved via a coordinated and comprehensive approach promoting harmonisation, user-centric design of technologies and services, interoperability, advanced solutions for smart charging design and operation and system-level platforms enabling EV-based flexibility services. These empower EV users and unlock EV flexibility potential to participate in the mobility and energy transitions, while fostering RES penetration.

Technical description and implementation

FLOW leverages SGAM (Smart Grid Architecture Model) to integrate smart-charge and V2G as distributed energy resources that are optimised to provide flexibility services ensuring electric grids to absorb mass-deployment of electro mobility. FLOW focuses on each of the SGAM layers. At the Component Layer develops ESVE, power converters, controllers, EMS that can be incorporated into BTM and enable integration at system level. At the Communication Layer, FLOW defies harmonisation and standardisation of definition, services and requirement to provide seamless exchange. At the Information Level, the data model, data sharing, interoperability and a data governance based on blockchain and mindful of data security are developed. For the Function Level, FLOW defines and validates a wide range of use cases that provide a quantified benefits and lessons learnt for replication. Leveraging the Business mindset of several of the established entities, FLOW develops innovative business models, pricing schemes, services based on current/future policies.

Impact.

The FLOW path to achieve the impacts starts with an impressive team covering the entire value chain across several countries and with unique market roles, providing the team and associated networks with the opportunity to make immediate impacts and boost replicability thanks to the developed and demonstrated solutions.

Replicability: A roadmap for scalability to reach mass deployment and seamless integration of mobility and energy sectors will be produced considering different scenario alternatives and strategies. A Scalability and Replicability Analysis (SRA as adopted by BRIDGE initiative) will be also conducted to understand the effect of the proposed context of solutions (energy, mobility and ICT driven) and to infer the impacts that may be expected from the market roll-out of them. OEM and User Panels will be leveraged to amplify replicability.

Socio-economics: The socio-economic impact of FLOW is severalfold. In terms of social impact the aim is to increase user acceptance and social benefits (improved energy security, improved air quality, reduction of noise pollution). In terms of the economic impact, the goal is to increase revenues for EV users up to 400€ annually through V2X, develop multi-benefit innovative EV flexibility markets and reduce grid investments by up to 1.3 B€ annually per country.

Environment: FLOW's environmental impacts include reduction of the GHG emissions by more than 600 000 tons of CO2 annually, reduction of the SO2, NOx and particulate matters as well as reduction of the RES curtailment of 3 TWh by 2040.

Market Transformation: Several local flexibility market and coordination schemes will be tested in the demonstration campaigns. The aim of these schemes is to facilitate the interaction between the different actors and the provision of flexibility services from the EVs.

Policy: On of the expected outcomes of FLOW is the impact on policy and regulation. The objective is to revise the current regulatory framework and propose regulations and tariffs that favour EV deployment.

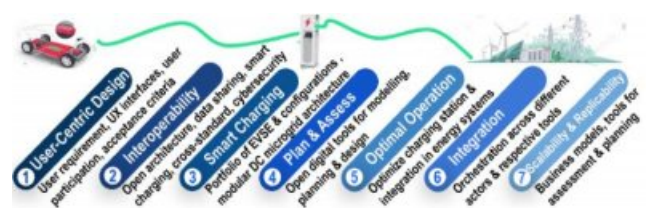



HORIZON-CL5-2021-D5-01-03: System approach to achieve optimised Smart EV Charging and V2G flexibility in mass-deployment conditions (2ZERO)

[Back to projects' list](#)

XL-Connect

Large scale system approach for advanced charging solutions



The overall project objective is to optimize the entire charging chain - from energy provision to the end user - to create a clear benefit for all stakeholders. Therefore, a ubiquitous on-demand charging solution based on an optimized charging network considering human, technical and economic factors along the entire charging chain shall be developed.

From 01/01/2023	Project total cost	EU contribution	Website
To 30/06/2026	8.3 M€	8.3 M€	TBD

Technologies and services deployed		Project partners' countries
Technologies for consumers	Demand response	
Grid technologies	Network management, monitoring and control tools Micro-grid	
Large-scale storage technologies		
Distributed storage technologies	Electric Vehicles	
Generation technologies	PV	

Coordinator	ViV (AT)
--------------------	-----------------

Other partners:

- UNIFI (IT)
- IFPEN (FR)
- ABEE (BE)
- IDIADA (ES)
- RICARDO CZ (CZ)
- UNR (NL)
- FEV (DE)
- EURE (ES)
- RWTH (DE)
- AIT (AT)
- MYC (CZ)
- REGIO (DE)
- ABB (IT)
- UWB (CZ)
- E-REDES (PT)
- DCCS (AT)
- CIRCONTROL SA (ES)
- Neuman (AT)
- BMW GROUP (DE)
- ESTRA S.p.A. (IT)



Project Description

The number of battery-powered electric vehicles is expected to be at 30-40 million by 2030 in the EU. This strong increase of electric vehicles is a big challenge for the energy system in Europe, but at the same time a chance to use V1G/V2G/V2X-technologies. As vehicles are mainly parking, they can be used as energy storage in order to increase grid stability.

The overall project objective is to optimize the entire charging chain - from energy provision to the end user - to create a clear benefit for all stakeholders. Therefore, a ubiquitous on-demand charging solution based on an optimized charging network considering human, technical and economic factors along the entire charging chain shall be developed.

The investigation of the user behavior as well as the analysis of the energy system and grid will form the basis from a research side, to predict the future behavior of EV owners and fleet operators as well as possible shortcomings in the electric grid and energy system. The development of advanced charging technologies and control mechanisms as well as advanced charging and sector coupling concepts, will form the basis for the virtual and real evaluations/demonstrations conducted in 4 different European countries (Belgium, Germany, Italy, Portugal). In parallel a smart charging simulation environment (digital twin of the charging chain with a holistic simulation environment with multilevel component models and representative information flow between all agents) will be built up. This digital twin will incorporate the results of the demonstration actions and enable an upscaling to show the impact of these technologies. To ensure the interoperability and the optimization along this charging chain, the consortium comprises all relevant partners/stakeholders (energy providers, grid operators, charge point operator, EV equipment providers as well a vehicle manufacturer).

Impact:

The operational, economic and environmental impacts (positive and negative) of V1G, V2G and V2X are evaluated to identify the solutions that are beneficial or disadvantageous for the system or society. These studies integrate and assess all the scenarios summarized in element e), which means that includes the detailed effects on the grid as charging vehicles on power lines, power substations, distribution grids, reactive power and power quality (element b), the assessment of additional costs for electronics to enable V2G, assessment of installation costs for charging infrastructure, optimizing the cost of on-vehicle and infrastructure-side electronics (element c), the operational assessment including assessing the impact of different bi-directional charging profiles on the life of the EV battery and power electronics as well as costs of battery damage and their lifespan (element d). These studies will be developed as a tool, developed following the framework of LCA methodologies, to facilitate their interoperability with the digital twins (element f), to support the scenario selection, e.g. the conditions in which V2X functionalities are needed and where V1G charge control is sufficient and to provide support to address the user needs (element a). All the impacts are evaluated according to the taxonomy regulation "Do Not Significant Harm". Based on all impact categories a list of recommendations for the deployment of V1G, V2G and V2X will be given.

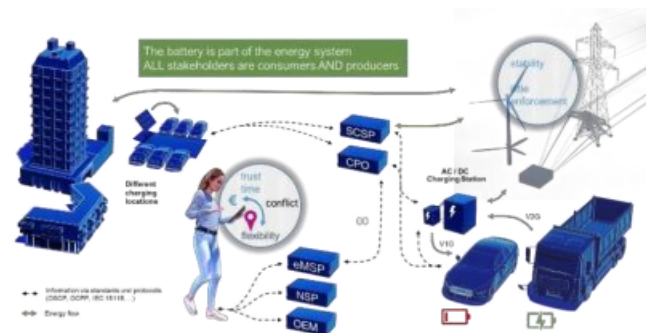



HORIZON-CL5-2021-D5-01-04: LCA and design for sustainable circularity - holistic approach for zero-emission mobility solutions and related battery value chain (ZZERO & Batteries Partnership)

[Back to projects' list](#)







TRANSENSUS LCA

Towards a European-wide harmonised transport-specific LCA Approach



TransSensus LCA strives for a Europe-wide harmonised, commonly accepted and applied single life cycle assessment (LCA) approach for a zero-emission road transport system.

From 01/2023 To 06/2025	Project total cost	EU contribution	Website
	4.03 M€	3.68 M€	www.lca4transport.eu

Technologies and services deployed	Project partners' countries
 Technologies for consumers  Grid technologies  Large-scale storage technologies  Distributed storage technologies  Generation technologies	<p>LCA</p> 

Coordinator Fraunhofer LBF & IST (Germany)

Other partners:

- BMW (Germany)
- BRGM (France)
- CEA (France)
- EDF (France)
- University Ghent (Belgium)
- University Leiden (Netherlands)
- Northvolt (Sweden)
- Renault (France)
- Ricardo (Germany)
- RWTH-Aachen – INAB (Germany)
- Scania (Sweden)
- Sphera (Germany)
- IVL (Sweden)
- TU Braunschweig (Germany)
- University Bordeaux (Germany)
- Volkswagen (Germany)
- Umicore (Belgium)
- Valeo (France)
- ST Microelectronics (France)

Associated Partners:

- Ricardo (UK)
- Ecoinvent (Switzerland)
- University College Dublin (Ireland)
- CLEPA (Belgium)
- ECTRI (Belgium)
- University Firenze (Italy)
- PSA (France)
- AVL (Austria)
- Ford (Germany)
- Smart Freight Center (Netherlands)
- EURIC (Belgium)
- RECHARGE (Belgium)
- Toyota Motor Europe (Belgium)
- Öko-Institut (Germany)
- IFPEN (France)
- European Lithium Institute (Belgium)
- IVECO (Italy)
- Fiat (Italy)
- Siemens (Germany)
- Volvo Technology (Sweden)Siemens (Germany)
- Everledger (UK)
- ERTICO (Belgium)
- Tecnalía (Spain)



Project Description

Context. Our road transport system is rapidly transforming in response to climate change and resulting demand for a high sustainability over the full value chain and the full life cycle. New propulsion systems are achieving steadily increasing market shares, and new infrastructures and mobility concepts will be needed for connected and auto-mated vehicles, as well as to achieve the vision of smart and climate-neutral cities. In order to define realistic sustainability goals – for all stakeholders in the mobility sector – and to select the most sustainable solutions, the environmental, economic and social impact of technologies and mobility concepts must be assessed and continuously monitored in a holistic way.

Scope. TranSensus LCA aims to develop a baseline for a European-wide harmonised, commonly accepted and applied single life cycle assessment (LCA) approach for a zero-emission road transport system. Such a European single LCA approach is seen as a key element in achieving the Green Deal targets, making Europe the first digitally enabled circular, climate-neutral and sustainable economy. Bringing together relevant stakeholders from industry and research, an evidence- and real-life data-based LCA approach will be conceptualised and harmonised embracing environmental, economic and social aspects. By consensus.

- Conceptualise and demonstrate a single, European-wide real-data LCA approach for zero-emission road transport
- Harmonisation of methodologies, tools and datasets
- Elaborate an ontology and framework for a European-wide LCI database
- Conceptualise LCI data management and update along the life cycle and along the supply chain
- upcoming technologies and demands.
- Paving the way for LCA-based product and business development

Technical description and implementation

The conceptual approach for a consensus LCA will be elaborated within the consortium (considering retrospective and prospective assessment of vehicles and battery value chains. Furthermore, the demands and requirements of a circular economy, social aspects (S-LCA) as well as LCC or total cost of ownership will be considered where relevant. The conceptualization will be based on available and ongoing activities beyond TranSensus LCA and along the different life cycle stages and assessment steps. The building blocks of a single, European-wide LCA will be elaborated defining the perimeter the objective and applications of the approach. Furthermore, data ontology, fore-ground and background LCI data modelling, recommendations to enable fair comparisons, and circular value chains will be considered. Several tests of the holistic approach will be conducted in order to make sure gaps are sufficiently covered, to characterise remaining gaps and to test the feasibility and applicability of the approach.

Once a sufficient maturity of concept is reached, a harmonisation and consensus will be sought with all relevant stakeholders of the road transport community, including industry along the respective value chains, mobility providers and planners, standardisation bodies, legislators and the EC. Besides, synergies with and transfer to non-road markets such as other transport modes, general mechanical engineering or consumer products will be analysed.

Impact. Replicability: TranSensus LCA leads the way to transparency within the mobility sector enabling a prospective assessment as part of the product development or design of mobility solutions. By further assessing the use of the approach in other sectors, TranSensus LCA aims to join efforts with other sectors to harmonise the use of life-cycle methods and tools.

Socio-economics: An evidence-based, transparent single European-wide approach for assessing environmental impacts enables an efficient information of a product sustainability (better consumer information and out-line of benefits) lowering the threshold for consumers to choose zero-emission mobility solutions and offering an objective comparison of potential choices.

Environment: TranSensus LCA clearly contributes to the Sustainable Development Goals (SDG) on sustainable cities and communities (SDG 11), responsible consumption and production (SDG 12) and climate action (SDG 13).

Market Transformation: A transparent, comparable and evidence-based single LCA approach embracing environmental, economic and social aspects encourage industry to implement the assessment in early stages of product development. Thus, industry becomes better able to provide more sustainable and mobility scenario optimised products with lower TCO. A lower TCO leads also to an increased user acceptance and accelerated uptake of zero-emission solutions.

Policy: Ensuring the comparability and reliability of lifecycle assessments will lead to better informed policies and eco-design strategies that aim to further reduce the environmental impact of the sectors and contribute to the achievement of the EU's policy goal towards net-zero greenhouse gas (GHG) emissions and reduced air pollutants by 2050.



HORIZON-CL5-2022-D3-01-02: Demonstration of innovative materials, supply cycles, recycling technologies to increase the overall circularity of wind energy technology and to reduce the primary use of critical raw materials

[Back to projects' list](#)







Blades2Build

RECYCLE, REPURPOSE AND REUSE END-OF-LIFE WIND BLADE COMPOSITES – A COUPLED PRE- AND CO-PROCESSING DEMONSTRATION PLANT



The general scope of the proposed project is to evaluate and demonstrate in large scale the possibility of recycling or resource recovery from blades and similar waste materials in a large consortium with some of Europe's key players in areas of importance for the project.

From Jan 2023	Project total cost	EU contribution	Website
To Dec 2025	15.49 M€	12.36 M€	https://blades2build.com/

Technologies and services deployed	Project partners' countries
<ul style="list-style-type: none">  Technologies for consumers  Grid technologies  Large-scale storage technologies  Distributed storage technologies  Generation technologies 	<p>Wind Turbine Recycling demonstration plant for EoL windmill blades</p> 

Coordinator	DTU (DK)
--------------------	-----------------

Other partners:

- ACC (ES)
- HIC (FR)
- LM (DK)
- NTUA (EL)
- TU/e (NL)
- RWTH (DE)
- RENAO (TR)
- CESP (ES)
- ENDESA (ES)
- PZE (ES)
- GE Wind (DE)
- GCS (NO)
- ELDAN (DK)



Project Description

Context. The EU is facing a significant restructuring of Renewable Energy Sources (RES) to achieve climate neutrality goals by 2050. In this conversion phase, wind energy is one popular and applicable RES. Wind Europe expects that European wind energy generation will expand from 200 GW to 2,300 GW in the following 30 years by using larger and more resistant blade structures (the capacity of wind turbines will increase from 5-10 MW to over 25 MW). At the Wind Europe event in Bilbao in April 2022, it was announced that due to the current geopolitical situation in Ukraine, this transition from fossil fuels to wind energy will be accelerated. This radical conversion to wind energy will lead to major challenges for the industry regarding affordability, security, sustainability, and efficiency.

Scope. Blades2Build's aim is to improve and support circularity options of EOL wind blades by exploring three different circular stages – the BLADES2BUILD route (Figure):

- Direct re-use of the EOL wind blades with minimal refurbishment or processing (R4);
- Re-purpose of individual materials constituents of the blades (and wind blade manufacturing waste) in other uses/products, specifically in construction materials, with use in concrete and asphalt mixtures as the first option, creating 'circular products' (R7); and
- Recycling the blade and glass fibre textiles scraps from the wind blade manufacturing in cement/clinker co-processing as an alternative fuel (R8).

Technical description and implementation.

BLADES2BUILD aims at a thorough and detailed characterisation of the EOL blades and suggests a pre-treatment pathway for the specific materials in the composite waste. It also considers how to separate the materials into recoverable or recyclable fractions.

Impact.

Socio-economics:

- Generation of additional job opportunities at local levels after proposed processing line set-up. It is estimated that every 10,000 tons of recycled waste create more than 100 new jobs.
- Increase the institutional capacities of researchers, industrial players and governments by using the proposed frameworks and outputs of the project via well-designed knowledge hub activities

Environment: BLADES2BUILD adds to the effort of making clean(er) renewable energy in a climate-friendly way, in line with our world's net-zero urgency to keep global warming within 1.5°C. Reaching an 85% material recycling rate across our economy would reduce CO₂ emissions by up to 50 billion tons. Reaching Nature is positive with regenerative business models that will increasingly substitute resources drawn from nature with recycled materials, thus preserving biodiversity and reducing water use. The list below summarizes more environmental benefits:

- Improvement of soil/water/air qualities by reducing the landfilling operations.
- Reduction of the dust and other hazardous gases generated during recycling processes by proposing closed systems.
- Replacement of virgin materials by recycled materials to eliminate excess emissions and carbon footprint that occur during the manufacturing of virgin ones as well as reducing the usage of natural resources.
- Significant reduction of waste volumes by applying recycling, re-using and re-purposing systems.
- Reduction of GHG emissions caused in transportation, processing and manufacturing processes studying the best option in terms of emissions: a mobile processing lines vs. a fixed plant.
- Reduction of GHG emissions during the cement production due to the co-processing of the waste and the fossil fuel by proposing new innovative products.

Market Transformation: After setting up comprehensive business scenarios in which detailed business models and sensitivity analysis will be given to highlight critical positions of affordable, secure and sustainable recycling technologies and services by improving their competitiveness in global value chains and their positions in growth markets for the reuse of recycled carbon/glass fibres in cement manufacturing, as well as testing and analysis of large-scale alternative recycling systems from aspects of technical design and operational limitations to increase efficiency and reduce material handling and operating costs, expected contributions can be summarised as below:

- Increase the collected volumes of carbon/glass fibres and their qualities from a unit EOL Blade at a large-scale pilot facility.
- Reduction of logistics/material handling costs of EOL blades in recycling operations (by proposing on-site processing systems).
- Reduction of operational costs (e.g. energy, fuel, supplementary materials, etc.) by tuning up technical constraints of processing lines.
- Increase the efficiency rates of semi/final product (fibres) collection operations per a unit blade by adjusting some processing parameters.
- Reduction of raw material costs by using recycled fibres (innovative circular cement products) in cement manufacturing.
- Increase stakeholders' competitiveness levels and annual turnovers by using alternative innovative/green products produced from recycled composites



HORIZON-CL5-2022-D3-01-02: Demonstration of innovative materials, supply cycles, recycling technologies to increase the overall circularity of wind energy technology and to reduce the primary use of critical raw materials

[Back to projects' list](#)







EoLo-HUBs

Wind turbine blades End of Life through Open HUBs for circular materials in sustainable business models



A sustainable Circular Economy in the wind sector requires to solve the End of Life problematic of the Wind Turbine Blades, prioritizing environmental factors and fairly sharing the efforts to overcome the technologic, economic and social barriers among all the key actors. To this end, EoLo-HUBs will develop 3 open hubs to co-design, co-create and demonstrate new technologies, organizational structures, business models and legal recommendations to implement CE according to the needs of the different European regions.

From 01/01/2023 To 31/12/2026	Project total cost	EU contribution	Website
	12.1 M€	10.0 M€	www.eolo-hubs.eu

Technologies and services deployed	Project partners' countries
 Technologies for consumers  Grid technologies  Large-scale storage technologies  Distributed storage technologies  Generation technologies	<p>Demand response</p>  <p>Wind turbines</p>

Coordinator FUNDACION AITIIP (Spain)

Other partners:

- ECHT regie in transitie B.V (Netherlands)
- NORDEX ENERGY GMBH (Germany)
- MOSES PRODUCTOS SL (Spain)
- MITSUBISHI CHEMICAL ADVANCED MATERIALS GMBH (Germany)
- CONSORCIO AERODROMO AEROPUERTO DE TERUEL (Spain)
- ADVANTIS APS (Denmark)
- FRAUNHOFER GESELLSCHAFT ZUR FORDERUNG DER ANGEWANDTEN FORSCHUNG EV (Germany)
- JANSEN RECYCLING GROUP B.V (Netherlands)
- MONDRAGON GOI ESKOLA POLITEKNIKOA JOSE MARIA ARIZMENDIARRIETA S COOP (Spain)
- SAINT-GOBAIN PLACO IBERICA SA (Spain)
- GLOBAL EQUITY & CORPORATE CONSULTING SL (Spain)
- NEDERLANDSE ORGANISATIE VOOR TOEGEPAST NATUURWETENSCHAPPELIJK ONDERZOEK TNO (Netherlands)
- CENTRO RICERCHES FIAT SCPA (Italy)
- POLYMERIS (France)
- NCC OPERATIONS LIMITED (UK)
- UNIVERSITY OF LEEDS (UK)
- THE MANUFACTURING TECHNOLOGY CENTRE LIMITED (UK)



Project Description

Context

Europe is among the global leaders in wind energy technology accounting for more than 70% of all wind power installed in the world. This meets nearly 14% of the EU's power demand, being the second largest form of power generation capacity in the EU-28. The huge growth that wind energy has experienced in Europe since the 90's is starting to pose some environmental problems associated to the challenges of the end-of-life management of those wind farms which have reached to the end of their useful life. A study carried out in 2016 showed that 12% of the installed wind turbine capacity in Europe is older than 15 years and would soon reach the end of its designated service (20-25 years) reaching a share of 28% by 2020.

Scope

Wind turbines are made of a combination of different materials, such as wood, metals, adhesives, coatings and fibre-reinforced polymer (FRP), which can be made of glass (GFRP) or carbon (CFRP). Fiber glass is the primary structural material used in wind turbine blade manufacturing. More than 80% of the wind turbine installations deployed until 2015 was made of this material, although the presence of carbon fibre has risen due to the need of longer blades to achieve higher power outputs per wind turbine. The recycling of polymeric end of life (EoL) composite is very challenging, due to the heterogeneity of the FRP materials and the strong adhesion between the fibre reinforcement and the polymer matrix with the usual thermoset resins. Therefore, recycling FRP normally comes with the undesirable side-effect of "downgrading", ending as a raw material for low quality applications. Most of this EoL composite is currently landfilled or incinerated.

Technical description and implementation

EoLo HUBs project aims at demonstrating a novel cluster-based approach for the actual implementation of sustainable business models around the dismantling and recycling of end-of-life wind turbine blades (WTB). The project will demonstrate and validate a set of innovative composite material recycling technologies which will provide answer to the three main areas involved in the EoL wind farms recycling:

1. Decommissioning and pretreatment of WTB including: handling, NDT inspection, cutting, shredding, and sorting
2. Sustainable fibre reclamation processes addressing two alternative routes: Low carbon pyrolysis and green chemistry solvolysis and
3. Upgrading processes for the recovered fibres addressing Glass fibres (mainly) as well as carbon fibres. Furthermore, a knowledge hub will be set up by means of a digital platform providing the circular economy framework to enable the replication of the project approach for WTB recycling (i.e decision support tool to guide the new developments, cost-benefit analysis) and the realisation of the business agreements (i.e., providing

accurate data of the raw material through the material passport).

Impact

- Demonstrate recycling technologies at large-scale in an operating environment and uptake recycled composites from current and future wind turbine blades to increase circularity of wind technology. Develop resilient value chains for EU industries by reducing dependency on raw materials through circular use of resources, reducing waste and replacing critical raw materials (sourcing domestically when possible).
- Make sustainable composite products the standard by developing a Knowledge hub involving other composite-heavy sectors in order to share best practices, identify common challenges and contribute to the promotion of the 'circularity by design' approach in the wind energy sector. Make circularity work for people, regions and cities and lead global efforts in circular economy, fostering EU global leadership in renewable energy technologies. Empower consumers and public buyers.
- Demonstrate reduced carbon footprint on the wind turbine value chain. Achieve the goals of climate neutrality by 2050 by contributing to the supply of clean energy.

Replicability: Replicability is addressed in several tasks and foresees the creation of new circular hubs.

Socio-economics: Engage stakeholders to ensure market uptake of project results after its validation at large-scale demonstrators. Generating innovation-based growth. Creating more and better jobs.

Environment: Decrease the utilisation of virgin raw materials (recovering more than 2500 tonnes of material). Lower embedded CO₂ by reducing transport and energy demand. Decreased waste and pollution.

Market Transformation: Promote circular business models. Leveraging investment in research and innovation.

Policy: Addressing EU policy priorities





HORIZON-CL5-2022-D3-01-02: Demonstration of innovative materials, supply cycles, recycling technologies to increase the overall circularity of wind energy technology and to reduce the primary use of critical raw materials

[Back to projects' list](#)







REEFLEX

REplicable, interoperable, cross-sector solutions and Energy services for demand side FLEXibility markets



REEFLEX aims to generate niches of opportunities for new cross-sector energy services provided by SMEs and start-ups

From 01/01/2023	Project total cost	EU contribution	Website
To 31/12/2026	9.98 M€	8.2 M€	www.reeflexh2020.eu

Technologies and services deployed		Project partners' countries
	Technologies for consumers	
	Grid technologies	
	Market	
	Distributed storage technologies	
	Generation technologies	
	Demand response Smart appliances NILM techniques for load disaggregation Flexibility potential classification for any given asset Optimal management of the grid Predictive flexibility potential and operation of distributed devices Calculation of DSO flexibility needs Optimal market selection P2P and bilateral energy exchange trading Heat-pumps Second-life batteries & Innovative inverters for storage systems and electric vehicles (V2G) PV	

Coordinator	Fundación Circe Centro de Investigación de Recursos Y Consumos Energéticos (Spain)
--------------------	---

Other partners:

- Sistemas Urbanos de Energías Renovables SL (Spain)
- Sociedad Municipal Zaragoza Vivienda (Spain)
- Omi-Polo Español SA (Spain)
- Ethniko Kentro Erevnas Kai Technologikis Anaptyxis (Greece)
- Watt and Volt Anonimi Etairia Ekmetalleysis Enallaktikon Morfon Energeias (Greece)
- Kainotomia Idiotiki Kefalaiochiki Etaireia (Greece)
- Que Technologies Kefalaiochiki Etaireia (Greece)
- Ubitech Limited (Belgium)
- Yugoiztochnoevropyska Tehnologichna Kompania Ood (Bulgaria)
- Abilix Soft Ltd (Bulgaria)
- University of Piraeus Research Center (Greece)
- Suite5 Data Intelligence Solutions Limited (Belgium)
- Enerbrain Srl (Italy)
- Betteries Amps GmbH (Germany)
- Arcelik A. S. (Turkey)
- Lietuvos Energetikos Institutas (Lithuania)
- Rina Consulting Spa (Italy)
- Fundación Cartif (Spain)
- Smart Innovation Norway (Norway)
- Temsa Skoda Sabanci Ulasim Araclarianonim Sirketi (Turkey)
- Holbæk Kommune (Denmark)
- Smart Energy Lab - Association (Portugal)
- Edp Centre for New energy Technologies (Portugal)
- Azienda Elettrica di Massagno SA (Switzerland)
- Hive Power Sagl (Switzerland)
- Scuola Universitaria Professionale Della Svizzera Italiana (Switzerland)



Project Description

Context. REEFLEX is focused on delivering higher participation of energy consumers in demand side flexibility markets and demonstrating niches of opportunities for new services provided by SMEs and start-ups, seeing a growing number of distributed energy resources (DERs) connected to the network.

These DERs come from an ample variety of energy carriers and sectors, accompanied by the introduction of new digitalized assets. This decentralization poses significant challenges for the resilience of the system, and uncertainty in traditional control routines.

To ensure replicability of REEFLEX solutions, they will be demonstrated and cross-tested in 4 main demonstrators (Spain, Greece, Switzerland, Bulgaria). The services catalogue will be further replicated in three additional replicators to achieve wider coverage (Turkey, Portugal, Denmark).

Scope. REEFLEX’s main scope is to develop a set of viable interoperable solutions and services that increase the participation of energy consumers in demand side flexibility (DSF) markets. Additionally, it will:

- develop a catalogue of bespoke flexibility services and interoperable tools for specific consumer groups.
- develop a services central platform and energy marketplace, reducing entry barriers and transaction cost
- unify technical, sustainability, environmental, economic, and social parameters, ensuring that privacy, cybersecurity and data management issues are properly managed.
- classify all assets installed within the grid according to their flexibility potential and SRI, enhancing them with interoperability capabilities.
- carry out a demonstration program up to TRL7 in 4 main demonstration sites with cross-replication covering different energy vectors.
- explore full replication potential of solutions considering cost-benefit analysis in 3 additional replicators.

Technical description and implementation. REEFLEX work will be developed in 3 main directions:

- Development of a central platform, REEFLEX Platform, enabling the connection and interoperability of all devices, accounting for synergetic, cross-sectoral networks, improving data secure and privacy exchange through these assets
- Mobilizing demand response and new services thanks to the standardization of smart assets connected market transfer through IoT and the development of a set of solutions aiming at achieving optimal management of microgrids in accordance to end users’ demands
- Establishing easy connections to any flexibility markets (local, national or european), reducing entry barriers and transaction costs.

Impact. Replicability: REEFLEX will be replicated in 3 different countries and demonstrated up to TRL 7 in 4 main demonstration sites with cross-replication covering different energy vectors, covering 7 countries overall to ensure replicability and scalability of the project results.

Socio-economics: The generation of a common operation market model together with AI-driven intelligence services and automation systems, enabled through the utilization of DLT technologies (blockchain) will reduce market entry barriers and costs and achieve a higher participation from energy consumers. They will benefit from new revenues obtained through data and flexibility transactions.

Environment: By accounting real time and synthetic data derived from power flow analysis, REEFLEX will provide both environmental and economic benefits by grouping together prosumers with same needs and characteristics, directly targeting platform users to increase economic profits, minimize emissions, decarbonize environment and decrease CO2 footprint

Market Transformation: REEFLEX will allow to determine end-user’s potential flexibility and aggregation by calculating their capacities to offer flexibility and their cost, their capacity to increase or decrease their consumption or even provide energy to the grid in different time horizons, which will led to a better RES and storage facilities better and extended use.

This will result in an optimal market selection tool, which will provide the platform with an array of expected scenarios of the flexibility markets, arranged by probability, and the forecasted price trends, making it possible to apply the most convenient decisions in terms of energy use and optimal flexibility market bidding.

Policy: Through the proper tasks, REEFLEX will deliver policy recommendations to align the main outputs with upcoming legislation on sustainable smart grids and recommendations on standards and certifications to ensure the flexible integration and interoperability of DERs.





HORIZON-CL5-2022-D3-01-02: Demonstration of innovative materials, supply cycles, recycling technologies to increase the overall circularity of wind energy technology and to reduce the primary use of critical raw materials

[Back to projects' list](#)

REFRESH

Smart dismantling, sorting and REcycling of glass Fibre Reinforced composite from wind power Sector through Holistic approach



REFRESH aims to develop and demonstrate a novel circular, smart system for an improved recycling (>90%) of glass fiber-reinforced composites derived from wind turbine dismantling or reblading, with high purity level. The project will focus on the mechanical and thermal treatment of waste, but it will strongly involve the entire reverse circular value chain: from end-of-life blades to a wide range of re-manufactured products. REFRESH proposes a flexible re-manufacturing line: when a wind-blade is decommissioned, it will be performed a selection of optimal recycling process according to the technical condition of the blade and current market demand; this will be achieved by using a dedicated tracking tool for collecting, protecting and sharing information and an embedded decision-making tool software for selecting time by time the most sustainable approach to recycling.

From 01/01/2023

Project total cost

EU contribution

Website

To 31/12/2026

15.52 M€

11.46 M€

TBD

Technologies and services deployed

Project partners' countries



Technologies for consumers

Automation, technological upgrading, innovation
Sorting, recycling and production technologies enabling the development of environmentally sound end-products.



Grid technologies

Design of circular materials, tracking of products through value chains, towards recycling and reuse



Coordinator

RINA-C (Italy)

Other partners:

- ACCIONA (Spain)
- CETMA (Italy)
- CIRCE (Spain)
- Gees Recycling (Italy)
- TECNALIA (Spain)
- MTB MANUFACTURING (France)
- ENECOLAB S.R.L. (Italy)
- GJENKRAFT (Norway)
- STD FRANCE (France)
- EUCIA (Belgium)



Project Description

Context

REFRESH aims to develop and demonstrate a novel circular, smart system for an improved recycling (>90%) of glass fiber-reinforced composites derived from wind turbine dismantling or reblading, with high purity level. The project will focus on the mechanical and thermal treatment of waste, but it will strongly involve the entire reverse circular value chain: from end-of-life blades to a wide range of re-manufactured products.

Scope

- Development of large-scale industrial demonstration of composite material recycling technologies to increase the circularity of wind technology.
- To develop a flexible production line, able to deal with a large amount of materials and applicable to several manufacturers and possibly to other sectors.

Technical description and implementation

REFRESH will mainly focus on technology solution development, prototyping and demonstration activities aiming to overcome the current technological gaps and uncertainties found at the End of Life stage for wind blades.

- New advanced dismantling and sorting technologies
- New recycling technologies and production processes for secondary raw materials
- Deployment of REFRESH Technologies
- Develop an advanced smart tool for traceability.

Impact

Replicability: The REFRESH project targets the recovery of composites from wind blades, opening the door to a huge resource and replicability potential.

Socio-economics: Contribution to key social European Policies and Initiatives, new job creation, creation of novel Business models, impact on other sectors beside wind energy.

Environment: sustainable economic activity with resources savings or uses, which works towards circular economy and eco-design strategy.



HORIZON-CL5-2022-D3-01-07: Demonstration of innovative rotor, blades and control systems for tidal energy devices

[Back to projects' list](#)







MAXBlade

Maximising tidal energy generation through Blade Scaling & Advanced Digital Engineering



The MAXBlade project will specifically focus on delivering a 70% increase in rotor swept area of the technology by addressing design, reliability, condition monitoring, maintenance and control issues relating to tidal turbine blades.

From 2023	Project total cost	EU contribution	Website
To 2028	10.1 M€	1.3 M€	TBD

Technologies and services deployed		Project partners' countries
	Technologies for consumers	
	Grid technologies	
	Large-scale storage technologies	
	Distributed storage technologies	
	Generation technologies	
Coordinator	TECHNIPFMC (Poland)	

Other partners:

- MARASOFT B.V. (THE NETHERLANDS)
- FUNDACION TECNALIA RESEARCH & INNOVATION (SPAIN)
- BELGISCH LABORATORIUM VANELEKTRICITEITSINDUSTRIE (BELGIUM)
- ASSOCIATION EUROPEENNE DE LINDUSTRIE DES COMPOSITES (BELGIUM)
- THE EUROPEAN MARINE ENERGY CENTRE LIMITED (UNITED KINGDOM)
- THE UNIVERSITY OF EDINBURGH (UNITED KINGDOM)
- ORBITAL MARINE POWER LIMITED (UNITED KINGDOM)



Project Description

Context. The MAXBlade project will specifically focus on delivering a 70% increase in rotor swept area of the technology by addressing design, reliability, condition monitoring, maintenance and control issues relating to tidal turbine blades. All of these issues have to date been insufficiently addressed for tidal turbine blades and need to be holistically tackled to reach a site-averaged €30/MWh cost reduction in tidal stream energy, while maturing the technology to address barriers around investment attractiveness. The project also anticipates significant challenges and expected legislative requirements around applying circular economy principles to tidal stream turbine blades in pursuit of a net zero generation sector. With a close interface between blade design and testing activities, the project addresses a comprehensive circular economy roadmap for tidal turbine blades, including advancing the potential of recyclable thermoplastic resins for use in the composite blades. The project also progresses initiatives to ensure that the European composite sectors become the international leader in tidal blade manufacture through knowledge transfer, practical engagement in the blade production design and identifying and addressing barriers to increasing European supplier capacity.

Scope. The project will consist of a 2-year design and development phase, an 18-month build, followed by a 2-year performance verification through the build of a tidal array of at least two units (ca. 5MW), ensuring that 8 blades (4 rotors) are tested providing cumulatively 120,000 hours of rotor performance data.

Technical description and implementation. There is 10GW of predictable, high value tidal stream potential in European waters, with up to 100 GW of capacity globally. It is an entirely unharnessed resource, with just 13 MW currently deployed.

Orbital Marine Power (one of Consortium Participant) is the world's leading developer and technology owner of floating tidal stream energy systems. Over the past 18 years the development covered engineering (including blade engineering) and offshore operations knowledge and experience, intellectual property, models and simulations towards the development of floating tidal stream energy.

The project aims to deliver essential blade and rotor innovations and initiatives to improve performance, reduce cost, increase reliability, survivability, recyclability and finance ability which in turn will enable the tidal sector to make significant contributions towards Europe's energy systems, energy security and industrial development by 2030 and beyond to 2050. The project has six specific objectives:

1. Deliver reliable, cost optimised and customisable 13m tidal turbine blades to maximise project yield,
2. Develop and implement advanced tidal blade structural condition monitoring to increase turbine availability
3. Deliver reliable control inputs and optimal

blade/controller designs to maximise array level power performance

4. Enable circularity in tidal turbine blades including recyclable thermoplastic manufacturing
 5. Secure European leadership of tidal turbine composite blade manufacturing with competitive 320 tidal blade per annum capacity by 2036. Advance integrated digital maintenance management of tidal arrays.
- Overall, a 20% generation cost reduction from €150/MWh to €120/MWh is targeted.

Impact. Replicability: MAXBlade project focuses on tidal technology development and obtaining the maturity level allowing implementation in large scale. The project scalability and flexibility highlights the attractiveness of developed solution.

Socio-economics: MAXBlade will significantly support European supply chain solution for tidal stream energy with low leakage rates enabling the European manufacturers to deliver blades and tidal turbines. It will have a positive impact on the creation of new workplaces in power system sector.

Environment: MAXBlade positively contributes to increasing of renewable energy utilisation having large impact on the efficiency of energy production. Moreover, it enables the access to cheaper and sustainable energy for European consumers.

Market Transformation: MAXBlade project will enable market transformation allowing on utilisation of tidal stream energy. It will be great step in the development of renewable energy sources sector.

Policy: MAXBlade project will significantly support European policy of Renewable Energy Sources, Green Energy, the decrease of electricity prices, flexibility and security of power supply, stability of European Power System.

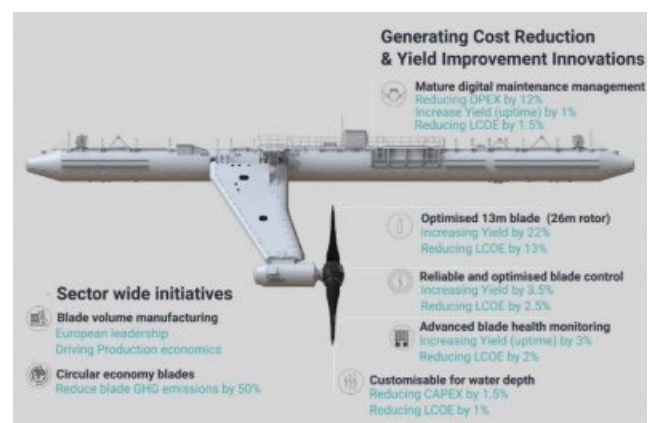



HORIZON-CL5-2022-D3-01-08: Supporting the action of consumers in the energy market and guide them to act as prosumers, communities and other active forms of active participation in the energy activities

[Back to projects' list](#)



MASTERPIECE

Multidisciplinary Approaches and Software Technologies for Engagement, Recruitment and Participation in Innovative Energy Communities in Europe



MASTERPIECE aims at creating a digital coordination and cooperation modular platform of services that will facilitate the creation and operation of energy communities. The facilities given to members of the community to contribute to services and other developments will represent the distinction of the solution offered in this proposal, making it participative by design.

From 2023	Project total cost	EU contribution	Website
To 30/06/2026	6.985.509 € 1.042.500 CHF	5.996.628 € 745.585 CHF	https://masterpiece-horizon.eu/

Technologies and services deployed		Project partners' countries
 Technologies for consumers	Demand response EVs	
 Grid technologies	Demand response Energy Communities	
 Large-scale storage technologies	Flexibility Transparency	
 Distributed storage technologies	Prosumers	
 Generation technologies	Demand response EVs	

Coordinator UNIVERSIDAD DE MURCIA (Spain)

Other partners:

- ALGOWATT SPA (Italy)
- UNIVERSIDAD DE MURCIA (Spain)
- ETHNIKO KENTRO EREVNAS KAI TECHNOLOGIKIS ANAPTYXIS (Greece)
- R2M SOLUTION S.R.L. (Italy)
- ODIN SOLUTIONS S.L. (Spain)
- EXPERIENTIA GLOBAL SA (Switzerland)
- TROYA CEVRE DERNEGI (Turkey)
- ULUDAG ELEKTRIK DAGITIM A.S. (Turkey)
- UNIVERSITA' COMMERCIALE LUIGI BOCCONI (Italy)
- SUSTAINABLEINNOVATION I SVERIGE AB (Sweden)
- UNIVERSITE D'AIX MARSEILLE (France)
- RDIUP (France)
- ACEA PRODUZIONE SPA (Italy)
- GRID ABILITY SCARL (Italy)
- NGENIC AB (Sweden)
- UPPSALA KOMMUN (Sweden)
- AGENCE LOCALE DE L'ENERGIE ET DU CLIMAT - MÉTROPOLE
- BORDELAISE ET GIRONDE – ALEC (France)
- COMUNE DI BERCHIDDA (Italy)
- PLATE-FORME EFFICACITÉ ÉNERGÉTIQUE SEINE AVAL SEINERGY LAB (France)



Project Description

Context. The energy ecosystem needs to transform fast in the direction of rethinking the way energy is used and managed. Electricity is becoming more common as an energy carrier even in countries where gas has traditionally been the main source of energy.

Despite the move towards more efficient houses, occupants will continue needing energy.

This situation, together with the fact that the electrical grid will have to keep absorbing electro-mobility, leads to a strain on the electrical grid, particularly if the loads are not properly managed.

With buildings accounting for over 40% of the total consumption in developed countries and being the energy used in road transport similar to that used in the residential sector, one can expect difficulties in managing the following 2 challenges:

1. not overloading the grid
2. making sure that the European Energy System is capable of providing reliable affordable energy for everybody.

Scope

- To develop technical and social innovations to empower traditional energy consumers and to make them active agents of collaborative energy communities, paving the way toward a new energy market paradigm.
- To create user-centric solutions that are based on participatory approaches such as co-creation and naturally accelerate citizens' involvement.
- To propose new business strategies and incentive mechanisms that activate the reactions of market participants craving for business opportunities that imply energy use and cost reduction.
- To configure a standardised and sound cyber-security infrastructure so the active citizens are protected against cyber-attacks, at the same time that privacy is defended in accordance with the revised EPBD and the GDPR law.
- To demonstrate the applicability and replicability of methodological, technical, and business innovations in a variety of real-life pilots in different geographical locations, with heterogeneous social and economic environments and different regulatory/administrative frameworks.

Technical description and implementation.

- Nudging participation in energy communities through automation.
- Boosting self-determinacy in communities' energy management through the Artificial Intelligence toolbox
- Facilitating the connectivity of community members to monitor energy flows.
- Modifying demand response at the community and citizen level.
- Expanding energy business against fuel poverty to include philanthropic prosumers.

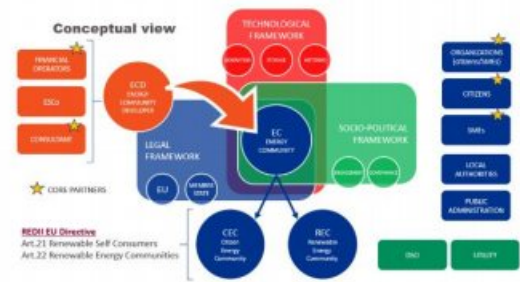

Impact. Replicability: The Intervention Program, designed with the participants of the energy communities of the pilot sites, constitutes a project asset and will lay the foundations for the validation of intervention and acceleration models on a very large scale (up to 1000 and more energy communities).

Socio-economics: Demonstration of real-life interactive tools to engage citizens in the energy transition and to support them throughout the process of generating, developing, and expanding energy communities in a structured journey fine-tuned through field tests.

Environment: the assessment of the 5 hubs of energy communities will produce new evidence on how to nudge the onboarding of more citizens in energy communities and how to boost adherence to the vision and mission of the communities. Qualitative insights will frame the modelling of energy communities' resources and tools to foster participation, agency, literacy, and social entrepreneurship.

Market Transformation: More effective market uptake of renewable energy and fuel technologies.

Enhance consumer satisfaction and increase system flexibility by enabling consumers to benefit from data-driven energy services and facilitating their investment and engagement in the energy transition, through self-consumption, demand response, or joint investments in renewables.

Policy: MASTERPIECE aims to integrate SSH disciplines to support interdisciplinary research, and policymaking in the energy field and contribute to Europe's visions and goals set by the EU Green Deal.



ORIZON-CL5-2022-D3-01-08 - Supporting the action of consumers in the energy market and guide them to act as prosumers, communities and other active forms of active participation in the energy activities

[Back to projects' list](#)

RESCHOOL

Strategies and t00ls for Incentivization and management of flexibility in Energy Communities with distributed Resources



The main objective of RESCHOOL is to catalyse the creation, growth and management of energy communities by leveraging the engagement of participants, facilitating the cooperation in collaborative initiatives within communities, and co-producing tools for the efficient management of energy and trading at individual and aggregated levels.

From 2023	Project total cost	EU contribution	Website
To 30/06/2026	6.1 M€	5.6 M€	https://www.reschool-project.eu/

Technologies and services deployed		Project partners' countries
	Technologies for consumers	
	Grid technologies	
	Large-scale storage technologies	
	Distributed storage technologies	
	Generation technologies	
	Market	
	Demand response Smart metering Network management, monitoring and control tools Micro-grid	
	Batteries Electric Vehicles	
	PV	
	Ancillary Services	

Coordinator UNIVERSITAT DE GIRONA (Spain)

Other partners:

- UNIVERSITETET I STAVANGER (Norway)
- UNIVERSITEIT UTRECHT (Netherlands)
- BAMBOO ENERGY PLATFORM SL (Spain)
- RISE RESEARCH INSTITUTES OF SWEDEN AB (Sweden)
- EUROPEAN RENEWABLE ENERGIES FEDERATION-FEDERATION EUROPEENNE DES ENERGIES RENOUVELABLES (Belgium)
- EUROPEAN SCIENCE COMMUNICATION INSTITUTE (ESCI) GGMBH (Germany)
- KMO ENERGY SL (Spain)
- NIESING HUGO (Netherlands)
- ELECTRICITY INNOVATION EKONOMISK FORENING (Sweden)
- ENERGEIAKI KOINOTITA PERIORISMENIS EVTHINIS (Greece)
- ETHNIKO KENTRO EREVNAS KAI TECHNOLOGIKIS ANAPTYXIS (Greece)
- INNOHUB BV (Netherlands)
- GEMEENTE AMSTERDAM (Netherlands)
- DIPUTACION DE GERONA (Spain)
- LOCALLIFE SWEDEN AB (Sweden)



Project Description

Context. Currently, the energy sector is responsible for 72% of the EU’s GHG emissions. Reaching the sustainability targets negotiated under the Green Deal requires facing the green transition towards clean energy by increasing the renewable share and efficient use of energy. Despite the impacts on the energy production, responsibility falls on citizens and governors. An effective energy transition requires urgent actions on empowering consumers, enabling demand-side flexibility, and promoting new roles such as prosumers, aggregators, and energy communities.

Scope. RESCHOOL envisions learning communities as vital in enabling citizens to participate in a shared socio-technical imaginary of user-centred, sustainable and affordable energy systems. It aims to tackle key socio-technical challenges related to the energy transition.

Technical description and implementation.

RESCHOOL aims to increase the active participation of communities in energy markets, enhancing and facilitating the management and trading of flexibility in cooperation with sectoral players, like DSOs and aggregators. To achieve this objective, the following technical (T), operational (OP) and socio-economic (S) objectives have been defined:

- To increase the citizens’ awareness and responsiveness of energy uses at household and community level through gamification strategies (S, T)
- Propose an interoperable architecture supported by a data model for the management of energy communities with aggregated interaction with flexibility markets (T)
- Develop a suite of services to support energy management and trading in energy communities, ready for integration and interoperability with third party solutions (T)
- Provide an open collaborative solution with access to individual and aggregated energy data and capabilities to interact with legacy systems and third-party solutions in a secure and safe way. (T)
- Validate a complete solution for the management of energy communities ready to operate with both, flexibility markets and behind the meter (legacy) systems. (T)
- Elaborate a blueprint for the creation, development and sustainable management of energy communities including flexibility services. (S, OP)
- Elaborate the guidelines and recommendations for the further replicability and exploitation of the developed tools and citizen engagement strategies. (S)

Impact. Replicability: A heterogeneous group of 4 pilots will be deployed in 4 different countries (Spain, Netherlands, Sweden and Greece). These countries have been selected to cover a broad range of energy behaviours consumers/prosumers and Energy Communities maturity, grid typologies and distinct regulatory environments. Replicability studies have been considered for all the

pilots. In the Spanish pilot the province of Girona will spread the experience in more than 90 municipalities, the City of Amsterdam aims to replicate specific use cases over the city. In Greece, RESCHOOL has the links with associations and cooperatives interested in the results; and in Stockholm, in collaboration with the municipality, the project has access to housing associations that will follow the project execution.

Socio-economics: RESCHOOL, will deeply analyse economic viability of energy communities and explore business models based on the valorisation of different dimensions: grid interaction (reduction of transmission losses, demand response, deferral of investment, congestion avoidance, peak reduction, EV charging strategies); energy community management (energy savings, generation revenues, efficiency, etc.) and valorisation of social dimension and influence capability.

Environment: RESCHOOL tools will led to the optimization of the energy usage for the members of the community in order to advance towards more sustainable energy generation and consumption modes that contribute to environmental targets such as reduced CO2 emissions. (SDG 7 and SDG 11)

Market Transformation: RESCHOOL wants to facilitate the collective participation of citizens in the energy system by facilitating both automated flexibility management and aggregation and digital access to interact with other energy stakeholders in the energy value chain (i.e. aggregators, DSOs, Markets, ESCOs, etc.) leveraging citizens as new players of the energy market.

Policy: RESCHOOL will analyse framework conditions to provide advice for policy and legal reform, that can prepare and facilitate the establishment of energy communities at larger scale and be presented to EU level decision-makers.





HORIZON-CL5-2022-D3-01-08 – Supporting the actions of consumers in the energy market and guide them to act as prosumers, communities and other active forms of active participation in the energy activities

[Back to projects' list](#)

COMMUNITAS

Bound to accelerate the roll-out and expansion of Energy Communities and empower consumers as fully-fledged energy market players



COMMUNITAS aims to support citizens to become active participants in energy activities and deliver a set of tools to support the creation, growth, and capacity building of Energy Communities.

From 2023	Project total cost	EU contribution	Website
To 30/06/2026	7.002.540 €	5.999.602,50 €	http://communitas-project.eu/

Technologies and services deployed		Project partners' countries
	Technologies for consumers	
	Grid technologies	
	Large-scale storage technologies	
	Distributed storage technologies	
	Generation technologies	
	Demand response Smart metering Network management, monitoring and control tools Microgrids	
	Batteries	
	Micro-generation PV and Wind turbines	

Coordinator EDP Labelec (Portugal)

Other partners:

- SMART ENERGY LAB - ASSOCIATION (Portugal)
- UNINOVA-INSTITUTO DE DESENVOLVIMENTO DE NOVAS TECNOLOGIAS-ASSOCIACAO (Portugal)
- UNIVERSIDADE NOVA DE LISBOA (Portugal)
- ETRA INVESTIGACION Y DESARROLLO SA (Spain)
- COOPERATIVA ELECTRICA BENEFICA SAN FRANCISCO DE ASIS SOCIEDAD COOPERATIVA VALENCIANA (Spain)
- RINA CONSULTING SPA (Italy)
- AZIENDA CONSORZIALE SERVIZI MUNICIPALIZZATI SPA (Italy)
- FONDAZIONE BRUNO KESSLER (Italy)
- ENERGY@WORK SOCIETA' COOPERATIVA A R.L. (Italy)
- ETHNIKO KENTRO EREVNAS KAI TECHNOLOGIKIS ANAPTYXIS (Greece)
- WATT AND VOLT ANONIMI ETAIRIA EKMETALLEYSIS ENALLAKTIKON MORFON ENERGEIAS (Greece)
- EUROPEAN GREEN CITIES APS (Denmark)
- ASM - CENTRUM BADAN I ANALIZ RYNKUSPOLKA Z OGRANICZONA ODPOWIEDZIALNOSCIA (Poland)
- SVEUCILISTE U ZAGREBU, FAKULTET STROJARSTVA I BRODOGRADNJE (Croatia)
- NEDERLANDSE ORGANISATIE VOOR TOEGEPAST NATUURWETENSCHAPPELIJK ONDERZOEK TNO (Netherlands)
- COOPERATIEVE VERENIGING GRUNNEGER POWER UA (Netherlands)
- EMAC EMPRESA MUNICIPAL DE AMBIENDEDE CASCAIS EM SA (Portugal)



Project Description

Context: The European Commission has introduced the concepts of Renewable Energy Communities (RECs) and Citizen Energy Communities (CECs). By doing so, it is promoting a more active role of EU citizens in the energy markets. However, there are several barriers that need to be lifted. In this context, the EU-funded COMMUNITAS project will promote energy citizenship, empowering citizens to take control of the path towards sustainability by becoming active elements of the energy markets.

Scope: COMMUNITAS will pave the way for the empowerment and engagement of different types of consumers and prosumers, placing them at the heart of energy markets. It will do so by boosting the creation and exploiting the potentialities of ECs as hubs for innovative energy services, integrated with non-energy benefits, co-created together with citizens and other stakeholders. The project will put consumers organised in ECs at the forefront of the digitalisation, decentralisation, decarbonisation, and democratisation of the energy sector.

To achieve this the project will deliver a knowledge base providing users with technical, administrative, and legal information on energy communities and set tools that enable citizens to participate in different energy markets.

Technical description and implementation: COMMUNITAS will develop a core platform that will include different tools for the members and managers of energy communities that will enable a more active participation in energy activities and the growth of energy communities across Europe.

- A Knowledge Base will provide citizens with insights on technical, administrative, financial, and regulatory aspects on how to create and expand an energy community.
- Energy community management and planning tools will support in the improvement of day-to-day management activities and planning future implementations or expansions
- The optimization of distributed energy resources and demand response schemes will support grid planning and use of flexibility for optimization of self-consumption or in local flexibility markets
- The P2P energy market and tokens-based marketplace will constitute a local market for trading excess energy within the community
- The Guarantees of origin marketplace will enable a new revenue source for communities based on GoO trading
- Other tools such as anomaly detection, sustainable investment analysis, and non-energy sustainable practices promotion will be incorporated in COMMUNITAS core platform

The goal is that, together, these tools will provide a tool kit for communities that will support capacity building on energy and non-energy topics, as well as support to day-to-day activities, or analysis of new investments and revenue streams. The solutions developed within the

project will be implemented in 8 demonstration sites in different levels of development and different regions of Europe.

Impact: *Replicability:* - 4 demonstration sites testing operating P2P energy trading and local GoO marketplaces; - 5 demonstration sites testing Demand Response schemes; - 5 new energy communities within the project duration testing management and planning tools
Socio-economics: - reach 11.000 community members; - achieve up to 20% reduction on grid energy costs; - collect 40 insights on innovative solutions inputted by citizens; - involve 5.500 citizens in capacity building programs
Environment: - 30 MWp of new renewable energy sources installed in the demonstrators; - reduce 6.900 tons of CO2 emissions
Market Transformation: - test 12 innovative solutions; - generate 7 innovative drivers and rules beyond marginal pricing; - increase self-consumption by 15%
Policy: - engage 6 regulator entities in the project; - participate in 3 regulatory sandbox programs; - provide a set of policy recommendations



Figure 4 - Grunneger Power members in their solar farm



HORIZON-CL5-2022-D3-01-09: Grid Forming Capability (in support of the offshore strategy)

[Back to projects' list](#)



InterOPERA

Enabling Interoperability of multi-vendor HVDC grids



The global objective of InterOPERA is to de-risk the multi-vendor multi-terminal HVDC technology with grid forming capability, to pave the way to the first real-life projects in Europe and to enable the development of the European HVDC grid for offshore wind energy integration.

From 2023	Project total cost	EU contribution	Website
To 30/04/2027	69.62 M€	50.72 M€	www.interopera.eu

Technologies and services deployed		Project partners' countries
 Grid technologies	HVDC Multiterminal Protection Inertia Network Mngt monitoring & Control Tools	
 Generation technologies	Wind Turbines	

Coordinator	SuperGrid Institute (France)
-------------	------------------------------

Other partners:

- SIEMENS ENERGY GLOBAL GMBH & CO. KG (Germany)
- HITACHI ENERGY SWEDEN AB (Sweden)
- GE GRID GMBH (Germany)
- RTE RESEAU DE TRANSPORT D'ELECTRICITE (France)
- TENNET TSO GMBH (Germany)
- ASSOCIATION EUROPEENNE DE L'INDUSTRIE DESEQUIPEMENTS ET DES SERVICES DE TRANSMISSION ET DE DISTRIBUTION D'ELECTRICITE AISBL (Belgium)
- ORSTED WIND POWER A/S (Denmark)
- AMPRION GMB (Germany)
- WindEurope (Belgium)
- VESTAS WIND SYSTEMS A/S (Denmark)
- SIEMENS GAMESA RENEWABLE ENERGY AS (Denmark)
- SCIBREAK AB (Sweden)
- STATNETT SF (Norway)
- TECHNISCHE UNIVERSITEIT DELFT (Netherlands)
- ENERGINET (Denmark)
- TENNET TSO BV (Netherlands)
- EQUINOR WIND POWER AS (Norway)
- 50HERTZ TRANSMISSION GMBH (Germany)
- VATTENFALL VINDKRAFT A/S (Sweden)
- TERNA - RETE ELETTRICA NAZIONALE SPA
- TERNA RETE ITALIA SPA (Italy)
- RIJKSUNIVERSITEIT GRONINGEN (Netherlands)
- UK GRID SOLUTIONS LIMITED (UK)



Project Description

Primary Objective:

To unlock multi-vendor HVDC grids and foster the transition of the European energy sector at large scale, InterOPERA proposes a coordinated approach between a diverse, high-level group of industries at the forefront of RES development and grid management. 4 HVDC vendors, 8 TSOs, 2 wind turbine vendors and 3 wind park developers bring their industrial knowledge and practical abilities to make future HVDC systems mutually compatible and interoperable by design, and to improve the grid forming capabilities of offshore and onshore converters. Foreseen and planned HVDC projects will be analysed to define a demonstrator case study. The resulting system-level design will be usable as a guidance to coordinate offshore network planning. This new way of framing the European grid architecture and topology will ensure forward compatibility for future seamless system expansion.

Interoperability of control and protection systems will be de-risked through the execution of all necessary activities concurring to the implementation of a real-time physical demonstrator. Concrete results will be delivered through this practical work: detailed functional specifications for each subsystem, standardised models, simulation platforms and interaction study processes, multi-vendor cooperation agreements. Those frameworks will be generalised into operational and strategic tools available to all European stakeholders for the development of multi-terminal HVDC grids that will enhance offshore wind development and integration.

Market Transformation:

HVDC projects today consist of turnkey systems without modularity. The InterOPERA project will facilitate the emergence of multivendor projects. Multi-vendor modularity will considerably ease offshore grid expansion and harvesting of offshore wind energy. The building of multi-terminal and multi-purpose HVDC offshore projects, compared to radial connections, could increase the total offshore wind capacity in the North Sea by 8% in 2050/46. This is particularly significant for large offshore wind projects connected through hubs, whose capacity could increase by 13%. Though difficult to quantify, the use of large offshore hubs between different countries could reduce the electricity generation cost by 5€/MWh by 2050/53, which represents about 10% of the generation costs.

By contrast to existing projects limited to single vendor technologies, multi-vendor systems will allow competitive tender processes as well as system expansions. InterOPERA will provide recommendations on relevant splitting of HVDC projects into different lots as well as on technical specifications, assignment of responsibilities and liabilities (R10). In the future, HVDC projects would thus be broken down into elementary sub-systems, such as converter stations, switching stations, DC protection, and

DC grid control systems. This will enable and accelerate the creation of new trades for each of these building blocks, setting the scene for an updated competitive market. As an indicator, a range of value for such markets is provided for a typical 4-terminal HVDC grid: 4 AC/DC converter stations (~ 100 - 200M€ each), 4 DC switching stations (~ 50 - 200M€ each), 1 DC grid control (~ 5 - 20M€). Several (5 to 8) of such typical projects will be under development at the horizon 2030.

The standardisation and modularity of those building blocks through the specification of functional requirements will make HVDC projects more cost effective, leading to higher value creation. Indeed, by standardising HVDC modules, those systems will be less custom made for each project: this will lead to economies of scale that will directly impact either the benefit margins of the manufacturers or the prices for the project developers. It is difficult to provide an accurate estimate of this cost reduction, the ability to replicate solutions from one project to another without having to reengineer them can lead to significant savings.

InterOPERA will help to develop and widen the perspectives for the whole offshore wind value chain across Europe, and more specifically for the electrical equipment ecosystem.

Policy:

Solutions for multi-vendor project procurement, compliant with existing and future regulations, standards and laws, integrating the technical specifications and interoperability assessment tender stages, will be provided to pave the way to the first real-life projects in Europe.

External stakeholders will be involved in two-way consultation workshops to maximise the uptake of InterOPERA's key exploitable results. Recommendations to grid codes and standards will be issued.

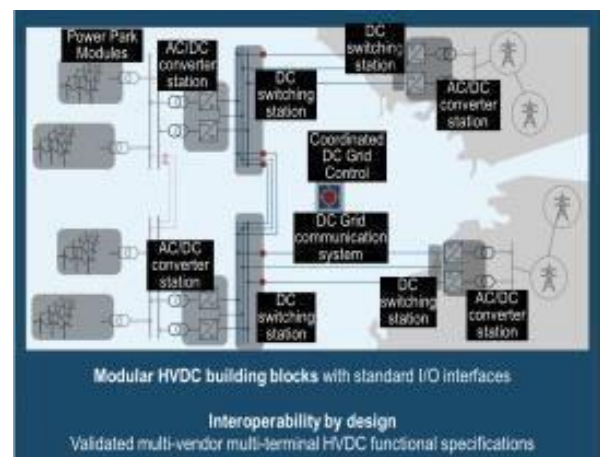



HORIZON-CL5-2022-D3-01-10: Interoperable solutions for flexibility services using distributed energy storage

[Back to projects' list](#)

FlexCHES

Flexibility services based on Connected and interoperable Hybrid Energy Storage System



With the large-scale integration of renewable energy sources (RES), a new operating paradigm has emerged. In addition, transmission and distribution feeders have become more frequently overloaded. Consequently, renewable energy has been curtailed, countering goals for high shares of RES. A valuable solution to these challenges is the introduction of flexibility through flexible resources and loads. In this context, the FlexCHES project proposes cutting-edge solutions based on the digital twin concept, virtual energy storage systems (VSS), and Distributed Ledger Technology (DLT) to revolutionize existing practices. Based on the aggregation of the Connected Hybrid Energy Storage System (CHES), FlexCHES improves grid stability while increasing the profitability of its installations by guaranteeing various ancillary services at the distribution and transmission network levels. Five pilot site demonstrations are planned in different European countries to validate and assess the proposed solutions. The aggregation and optimization of different resources will be extended to take into account not only electrical energy storage systems (ESS), but also multi-ESS.

From 01/12/2022

Project total cost

EU contribution

Website

To 30/11/2025

3.6 M€

2.3 M€

www.flexchess.eu

Technologies and services deployed

Project partners' countries



Technologies for consumers

Demand response
Smart appliances
Forecasting tools
Digital Twins



Grid technologies



Large-scale storage technologies



Distributed storage technologies

Home Batteries



Generation technologies

Heat pumps
Virtual energy storage systems



Coordinator

UNIVERSITE D'AIX MARSEILLE (France)

Other partners:

- algoWatt SpA (Country)
- RDIUP (Country)
- ARCELIK A.S. (Türkiye)
- ELEKTRO LJUBLJANA PODJETJE ZADISTRIBUCIJO ELEKTRICNE ENERGIJE D.D. (Slovenia)
- C.I.P. CITIZENS IN POWER (Cyprus)
- LA SOLAR ENERGIA SOCIEDAD COOPERATIVA (Spain)
- MY ENERGIA ONER SL (Spain)
- IREN SPA (Italy)
- IREN ENERGIA SPA (Italy)
- UNIVERSITA DEGLI STUDI DI GENOVA (Italy)
- ULUDAG ELEKTRIK DAGITIM ANONIM SIRKKETI (Türkiye)
- TOSHIBA EUROPE LIMITED (United Kingdom)
- CARDIFF UNIVERSITY (United Kingdom)



Project Description

Context. By shifting from conventional generation to variable distributed energy production, the rapid and widespread deployment of various renewable energy systems has a significant impact on the electric grid structure. This creates a new grid architecture characterized by growing variability and uncertainties. Moreover, the growth in renewables' share of total energy and their intermittency, together with the increasing electricity demand caused not only but potentially also by the significant increase of electric vehicles, are among the major origins of the increasing fluctuations in the whole load system and highly affect the supply quality of the electricity network.

Scope. Several efforts have been made by key actors to mitigate the negative effects of such large-scale integration by allowing access to wider participants in energy activities and helping both existing and new market players to support network and system operation. To reach this goal, customers with small installations (e.g., batteries, HVAC, heat pumps, smart appliances, fuel cells, etc.) can be included by adapting their power flows in synergy with the network's needs to provide additional flexibility. The key challenge lies in the developing new tools to ensure the effective aggregation and participation of these distributed installations. To this end, the FlexCHES project aims to develop a multi-level flexibility approach based on Virtual Energy Storage System (VESS) that can store surplus energy through hybrid energy storage systems (HESS) and modify their behavior and architecture to support unpredictable growth and change in demand, climate, and market.

Technical description and implementation. FlexCHES will provide an easy-to-use platform configurable through a simplified interface and make the aggregation of different ESS technologies from various brands easier and accessible to the largest number of users. In order to achieve this, the project will develop the FlexPlatform powered by a comprehensive digital twin engine enabling an effective decision-making and a successful integration of new assets into the VESS. Additionally, FlexCHES project will shorten the path to the flexibility markets through its ready-to-use CHES-Plug offering the highest level of interoperability between CHES' components and FlexPlatform. Each CHES node will share valuable information to enhance and reinforce the learning capabilities of the VESS and unlock access to meaningful information.

Impact. Replicability. During the project FlexCHES, the concepts will be replicated in more than 5 pilots and the replicability of the proven solutions will be analyzed and ensured through the T4.5. The interoperability, incentive mechanisms and the standard compliance will facilitate the replicability features.

Socio-economics. FlexCHES will monetize the services that can be provided by hybrid storage systems and flexibility actions carried out by end-users. Increase

income by 50% and reduce investment cost by around 50%, compared to conventional energy storage. The project will enhance the role of citizens and put them in the center of the energy systems and promote the building of sustainable energy communities. The FlexCHES tools will increase the awareness of the energy transition and consumers will become more engaged and active.

Environment: FlexCHES intends to increase the share of renewable energy systems by providing flexibility services. Also, it will reduce CO2 emissions by storing green energy and release it when it is needed. In this direction, FlexCHES will contribute to the energy savings thanks to storage scheduling via Digital twin optimization, Time of Use, eco-collective action (BSF), consumer engagement behavior through dynamic incentive rewarding through the increasing of mix storage systems penetration and controllable loads.

Market Transformation: FlexCHES will contribute to a coherent digital single market, ensuring all stakeholders get fair share of benefits for their participation in the energy activities through a rewarding-based business model. Therefore, FlexCHES will unlock access of SMEs and startups to critical information, digital tools and data-driven models supporting them to fill gaps in their digital transformation and co-creation of new opportunities, products (e.g. smart appliances, controllable loads) and services (e.g. primary flexibility) for the energy transition. FlexCHES will also provide open access meaningful information to end-users and energy companies and follow standards related to interoperability (SGAM structure, OEO, CDF, and OPSD)..

Policy: FlexCHES considers and adopts the Integrated SET- Plan Action 7 which promotes the implementation of storage technologies. Moreover, the shared Knowledge Base (SKB) platform will share best practices and increase users' knowledge and experience for energy storage management and flexibility trading, to develop a vision for applying the FlexCHES technologies, and to provide policy recommendations for decision makers. Moreover, FlexCHES' exploitation, joint actions & dissemination efforts collectively aim to support the development of an interoperable common protocol.

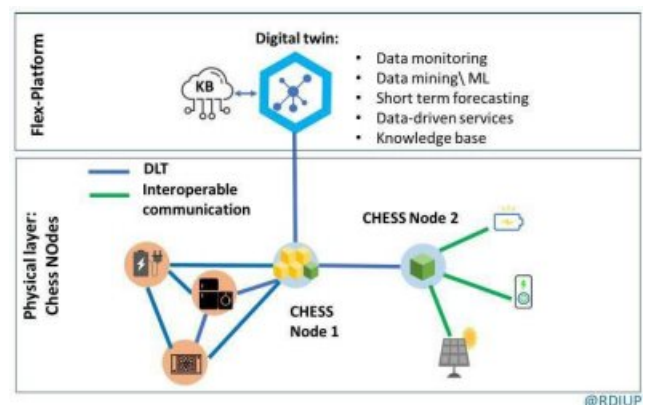

@RDIUP



HORIZON-CL5-2022-D3-01-10: Interoperable solutions for flexibility services using distributed energy storage

[Back to projects' list](#)

INTERSTORE

Interoperable open-source Tools to Enable hybridisation, utilisation, and monetisation of storage flexibility



Storage is a very diverse universe of solutions and technologies with very different characteristics. InterSTORE plans to address this complexity by developing an innovative middleware that, while virtualising the storage technology, will simplify its use from the point of view of integration platform thanks to a technology agnostic approach. The middleware will facilitate the integration of storage creating an independence from hardware solutions which are critical from customer perspectives to avoid vendor lock-in solutions and assure the compliance to the new IEEE 2030.5 standard. It will also facilitate its use from a monetisation perspective making sure that more investments in storage are enabled. The new InterSTORE solution will be tested and validated in a 4 real life with the goal to develop testing software to be adopted in the future for interoperability certification.

From 01/01/2023

Project total cost

EU contribution

Website

To 31/12/2025

4.355.197,50 €

3.498.630,75 €

<https://interstore-project.eu>

Technologies and services deployed

Project partners' countries



Technologies for consumers

Home Energy Management System



Grid technologies

Residential Power Management System



Large-scale storage technologies

Flexibility Management Platform



Distributed storage technologies

Hybrid Distributed EMS



Generation technologies



Coordinator

Other partners:

- RHEINISCH-WESTFAELISCHE TECHNISCHE HOCHSCHULE AACHEN (Germany)
- CYBERGRID GMBH & CO (Austria)
- ENEL X SRL (Italy)
- FORSCHUNGSZENTRUM JULICH (Germany)
- INESC TEC - Instituto de Engenharia de Sistemas e Computadores, Tecnologia e Ciência (Portugal)
- HYBRID ENERGY STORAGE SOLUTIONS (Spain)
- EATON INDUSTRIES (Germany)
- SUNESIS, INOVATIVNE TEHNOLOGIJE IN STORITVE (Slovenia)
- VDE VDE VERBAND DER ELEKTROTECHNIK ELEKTRONIK INFORMATIONSTECHNIK (Germany)
- CAPWATT (Portugal)
- ENGINEERING - INGEGNERIA INFORMATICA SPA (Italy)
- EASE EUROPEAN ASSOCIATION FOR STORAGE OF ENERGY (Belgium)



Project Description

The overall vision of InterSTORE is to deploy and demonstrate a set of interoperable Open- Source tools to integrate Distributed Energy Storage (DES) and Distributed Energy Resources (DER), to enable the hybridization, utilisation and monetisation of storage flexibility, within a real-life environment. The project outcome will allow various DES, DER and several new generation Energy Management Systems (EMS) to be integrated by different stakeholders, while demonstrating the value added of asset's connection to common data space, reducing uncertainty and hence increasing acceptance by technology takers and final users.

In achieving this vision InterSTORE will provide 4 software open-source tools for assuring interoperability, flexibility and data standardization. Consider each relevant aspect of flexible use of HESS in different main application areas (EV, Industrial, Residential, Commercial). Demonstrate 7 high impact use cases in 4 real life living labs. Use beyond the state-of-the-art methods to enable hybridization, utilisation and monetisation of storage flexibility, while also ensuring data space standardization.

Context:

- N1. There is a need to assure Interoperability within distributed energy resources across different applications
- N2. Is needed to demonstrate the economic and sustainability benefit of HESS and data sharing to promote user acceptance and data privacy.
- N3. To build and trade new flexibility service and storage monetization is required a standardize data architecture
- N4. To assure new decentralize flexibility products uptake is essential to reduce the complexity and time consuming integration between flexibility asset (DER) and aggregation platform
- N5 Hybridization of HESS

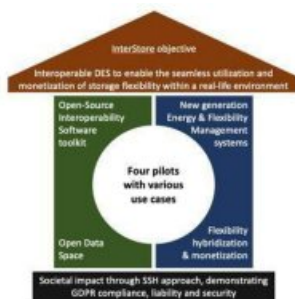

Scope:

- R1 Development of 4 Open-source interoperability toolkit and implementation of 4 EMS and flexibility products in 4 real pilots:
Interoperable client/server for Distributed Energy Storage
Legacy System protocol converter
Testing procedures and software tools
EMS for HESS across different applications
- R2 Increase number of stakeholders interested in data space, promoting data valorization through public API of DES/DER SoF

R3 Development and testing of new business model for energy community, allowed by Flexibility Aggregation Platform

R4 Creation of synergies among different interoperability standards (IEEE 2030,5, and similar,...) and facilitation of its implementation

Technical description and implementation.

The overall vision of InterSTORE is to deploy and demonstrate a set of interoperable Open- Source tools to integrate Distributed Energy Storage (DES) and Distributed Energy Resources (DER), to enable the hybridization, utilisation and monetisation of storage flexibility, within a real-life environment. The project outcome will allow various DES, DER and several new generation Energy Management Systems (EMS) to be integrated by different stakeholders, while demonstrating the value added of asset's connection to common data space, reducing uncertainty and hence increasing acceptance by technology takers and final users.

Impact.

Replicability: Design and implementation is aligned with EC's Energy Package "Clean Energy for All Europeans

Market Transformation:

Significant cost saving economic impact in the all cases scenarios as presented in the project.

Valorization multiple 9 UCs

Policy: Contribute to standardization through the creation of synergies among different domains (IEEE 2030,5, and similar) and provision of recommendation to standardizations bodies

Engagement of policy makers through recommendation on how to reduce and remedy gaps in the la

InterSTORE objective are aligned with the 6 research areas identified by ETIP SNET roadmap 2020-2030



HORIZON-CL5-2022-D3-01-10: Interoperable solutions for flexibility services using distributed energy storage

[Back to projects' list](#)

PARMENIDES

Plug&play eneRgy ManagEmeNt for hybrid Energy Storage



PARMENIDES aims to develop a new ontology with a focus on the electricity and heating domain for buildings, customers, and energy communities. It will support different use cases, focusing on the utilization of Hybrid Energy Storage Systems (HESS). A new generation of innovative Energy Management Systems (EMS) will be developed, capable of using ontology as a knowledge base. PARMENIDES will define an information and communication architecture, enabling an interoperable, reliable, and secure exchange of data and instructions. The developed EMS will be demonstrated in very diverse pilots in Austria and Sweden.

From 01/01/2023

Project total cost

EU contribution

Website

To 31/12/2025

3.626.814,50 €

2.990.477,00 €

<http://parmenides-project.eu/>

Technologies and services deployed

Project partners' countries



Technologies for consumers

Demand response
Smart appliances
Smart metering



Grid technologies

Network management, monitoring and control tools



Large-scale storage technologies

Power to gas



Distributed storage technologies

Batteries
Electric vehicles
Thermal Energy Storage



Generation technologies

PV



Coordinator

AIT Austrian Institute of Technology GmbH (Austria)

Other partners:

- KUNGLIGA TEKNISKA HOEGSKOLAN (Sweden)
- TRIALOG (France)
- ENERGIENETZE STEIERMARK GMBH (Austria)
- MAPS S.P.A. (Italy)
- R2M SOLUTION SRL (Italy)
- EUROPEAN DISTRIBUTED ENERGY RESOURCES LABORATORIES (DERLAB) EV (Germany)
- Experientia Global SA (Switzerland)



Project Description

Context The ongoing transition of the energy system is accompanied by digitalization activities, enabling new applications. This results in a fragmentation of existing platforms, protocols, and standards. Therefore, interoperability among various platforms as well as cross-domain interoperability must be ensured. The usage of ontologies provides an opportunity to address cross-platform and cross-domain interoperability.

Scope. PARMENIDES aims to develop a new ontology by extending existing ontologies to provide a knowledge base, with a focus on the electricity and heating domain for buildings, customers, and energy communities. It will support different use cases, focusing on the utilization of Hybrid Energy Storage Systems (HESS). Besides the representation of storage technologies, information about energy community customers, their behaviours, and components including their relation will be part of the ontology, providing a standardized vocabulary of the domain of energy communities. This further includes technical, economic, regulatory, behavioural, and social constraints to be considered in operation. To support several use cases, a new generation of innovative Energy Management Systems (EMS) will be developed. This system will be capable of using ontology as a knowledge base. PARMENIDES will define an information and communication architecture, enabling an interoperable, reliable, and secure exchange of data and instructions. The developed EMS will be demonstrated in very diverse pilots in Austria and Sweden.

Technical description and implementation.

PARMENIDES is based on the following main goals and activities:

- Identification of relevant end-users and stakeholders and their needs, values and goals associated with energy communities, flexibility services, and energy management.
- Identification and definition of relevant use cases and derivation of the technical, economic, regulatory, and social requirements.
- Definition of an interoperable, reliable, and secure ICT architecture, standards for HESS, and a generic ontology (PARMENIDES Energy Community Ontology, "PECO") for energy communities and the flexibility utilization provided by HESS.
- Development of an ontology-based, interoperable, plug & play energy management system ("PARMENIDES EMS4HESS") capable of handling the virtual representation of different storage technologies, time resolutions, and aggregation levels.
- Demonstration of the developed solutions in very diverse pilots in Austria and Sweden and in a virtual environment for scalability and replicability analysis. The validation will cover technical, economic, behavioural, and social aspects and will derive recommendations on improvements of the solutions as well as for standardization activities of the developed ontology.

Impact. *Replicability:* PARMENIDES enables a new generation of energy management systems based on ontologies to support the flexibility utilization of HESS in a high degree of interoperability. It will be demonstrated in very diverse pilots, nevertheless, the overall concept also supports replication and up-scaling of the solution.

Socio-economics: PARMENIDES addresses energy community customers and various stakeholders and aims to improve the understanding of flexibility dynamics and to increase the acceptance of dynamic and flexible energy demand systems. PARMENIDES will validate the user acceptance, and demonstrate concepts ensuring privacy, liability, security, and trust in connected data spaces.

Environment: PARMENIDES aims to increase energy flexibility at different levels and thus, to reduce the peak power in the pilots. The EMS4HESS can handle a variety of customers, buildings, and energy communities equipped with a large variety of storage technologies, control techniques, and several participants involved. Finally, the integration of additional Renewable Energy Sources (RES) will be supported.

Market Transformation: PARMENIDES will foster the European market for new energy services and business models as well as tested standardised and open interfaces of energy devices through a higher degree of interoperability, increased data availability and easier data exchange among energy companies as well as companies using energy system data.

Policy: PARMENIDES will push forward standardisation and regulation for energy storage management either at the level of single components or of the whole distributed and shared energy system. PARMENIDES will identify potential contributions of the project results to relevant standardization bodies. Moreover, PARMENIDES's solutions are likely to contribute to the recognition of the requirements and the enhancement of the features of the ongoing standards.

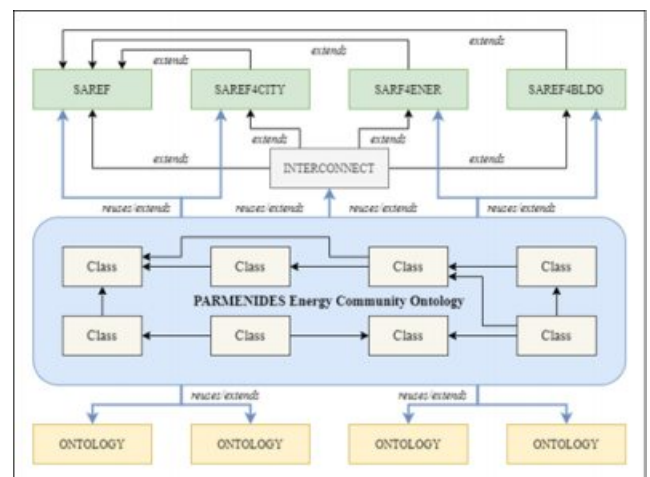



HORIZON-CL5-2022-D3-01-11: Demonstration of innovative forms of storage and their successful operation and integration into innovative energy systems and grid architectures

[Back to projects' list](#)







2LIPP

2nd Life for Power Plants



The 2LIPP project aims to demonstrate a scalable hybrid storage system based on several state-of-the-art storage technologies and an innovative energy management system (EMS). The demonstration will serve as a proof-of-concept for a disruptive approach to transitioning traditional power and combined heat and power (CHP) into a renewable energy grid.

From 2023	Project total cost	EU contribution	Website
To 31/12/2025	13.5 M€	7.9 M€	www.2lipp.com

Technologies and services deployed		Project partners' countries
 Technologies for consumers	Demand response	
 Grid technologies	Network management, monitoring and control tools	
 Large-scale storage technologies		
 Distributed storage technologies	Batteries, Flywheel, Molten Salt Storage	
 Generation technologies	Wind Turbine	

Coordinator	Energy Cluster Denmark (Denmark)
-------------	----------------------------------

Other partners:

- Energy Cluster Denmark (Denmark)
- Bornholms El Produktion As (Denmark)
- Fraunhofer Gesellschaft Zur Forderung Der Angewandten Forschung Ev (Germany)
- Teknologisk Institut (Denmark)
- Danmarks Tekniske Universitet (Denmark)
- PLS-Energy Systems I Hestra Ab (Sweden)
- Quinteq Energy B.V.(Nederland)
- HYME Storage Aps (Denmark)
- Pini Sverige Ab (Sweden)
- Politechnika Gdanska (Poland)
- Miejskie Przedsiębiorstwo Ciepłowniczo-Komunalne Koksik - Spolka Z Ograniczona Odpowiedzialnoscia (Poland)
- Netzgesellschaft Eisenberg Mbh (Germany)
- Euroheat & Power (Belgium)
- Ernst-Abbe-Hochschule Jena (Germany)



Project Description

Context: The 2LIPP project will develop a HYBRID STORAGE concept to efficiently address the rapidly increasing problems of rising energy cost and grid instability from high levels of renewable energy, that are slowing down the green energy transition in Europe. To develop this concept, a medium scale demonstrator will be built on the Danish Island of Bornholm. It is a meshed island grid with a mainland connection, island mode requirements and a high penetration of renewable energy, making the site an optimal demonstration site to address our objectives. To maximize the impact, several larger sites around Europe will be used for case studies, including power plants run by partners.

Scope: 2LIPPs strategic objectives are:

- To demonstrate an efficient and cost-effective transition for existing utility owners and their power plants based on the experiences at the demo site at Bornholm.
- To develop business models and systems designs for the hybrid storage system in the project, both as standalone systems and as the combined hybrid 2LIPP system.
- To minimize losses and maximize synergy between energy storage and heat and electricity production at power plants.
- To create roadmaps in the form of case studies for the sustainable transition of power plants to a green future reusing obsolete or underused power plant infrastructure and creating second life renewable energy utilities based on value proven European technologies.

Technical description and implementation: The three storage technologies are chosen to represent very different power to energy ratios. The flywheel is providing unprecedented power but must be cycled several times an hour to reach the best possible cost of storage as its lifetime is largely independent of the number of cycles due to the unique fully levitating flywheel technology. The molten salt storage, on the other hand, provides enormous energy storage that can be increased by varying the size of the storage tank, but it is limited by the current turbine technology and cannot react to fast changes in demand. The BESS system is used to bridge the two systems and to provide energy shifts on the hours scale. The BESS system is a flexible and modular system based on different battery types. Using everything from new Li-ion batteries, second life PHEV / BEV batteries. Finally, the unique EMS will enable the system to be scaled to provide high power or high energy and help the technologies to run at their highest efficiencies through optimal dispatch strategies.

Impact: Replicability: The 2LIPP project aims at facilitating the implementation of the innovative 2LIPP retrofit concept in utilities in Poland and Germany through the creation of an investment decision tool. The sub-objective is also to support the specific participating power plants in their decision-making about whether and how to retrofit their facilities. The exploitation strategy will ensure that utility owners become aware of the benefits and can relate them to their own utilities through the feasibility use cases of the project.

Socio-economics: Being overall responsible for the grid stability in each country or region in Europe, the TSOs are major stakeholders who will benefit from 2LIPP. They are important in managing the grid, but also important because the consumers are the ones who – in the end – cover the bills of the TSOs. So, savings for the TSOs equal savings to consumers.

Environment: We believe that 2LIPP – going towards 2050 will have the potential to replace a large fraction of the current fossil-fired capacity. Most of the coal capacity is scheduled to be phased out by 2030 or 2035 due to national reduction targets, which puts a huge pressure on the utility companies owning these plants to find alternatives. After 2030/2035, the phase-out of gas and biomass plants will also take speed to keep on targets to CO₂-neutrality. We estimate that a total of 20 % of the electrical generating capacity could be retrofitted by 2050, maybe already by 2045.

Market Transformation: The key result which will be of use to power and CHP plants in Europe, are the feasibility case studies, the investment decision tool developed by the project and, of course, the availability of the EMS system to deploy the 2LIPP concept. The 2LIPP concept opens new market for storage technologies because utilities become part of their customer base, not only renewable energy developers/providers. This will accelerate the deployment of energy storage. The sites and facilities of utilities power plants become part of the storage value chain, and by implementing storage here the cost of implementing storage will be further reduced by 20-40 %. Importantly, the utilities can choose to do a gradual transition as renewables become more integrated in the grid, and more storage is needed. This can be done through partial retrofit approaches on the way to a full retrofit.

Policy: Some Policy recommendations on Energy storage will be developed.



HORIZON-CL5-2022-D3-01-11: Demonstration of innovative forms of storage and their successful operation and integration into innovative energy systems and grid architectures

[Back to projects' list](#)







AGISTIN

Advanced Grid Interface for innovative Storage INtegration



AGISTIN will enable industrial grid users to rapidly deploy renewables through advanced integration of innovative energy storage technologies at the interface with the grid.

From Jan 2023 To Dec 2026	Project total cost	EU contribution	Website
	8.8 M€	7.9 M€	https://www.agistin.eu/

Technologies and services deployed		Project partners' countries
 Technologies for consumers	Grid forming inverters	
 Grid technologies	Microgrid Grid services	
 Large-scale storage technologies	Irrigation canals as storage	
 Distributed storage technologies	Aqueous batteries EV Fast charging	
 Generation technologies	Solar PV Renewable hydrogen	

Coordinator	EPRI EUROPE DAC (Ireland)
-------------	---------------------------

Other partners:

- UNIVERSITAET KASSEL - UNI KASSEL (Germany)
- RTE RESEAU DE TRANSPORT D'ELECTRICITE (France)
- FRAUNHOFER GESELLSCHAFT ZUR FORDERUNG DER ANGEWANDTEN FORSCHUNG EV - FHG (Germany)
- FUNDACION CARTIF - CARTIF (Spain)
- CENTRO DE INVESTIGACIONES ENERGETICAS, MEDIOAMBIENTALES Y TECNOLOGICAS-CIEMAT - CIEMAT (Spain)
- SHELL GLOBAL SOLUTIONS INTERNATIONAL BV (Netherlands)
- UNIVERSITAT POLITECNICA DE CATALUNYA - UPC (Spain)
- GEYSER BATTERIES OY (Finland)
- INFRASTRUCTURES DE LA GENERALITAT DE CATALUNYA SA - I.CAT (Spain)
- EUROPEAN ASSOCIATION FOR STORAGE OF ENERGY (Belgium)
- RINA CONSULTING SPA - RINA-C (Italy)

Associated partners:

- EIDGENÖSSISCHE TECHNISCHE HOCHSCHULE ZÜRICH - ETH (Switzerland)



Project Description

Context. The rapid and widescale deployment of renewables and electrification of society presents a challenge for grid operators to develop and operate the grid reliably. In European grids challenges for grid development, grid access, network congestion, operations with low inertia grids, human capital and supply chain threaten to impede the realisation of decarbonisation goals, despite the best effort of grid operators. Energy storage is the key resource that is needed to orchestrate and integrate industrial processes and large-scale renewables. Advanced storage integration methods are needed to resolve issues for grid users and operators.

Scope. The AGISTIN project addresses urgent needs for rapidly deploying renewables for industrial grid users, grid operators, renewable energy developers and energy storage providers. The scope of the project is to:

- Demonstrate the performance and value of innovative energy storage technologies providing flexibility and grid services,
- Design advanced grid interfaces (AGI) to integrate energy storage with industrial grid users and on-site generation,
- Demonstrate the technical feasibility of the innovative coupling of multiple forms of energy storage,
- Enable innovative storage, coupled through the proposed AGI technologies to provide the new grid services needed in the energy transition,
- Reduce material use and embedded emissions,
- Propose innovative business models to easily enable energy storage integration with significant grid users.

Technical description and implementation.

In AGISTIN project, the needs and potential opportunities of the various stakeholders will be identified, and technical, economic, and environmental performance criteria will be defined, which will be considered in the design of AGI. The developed solution design will then be tested in simulations and tested in three separate laboratory tests. The refined design will then be implemented in two field demonstrations.

- The German laboratory test will test the design's controls and functionality on a fast-charging application for electric vehicles,
- The Spanish laboratory test will test the concept on a pumping system before implementation in a real irrigation system,
- The German laboratory test will test the developed solution for an electrolyzer application using a dynamic grid emulator.

The refined design will then be implemented in two field demonstrations.

- The Spanish demonstration pilot will demonstrate the potential of using irrigation systems as an energy storage medium
- The Dutch demonstration pilot will demonstrate the use of energy storage and advanced control to maximize the use of renewables on a renewable hydrogen generation facility.

Impact. Replicability: The AGISTIN project will support the deployment of 300 GW of renewables and storage, which are set as target for industrial grid users by 2050 by addressing the following issues:

- The cost and availability of energy storage
- The increasing cost, availability, and complexity of the grid
- The value for industrial grid users

Socio-economics: The AGISTIN project by accelerating the adoption of widescale renewable energy sources by industrial grid users will avoid delayed electrification and decarbonisation of society, resulting in a reduction of Mt of CO₂ avoided per annum, which will benefit society at large.

Environment: The AGISTIN project will contribute to the reduction of material use and embedded emissions through innovative approaches to the integration of energy storage into industrial grids. The AGISTIN project will demonstrate that its concept will significantly reduce the need for extractive metals such as lithium, nickel, cobalt, improves recovery end-of-life recovery and influences land use requirements for both storage technologies examined and the AGI.

Market Transformation: Demonstrating beyond State-of-the-Art storage technologies and grid interfaces, enables AGISTIN to realise a drastic transformation of the energy sector, surpassing the limitations of current storage integration approaches that impede access to the flexibility needed to reach net-zero from deep sector coupling.

Policy: The results and findings of the project will provide input for network code drafting groups, policy makers and standards developers.

Advanced
Grid
Interface for
innovative
Storage
INtegration

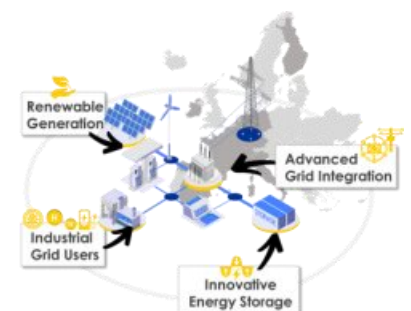



HORIZON CALL: CL5-2022-D3-01-11: Demonstration of innovative forms of storage and their successful operation and integration into innovative energy systems and grid architectures

[Back to projects' list](#)







i-STENTORE

innovative Energy Storage TEchnologies TOwards increased Renewables integration and Efficient Operation



The i-STENTORE project aims to introduce innovative energy storage technologies, propose hybrid energy storage systems, and create an umbrella framework for assessing efficient energy storage solutions for various applications, with a focus on decentralization of the power sector, co-optimization of integrated assets, and strengthening the European storage value chain.

From 2023	Project total cost	EU contribution	Website
To 31/12/2025	10.0 M€	8.1 M€	http://istentore.eu/

Technologies and services deployed		Project partners' countries
 Technologies for consumers	Demand response Smart metering	
 Grid technologies	Network Management, monitoring and control tools Micro-grid management	
 Large-scale storage technologies	Power to gas Hydro-pump storage Thermal Energy Storage	
 Distributed storage technologies	Li-ion and VRFB Batteries Electrical Vehicles	
 Generation technologies	Wind Turbines PV Biogas	
 Market	Electricity markets Ancillary services & Balancing Markets	

Coordinator

EUROPEAN DYNAMICS LUXEMBOURG SA (Luxembourg)

Other partners:

- Engineering - Ingegneria Informatica S.p.A. (ENG) (Italy)
- Luxembourg Institute Of Science and Technology (LIST) (Luxembourg)
- Fraunhofer Gesellschaft Zur Förderung Der Angewandten Forschung EV (FHG) (Germany)
- National Technical University of Athens (NTUA) (Greece)
- Bioeconopmy & Environmental Cluster of Western Macedonia (CLUBE) (Greece)
- F6S Network Ireland Limited (F6S) (Ireland)
- Empresa de Electricidade da Madeira S.A. (EEM) (Portugal)
- Inesc Tec - Instituto De Engenharia Sistemas e Computadores, Tecnologia e Ciência (INESC) (Portugal)
- Vasco Da Gama CoLAB - Energy Storage - Associacao (VGLAB)
- Reefilla S.r.l (REEF) (Italy)
- Nio GmbH (NIO) (Germany)
- Centre for Research & Technology Hellas (CERTH) (Greece)
- Orizon A.T.C. (HOR) (Greece)
- Comensus, Komunikacije In Senzorika, D.O.O. (COMS) (Slovenia)
- Steklarna Hrastnik Druzba Za Proizv Proizvodnjo Steklenih Izdelkov D.O.O. (HRAS) (Slovenia)
- Cuerva Energia S.L.U. (MECSA) (Spain)
- Aggregering S.L. (AGG) (Spain)
- Energy Storage Solutions S.L. (E22) (Spain)
- Cuadros Electricos Nazarenos S.L. (CEN) (Spain)
- Universidad Carlos III de Madrid (UC3M) (Spain)
- Universidad De Malaga (UMA) (Spain)(Portugal)
- Università degli Studi di Napoli Federico II (UNINA) (Italy)
- Samso S.p.A. (SAMSO) (Italy)
- Green Power Storage Solutions (GPSS) S.A. (Luxembourg)
- Studio Elektronike Rijeka D.O.O. (STER) (Croatia)
- Regulatory Assistance Project (RAP) (Belgium)



Project Description

Context. In the light of the “European Green Deal” which envisions a climate-neutral EU by 2050, a plethora of policies and commitments have sparked fundamental changes in the energy landscape. The increasing use of renewable energy sources creates a need for flexibility, which can be achieved through energy storage, demand response schemes, and dispatchable power generation technologies, with investment in large-scale storage deployment being key to achieving the set climate goals. The combination of different storage technologies and the deployment of Hybrid Energy Storage Systems (HESs) enables the participation of storage in ancillary services, balancing and intra-day markets. HESs pose as potential solutions to flexibility shortage of RES-based power systems while strengthening the operational management and interfacing to grids, and deferring the versatile drawbacks of individual storage technologies.

Scope. The i-STENTORE project aims to formulate an umbrella framework for integrating and optimizing diverse storage solutions in various sectors, including mobility, agriculture, industry, and households. This approach will develop and validate the enhanced connectivity of multiple systems at different levels of the energy value chain, by embracing the introduction of novel business models, to incorporate both front-of-the-meter and behind-the-meter solutions, targeting the essential empowerment of new actors and the strategic shift of the role of storage.

The framework will showcase stand-alone and hybrid storage systems (SASS and HESS respectively) that can serve as more than simple energy buffers and constitute active grid components, contributing to grid resilience, stability, and efficient operation. To ensure seamless and robust integration in a technology-agnostic and interoperable manner, i-STENTORE will design a Reference Architecture towards an open and flexible storage-enabling European energy system, promoting storage systems as a facilitator of the energy transition and identifying new revenue streams for storage operators.

Technical description and implementation. The i-STENTORE project aims to integrate various energy storage (ES) technologies that go beyond the state-of-the-art both from a technological but also from an operational point of view into a storage-centric enabling platform for advancing multi-purpose solutions on the European power system, aiming for increased storage flexibility. This involves the creation of a versatile ICT and data driven framework that showcases innovation in integrated ES systems, stand-alone storage systems, and novel operational and management concepts. The project includes integrating a set of 5 diverse pilots and a Living Lab hosted under different climatic conditions and renewable potential. As to the regulatory front, the project will investigate barriers for participation of storage systems to the markets and the impact on the grid from current ES systems. As a business enabling platform, i-STENTORE will offer more opportunities for storage participation in markets and services provisioning,

targeting different sectors, and leveraging stand-alone and hybrid energy systems in order to identify new revenue streams, design case-positive investments and promote storage as a service, by prioritizing sustainability, increasing renewable energy penetration and minimizing environmental footprint.

Impact. Replicability/Scalability. A set of diverse pilots will be integrated in the i-STENTORE framework facilitated by the aforementioned interoperable platform. The pilots will incorporate a wide range of storage technologies in different combinations, comprising SASSs and HESSs, hosted in different countries with different climate conditions and renewable generation potential. The results and the lessons learnt will be evaluated and the solutions will be replicated across various sectors and geographies highlighting the interoperability, scalability and effectiveness of storage in different environments. This impact assessment will show the scalability potential of i-STENTORE.

Socio-economics: The holistic i-STENTORE approach will assess techno-economic and social parameters in order to achieve a circular and sustainable storage-based economy. The project activities make a step further to create or extend value chains involving all actors, stakeholders and technologies, ranging from manufacturers, integrated solutions providers, storage owners and operators, end customers, aggregators, system operators, market operators, etc. creating a self-sustainable and profitable eco-system which will define the new roles and responsibilities as they are being identified through the pilots that highlight this multi-purpose use. Furthermore, the new functionalities offered by ESSs will give rise to new use cases and new businesses, creating new jobs based on optimal use and exploitation of indigenous energy sources that favor local development, expedite disengagement from imported Natural gas and reduce EU's dependence on third countries.

Market Transformation: Decreased complexity of installation and integration, ensuring easy data capture and processing with intelligent tools and the potential for more straightforward participation of storage in energy markets, will eventually make such solutions more attractive to even more stakeholders, including small consumers. The engagement of consumers will increase consumer acceptance which can drive deployment costs even lower and contributes to the maturity of the energy storage solutions and the operation of the grid in general.

Environment: i-STENTORE will contribute to increase the share of RES in energy production, which will decrease air pollution, GHG emissions, and the fossil fuels dependency.

Policy: i-STENTORE's business models for storage will enable the subsequent design of economically viable investment schemes, thus creating a level-playing field for incubating positive business cases, minimizing uncertainty when given a supportive and advantageous regulatory framework, which will promote the identified benefits of storage, consolidating those into clear recommendations towards policy makers and regulators.



HORIZON-CL5-2022-D3-01-11: Demonstration of innovative forms of storage and their successful operation and integration into innovative energy systems and grid architectures

[Back to projects' list](#)







SINNOGENES



Storage INN0vations for Green ENergy Systems

This project focuses on developing a complete framework of methodologies, tools and technologies (SINNO energy toolkit) that will assist the transition to clean energy by providing innovative energy storage solutions and flexible power generation while ensures the compatibility of systems and the standards of distributed energy storage for participation in flexibility markets.

From 2023	Project total cost	EU contribution	Website
To 31/12/2026	9.687.547,56 €	7.964.444,00	https://sinnogenes.eu/

Technologies and services deployed		Project partners' countries
 Technologies for consumers	Demand response	
 Grid technologies	Network management and control tools, microgrid	
 Large-scale storage technologies	Hydro-pump storage, thermal energy storage	
 Distributed storage technologies	EVs, batteries (Lithium-ion, Lead-acid Batteries, Redox flow batteries), flywheels, ultracapacitors	
 Generation technologies	Wind farms, PV plants, Power-to-Gas	

Coordinator	UNISYSTEMS LUXEMBOURG SARL	UNISY (Luxembourg)
-------------	----------------------------	--------------------

Other partners:

- UNISYSTEMS LUXEMBOURG SARL (Luxembourg)
- UNI SYSTEMS SYSTMATA PLIROFORIKIS MONOPROSOPI ANONYMI EMPORIKI ETAIRIA (Greece)
- UBITECH ENERGY (Belgium)
- ARTELYS (France)
- RINA CONSULTING SPA (Italy)
- FUNDACION CIRCE CENTRO DE INVESTIGACION DE RECURSOS Y CONSUMOS ENERGETICOS (Spain)
- FONDAZIONE BRUNO KESSLER (Italy)
- METAMIND INNOVATIONS IKE (Greece)
- CINTECH SOLUTIONS LTD (Cyprus)
- UNIVERSITA DEGLI STUDI DI GENOVA (Italy)
- CAPWATT, S.A. (Portugal)
- INESC TEC - INSTITUTO DE ENGENHARIADE SISTEMAS E COMPUTADORES, TECNOLOGIA E CIENCIA (Portugal)
- UNIVERSIDADE DO PORTO (Portugal)
- FUNDACION CARTIF (Spain)
- CENTRO DE INVESTIGACIONES ENERGETICAS, MEDIOAMBIENTALES Y TECNOLOGICAS-CIEMAT (Spain)
- INSTRUMENTACION Y COMPONENTES SA (Spain)
- FUNDACION PARA EL DESARROLLO DE LAS NUEVAS TECNOLOGIAS DEL HIDROGENO EN ARAGON (Spain)
- SCHNEIDER ELECTRIC ESPANA SA (Spain)
- DEUTSCHES ZENTRUM FUR LUFT - UND RAUMFAHRT EV (Germany)
- SANDDORN GMBH HERZBERG (Germany)
- DIACHEIRISTIS ELLINIKOU DIKTYOU DIANOMIS ELEKTRIKIS ENERGEIAS AE (Greece)
- INDEPENDENT POWER TRANSMISSION OPERATOR SA (Greece)
- ETHNIKO KAI KAPODISTRIAKO PANEPISTIMIO ATHINON (Greece)
- ETHNIKO KENTRO EREVNAS KAI TECHNOLOGIKIS ANAPTYXIS (Greece)
- Energy Web Stiftung (Energy Web Foundation) (Switzerland)
- TRANSPORTS PUBLICS GENEVOIS (Switzerland)
- UNIVERSITE DE GENEVE (Switzerland)
- Hitachi ABB Power Grids Ltd. (Switzerland)



Project Description

Context: In SINNOGENES participating 27 partners from Portugal, Spain, France, Belgium, Luxembourg, Germany, Greece, Italy, Cyprus and Switzerland. It includes 6 demonstration sites in 5 different European countries. The proposed energy toolkit (SINNO) will be tested in different environments and demand sectors.

Scope. SINNOGENES will demonstrate the operation of energy storage technologies in different concepts and architectures including: operation of hydro-pumped storage in an insular ecosystem, hybrid energy storage technologies in industrial microgrids coupled with local RES, and decarbonization of industrial processes with the help of PV plants.

Technical description and implementation. The project focuses on harvesting the flexibility potential of assets existing in different levels of the energy system, in order to provide flexibility services to operators through the utilization of innovative storage technologies. SINNOGENES will exploit the benefits that each innovative storage technology offers, to provide a portfolio of flexibility services encapsulating the following aspects:

- Types of flexibility service: Peak-shaving, Fast Frequency, Regulation, black start, energy arbitrage, congestion relief, dynamic regulation
- Time horizon: Short-term (Intra-day, Real-time), Medium-term (Day-ahead to Week-ahead), Long-term (Planning)
- Procured by: Microgrid Operator, TSO and DSO
- Cross-energy carriers: electricity coupling with Heating and Cooling, and hydrogen.

Replicability: It is essential to replicate the SINNOGENES energy toolkit in as many geographies as possible, addressing different system needs, consumer segments and needs, economic conditions or different climates. Therefore, SINNOGENES will be fully tested in six (6) frontrunner demonstration campaigns in five (5) dispersed countries. In addition, in order to maximize the impact of the project, thorough replication plans will be developed as a detailed Scalability and Replicability Analysis (SRA).

Impact:

SINNOGENES will have a serious impact in terms of economic, environmental and social benefits for European citizens, as well as for other stakeholders involved in the energy storage value chain (DSO, TSOs, LECs, etc.).

Social: SINNOGENES partners will work towards a broader cooperation of energy carriers (heat, hydrogen, electricity) contributing to EU climate targets while the flexibility services provided through the project will support the penetration of RES in the grid resulting in a direct reduction of CO₂ emissions. Furthermore, the innovative storage solutions proposed by SINNOGENES will support industrial consumers in reaching their environmental targets, it will offer easier access to self-consumption and will offer an easy and smooth integration and exchange of energy data for all types of stakeholders.

Economic: SINNOGENES work on innovative storage solutions will contribute to reducing their cost and enhancing their performance. Additionally, the technology stack will ensure interoperability among various storage solutions to facilitate the provision of flexibility services promoting SaaS business models.

Environment: SINNOGENES accelerates decarbonization of the EU electricity sector, contributing to the climate change mitigation targets set by the EU, by increasing the ability to efficiently utilize the flexibility of residential BESS, EVs, flywheels, ultracapacitors, power-to-heat and power-to-gas storage even at the edge of the distribution grid. The overall SINNOGENES technology package relieves the problems arising due to the stochastic nature of RES generation and enables the increase of the RES penetration rate in the EU energy mix. Consequently, the involved actors contribute towards the EU climate mitigation and adaptation goal, in line with the transition requirements for climate action highlighted by the Fit-for-55 package. Moreover, the SINNOGENES developed interfaces regarding the integration of hydrogen in existing electricity networks reduce natural gas consumption leading to lower CO₂ emissions.

Market Transformation: SINNOGENES will promote storage flexibility in the market, it will reduce energy costs for market participants and allow reduced RES curtailment. As a result, economic benefits will arise for the different actors in the energy value chain. Moreover, it will allow energy communities to become active agents in the energy sector by providing, for instance, flexibility to the DSO, while the blockchain-based green origins will lower the entry barriers for market participants increasing market liquidity.

Policy: The new electricity market design does not contain provisions regarding the energy storage facilities. This however has not been considered as a complication for the development of storage in the Member States, except in the case of large-scale projects such as pumped hydro or the exploitation of natural reservoirs. Moreover, energy taxation is also not addressed by the new market design, except for the requirement for network charges to not include costs supporting unrelated policy objectives. However, in 2019 the discussion on energy taxation has been reopened, with a European Commission communication and the evaluation of the Energy Taxation Directive (ETD). SINNOGENES will analyse the existing regulatory framework and disseminate the results of this analysis to the relevant policy makers providing feedback in the context of stakeholder consultation process.





HORIZON-CL5-2022-D3-01-12: Replicable solutions for a cross sector compliant energy ecosystem

[Back to projects' list](#)







GLocalFlex

A Global as well as Local Flexibility Marketplace to Demonstrate Grid Balancing Mechanisms through Cross-sectoral Interconnected and Integrated Energy Ecosystems enabling Automatic Flexibility Trading



The main objective of GLocalFlex is to mobilise demand-response solutions & services in replicated manner for prompt horizontal scaling of flexible local energy systems by means of easy access and low barrier energy flexibility marketplace to increase the participation of the consumers across all energy-sectors. The GLocalFlex promotes viable interoperable solutions and products at all levels of the grid (consumers, producers, retailers, aggregators & market) by selecting modular standards and tools during development. The GLocalFlex aims to have completely automated, machine-to-machine flexibility trading and flexibility order execution by means of open, interoperable energy flexibility market and open standard based IT-tools that allows more flexibility consumers to join the market.

From 2023	Project total cost	EU contribution	Website
To 31/12/2026	10,262,436.5 M€	8,957,646.25 M€	glocalflex.eu

Technologies and services deployed		Project partners' countries
	Technologies for consumers	
	Grid technologies	
	Large-scale storage technologies	
	Distributed technologies storage	
	Generation technologies	
		<ul style="list-style-type: none"> Demand response Smart appliances Smart metering Energy Market Network management, monitoring and control tools Micro-grid Batteries Electric vehicles Wind turbines PV

Coordinator: VTT (Finland)

Other partners:

- WithSecure Oyj (Finland)
- Technische Universität Dortmund (Germany)
- Construcciones Garcia Rama SL (Spain)
- Privanova SAS (France)
- Fundacion CTIC (Spain)
- MainFlux Labs D.O.O. (Serbia)
- Statutární město Kladno (Czech)
- Centre Scientifique Et Technique du Batiment (France)
- Skarta Energy Oy (Finland)
- Utajärven kunta (Finland)
- Ceske Vysoke Uceni Technicke V Praze (Czech)
- Fundación Tecnalia Research and Innovation (Spain)
- S.W.W. Wunsiedel GmbH (Germany)
- ef. Ruhr GmbH (Germany)
- Electricite De France (EDF)
- Fundacion Circe Centro De Investigacion De Recursos Y Consumos Energeticos (Spain)
- Office public De L'Habitat Vallee Sud Habitat (France)
- V-ZUG AG (Switzerland)
- CSEM Centre Suisse D'electronique Et De Microtechnique Sa - Recherche et Developpement (Switzerland)
- Fundacion Asturiana De La Energia (Spain)
- Nano Green s.r.o. (Czech)
- EDP Espana SA (Spain)
- System Evergreen AG (Switzerland)



Project Description

Context: The GLocalFlex concept will allow any Local Energy System (LES), Positive Energy District (PED), community, or appliance to evolve in a consistent way and offer flexibility using suitable hardware add-ons in a cost-effective and systematic manner to expose their full flexible potential. GLocalFlex concept can adopt to any LES size, availability of local resources and regulations. This project will demonstrate near real time, large scale, flexibility trading in six different field locations in Europe. It has consumer and system centric pilots that develop flexibility services and replicate them within the pilot group. The GLocalFlex methodology allows the overall energy system of systems to be 1) flexible by means of energy use to provide quality services to grid and 2) flexible by means of its own evolution (to change, upgrade or integrate several appliances, consumers and microgrids to create complex but viable cross-sectoral energy ecosystems).

Scope.

- Promoting the adoption and usage of connected interoperable energy smart home appliances.
- Accelerate deployment of demand flexibility services.
- To identify a set of open standards for Interoperability, standards & open-source solutions.
- To provide new business models enabled by connecting flexible systems from different sectors.
- Solutions developed in a pilot in one country will be replicable in other countries.
- Create and populate a commonly agreed catalogue of energy smart home appliances, services, & solutions.
- The GLocalFlex supports energy flexibility services building on interoperable solutions that can be tailored easily to need of stakeholders (fair to all relevant stakeholders).
- The solutions will use digital technologies, such as Artificial intelligence AI, Big Data, 5G, cloud/edge computing, IoT while complying with cybersecurity requirements & considering privacy issues.
- GLocalFlex will cooperate among themselves and with other relevant projects and will contribute to relevant BRIDGE17 activities.

Technical description and implementation.

GLocalFlex project is based on a few fundamental ideas: first flexibility assets are managed locally; second assets are traded in a marketplace which combines bids & offers on current market price and third all actions are automatized in order to keep the transaction cost minimal. These ideas are based on logical conclusions of future energy market scenarios. If private people and customers are offering small batches of flexibility to the market these small amounts of flexibility are not going to cost much. An average trade of few kWh's can be 1-2 euros thus the whole process: offering, making a contract, realising the offer, verifying it, and finally making the payment cannot cost more than few cents. To keep cost low flexibility

assets must be estimated by algorithms and the bids and offers must be generated autonomously. All pilot sites have this mission. There can be different levels of flexibility: device level, building level, site level and so on.

The following objectives are achieved by GLocalFlex project:

- Creating catalogue for appliances & flexibility services.
- Low-barrier energy marketplace for consumers and self-sovereign identity equipped marketplace.
- Interoperable solutions for demand response.
- Demonstrating replicability of systems and services.
- Develop equal opportunities for SMEs and consumers in real world pilots.

Impact. Replicability: Pilot sites have their own energy management methods, and they will be utilized in creating interoperable and replicable systems in Europe. Energy marketplaces will act as a bridge to bring these solutions together to find best open practices.

Socio-economics: GLocalFlex increases the consumer participation in demand-response markets, increasing integration of RES and demonstrating real value flexibility trading among energy stakeholders through GLocalFlex marketplace. Rising risk of energy poverty due to the war in Ukraine increases need for flexibility systems. Enabling customers to participate to flexibility markets allows them to generate savings and creates opportunities for power producers to integrate more RES in electricity grid.

Environment: Flexibility in cross-sector coupling will increase RES utilization and reduce emissions around (RES +20% & carbon -30% by hydro-heating-transportation).

Market Transformation: Energy flexibility marketplace is developed to allow cross-pilot energy trading that utilizes smart contracts. GLocalFlex EFMs serves all users from consumer-level up to TSO-level and has low-barrier to entry and exit along with easy onboarding using DIDs.

Policy: GLocalFlex has participation of TSOs, DSOs and energy suppliers that will give consultation and follow the possible solutions, opportunities, and challenges.

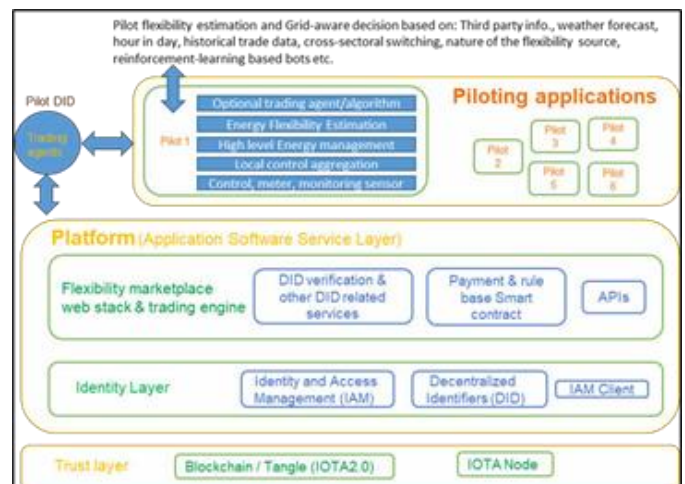



HORIZON-CL5-2022-D3-01-12: Replicable solutions for a cross sector compliant energy ecosystem

[Back to projects' list](#)

OPENTUNITY



OPENING the electricity ecosystem to multiple actors in order to have a real decarbonization opportunity

OPENTUNITY aims to create a flexibility ecosystem reducing interoperability barriers and favouring the use of standards in order to decarbonize EU grids and put the end-user in the spotlight.

From 01/01/2023	Project total cost	EU contribution	Website
To 31/12/2026	12.8 M€	8.5 M€	OPENTUNITYproject.eu

Technologies and services deployed



Technologies for consumers

HEMS and BEMS flexibility and DR optimization including initial settings algorithms.



Grid technologies

Low-cost Real-Time thermal rating.



Large-scale storage technologies

Grid planning optimization. Topology identification and state estimation.



Distributed storage technologies

Optimal selection of available flexibility.



Generation technologies

Advanced asset management.

Project partners' countries



Coordinator: ETRA I+D (Spain)

Other partners:

- ICCS (Greece)
- ENERGY WEB FOUNDATION (Germany)
- HYPERTECH (Greece)
- LJUBLJANA UNIVERSITY (Slovenia)
- HEDNO (Greece)
- ANELL (Spain)
- IMPULSA (Spain)
- JOANNEUM RESEARCH (Austria)
- UNE (Spain)
- NODES AS (Norway)
- KOLEKTOR SETUP (Slovenia)
- AMIBIT (Slovenia)
- ELEKTRO PRIMORSKA (Slovenia)
- AVANTCAR (Slovenia)
- ELEKTRO LJUBLJANA (Slovenia)
- IPTO (Greece)
- BLUE SUN (Cyprus)
- AEM (Switzerland)
- HIVE (Switzerland)
- SUPSI (Switzerland)



Project Description

Context. 2022 has been a year of extremes, with many temperature records broken and a continued rise in greenhouse gas concentrations in the atmosphere. Moreover 2022 brought unprecedented EU electricity prices rise.

Scope. OPENTUNITY’s key contribution is to create a flexibility ecosystem reducing interoperability barriers and favouring the use of standards in order to decarbonize EU grids and put the end-user in the spotlight. Grid operators, prosumers, market actors etc. will be supported by OPENTUNITY via innovative methodologies backed by advanced, interoperable software modules, in order to provide them with new features and services related to: 1) Technologies to boost flexibility in prosumer’s environment; 2) Technologies for grid operators to better manage grid operations). OPENTUNITY will also evolve, adapt and integrate an energy-specialized blockchain as a distributed, fast and reliable energy dataspace in which actors from different fields will share services and find synergies among them in order to create a reliable energy system in which different verticals (electromobility, gas, OEM etc.) will be able to seamlessly collaborate with each other.

Technical description and implementation.

OPENTUNITY will progress beyond the SOTA in:

- Blockchain technologies.
- Technologies to boost flexibility in prosumer’s environment.
- Technologies for DSOs/TSOs to better manage their grids.
- Methodologies for enhancing interoperability.

Impact. Replicability: OPENTUNITY project solutions will be demonstrated in 4 large-scale complementary demonstrators in Greece, Slovenia, Spain and Switzerland, involving a wide variety of energy sources, networks, systems and assets, and spanning heterogeneous climatic, geographic and socio-economic conditions and size, which will facilitate replicability, scale-up and eventual market launch after the end of the project. The consortium involves a variety of demonstration partners that will ensure access to critical infrastructures for the project implementation and almost all the innovations will be tested in the 4 demo sites (all of them in at least 3 demo sites) and that in most of the cases the demonstrations will be run by, at least, a Pilot partner, a local IT supporter and a horizontal partner of the consortium. Thus, OPENTUNITY ensures coherent demonstrations and future replicability.

Socio-economics: (in OPENTUNITY countries by 2032):

- Reduction in energy prices up to 5 cts/kWh in Greece, 4,98 cts/kWh in Slovenia, 6,9 cts/kWh in Spain and 6 cts/kWh in Switzerland

- Reduction of energy poverty of 30%.
- Value of Lost Load reduction of 13,2 M€ per year in OPENTUNITY.
- Yearly economic savings of 13,06M€ for operators.

Environment: (in OPENTUNITY countries by 2032):

- Yearly RES production of 1,38 TWh of green energy.
- Total GHG reductions will be 91,22 MtCO2eq.
- “Good” value in AQI.

Market Transformation:

- OPENTUNITY is expected to have a penetration of 50% in the DSOs and TSOs of OPENTUNITY countries by 2032.
- OPENTUNITY is expected to have a penetration of 25% in the HEMS/BEMS market field of OPENTUNITY countries by 2032.
- OPENTUNITY business models incentivizing flexibility and DER will support a 20% increase of RES in different types of buildings. OPENTUNITY aims to have a penetration of 40% in OPENTUNITY countries by 2032 thanks to the Business Models that will be available for ESCOs, (including start-ups and SMEs), aggregators and prosumers.

Policy: Based on interdisciplinary results obtained in OPENTUNITY, an integrated perspective of technology, users and markets will be provided to ensure the best possible impact on a broad range of target groups, accelerated technology adoption and upscaling of flexibility-markets. The needed incentive structures and supporting policy frameworks enabling a functioning cross-sector ecosystem, successfully mobilizing demand-response opportunities for new services will be elaborated.

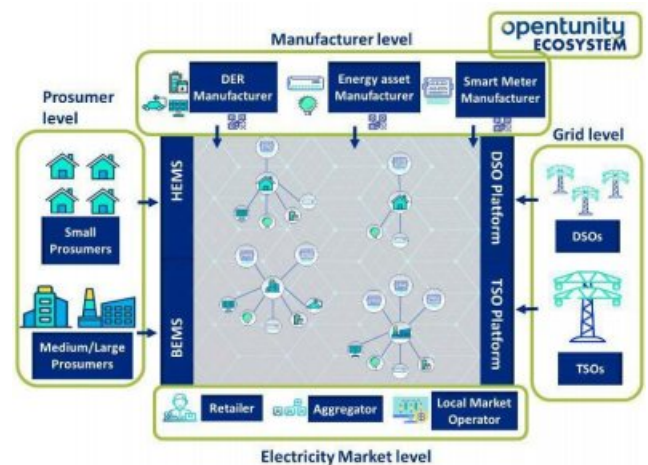



HORIZON-CL5-2022-D3-01-12: Replicable solutions for a cross sector compliant energy ecosystem

[Back to projects' list](#)





RESONANCE

Replicable and Efficient Solutions for Optimal Management of Cross-sector Energy



The RESONANCE project is creating a software framework for plug-and-play development of solutions for demand-side flexibility management of distributed and small-scale assets.

From 1/01/2023	Project total cost	EU contribution	Website
To 31/12/2025	10.2 M€	8.0 M€	https://www.resonance-project.eu

Technologies and services deployed		Project partners' countries
	Technologies for consumers	
	Demand response Smart appliances	
	Distributed storage technologies	
	EV integration	
	Generation technologies	
	Aggregator services	

Coordinator: VTT Technical Research Centre of Finland Ltd [VTT] (FI)

Other partners:

- Caverion Suomi Oyj (FI)
- Athens University of Economics and Business (EL)
- Fortiss GmbH (DE)
- Trialog SAS (FR)
- CheckWatt AB (SE)
- Enerim Oy (FI)
- Institut "Jožef Stefan" (SI)
- Smart Com d.o.o. (SI)
- European Dynamics S.A. (EL)
- Consolinno Energy GmbH (DE)
- Bovlabs (FR)
- In-Jet (DK)
- CluBE (EL)
- ECE d.o.o. (SI)
- AMIBIT, energetski sistemi, d.o.o. (SI)
- Mölndal Energi AB (SE)
- Elektro Celje d.d. (SI)
- Municipality of Eordaia (EL)



Project Description

Context.

The RESONANCE project aims at making it as easy as possible to tailor Customer Energy Manager (CEM) solutions for consumer and prosumer customers in different sectors.

CEMs are envisioned to 1) provide a more deterministic demand response which is needed for predictability and optimise consumer benefits with respect to multiple incentives and goals. To achieve this, there is a need for accurate models of the smart appliances and model predictive control techniques to automate the decision-making within the customer premises.

Scope.

The RESONANCE project is creating a software framework for plug-and-play development of solutions for demand-side flexibility management of distributed and small-scale assets.

- Innovative hybrid approach for modelling of flexible assets & baseline loads with minimal human effort
- Easy-to-use solutions for integrating the hybrid models with optimal control algorithms that can be tailored for the given smart appliances, customer preferences and market setting
- Consumer-centric Artificial Intelligence for , Germany, Slovenia, Greece, Sweden, Finland). Each pilot site is acting as a primary development & testing venue for one to several types of services. The results are populated to the Framework and used to replicate the services in other pilot settings with different stakeholders and constraints.

The CEM represents a fundamental change to the role of consumers and prosumers from passive recipients to active participants in the cross-sector energy ecosystem. In this regard, the CEM concept has the potential to revolutionise demand-side flexibility management and enable new consumer-oriented services.

automated demand response in a plug-and-play manner

- Improved interoperability, trust, security and privacy
- A modular system architecture based on the narrow- waist model for interoperability

Technical description and implementation.

The RESONANCE Framework constitutes 3 catalogues of software libraries as well as marketplace services and tools that provide means for rapid, cost-efficient development & customization of standard-compliant Resource Manager and Customer Energy Manager solutions as well as their aggregation services into different sectors.

- Resource Manager Catalogue
- Customer Energy Manager Catalogue
- Aggregation & Market Integration Catalogue
- Data & Service Marketplaces

Impact.

Demonstrating the RESONANCE services at pilot sites in 6 European countries (France

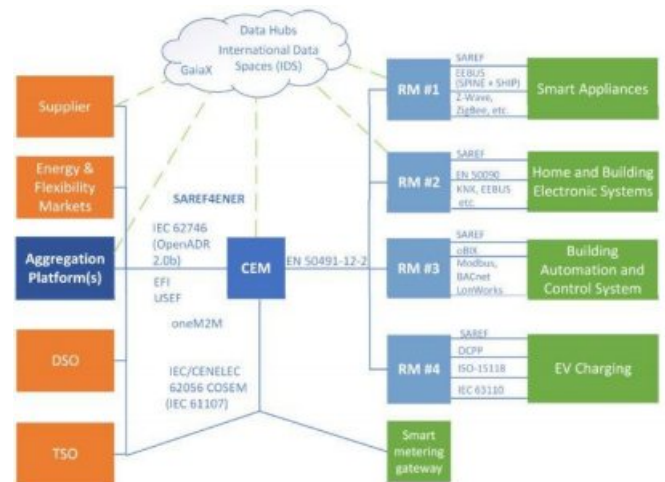



HORIZON-CL5-2022-D3-01-13: Energy system modelling, optimisation, and planning tools

[Back to projects' list](#)

MOPO

Comprehensive, Fast, User-Friendly and Thoroughly Validated Open-Source Energy System Planning Framework



The Mopo project aims to develop a feature-rich energy system modelling toolset to serve a wide range of users from network operators to public authorities, supporting the transition to a 100% sustainable and resilient European energy system.

From 2023	Project total cost	EU contribution	Website
To 31/12/2026	6.0 M€	6.0 M€	TBA

Technologies and services deployed		Project partners' countries
	Technologies for consumers	
	Demand response	
	Grid technologies	
	Large-scale storage technologies	
	Distributed storage technologies	
	Generation technologies	
	Market	
	Batteries	
	Electric Vehicles	
	Wind Turbine	
	PV	
	Electricity markets	
	Energy system modelling	

Coordinator: VTT (Finland)

Other partners:

- Danmarks Tekniske Universitet (Denmark)
- Nederlandse Organisatie voor toegepastnatuurwetenschappelijk onderzoek (Netherlands)
- Katholieke Universiteit Leuven (Belgium)
- University College Dublin (Ireland)
- Kungliga Tekniska högskolan (Sweden)
- Stichting Netherlands eScience Center (Netherlands)
- EPRI Europe DAC (Ireland)
- Energy Reform ltd. (Ireland)
- Ministerie van Infrastructuur en Waterstaat (Netherlands)
- Vlaamse Instelling voor Technologisch Onderzoek (Belgium)
- Fondazione ICONS (Italy)
- Fluxys Belgium SA (Belgium)
- Fortum Power and Heat Oy (Finland)



Project Description

Context and scope. End-to-end energy system modelling is a key enabler in the planning of a 100% sustainable and resilient energy system. The European green transition towards 2050 requires development of energy system modelling capabilities beyond current state-of-the-art, for example by analysing a wider set of scenarios with full sectoral coverage, and including a higher level of detail when planning investments. The Mopo project combines *component tools* producing input data to create model-ready datasets, *scenario and workflow management*, and medium and long-term *energy system planning* to provide a user-friendly, open-source and validated set of tools to benefit decision-makers in network operation, industry and public authorities.

Technical description and implementation. The Mopo project builds on a set of new and already established tools, with a focus on improving interoperability, usability, computational speed and visualisation capabilities. The key components developed within the project include:

- **Component tools and data.** The component tools use open-access data sources to create system models at a user-chosen level of detail, scope, and aggregation. They include tools and data for variable renewable energy, hydropower, networks, conversion and storage, and end-use sectors.
- **System tool.** The system tool – Spine Toolbox – allows flexibly managing workflows, linking data with different modelling tools, controlling data, and building and visualizing scenarios.
- **Planning tool.** The planning tool – SpineOpt – enables co-modelling of resilient pathways for all energy sectors in sector specific detail. It aims to be both easy-to-use for new users and beyond state-of-the-art in capabilities.

Additionally, the project will develop an open certification process, and the tools will be validated and demonstrated

in an industrial (Netherlands-Belgium-Germany) and a Pan-European case study. Close attention is paid to include end-users in the development process and adaptation of the tools.

Impact.

Replicability: All Mopo tools are fully open-source providing regional, national and European public authorities and network operators customisable open-source models in any given geographical area.

Socio-economics: The wide adaptation of Mopo tools in decision-making could result in significant economic savings in comparison to tools that do not offer the same level of granularity. The societal impacts are reached through lower emissions and lower energy costs, but also through more resilient energy systems that can alleviate very challenging situations arising from natural catastrophes or other rare events.

Environment: The capabilities developed in Mopo tools promote a reduction in CO2 emissions, while keeping the costs of reaching a reliable 100% sustainable energy system as low as possible.

Market Transformation: The Mopo tools can be used to analyse market design, regulation and energy policy options with great precision, and therefore contribute to developing new business models and European markets for new energy services.

Policy: The results of the Mopo project foster the development of new policy strategies and regulations to enhance the performance and sustainability of energy systems at Pan-EU level, and also support decision-making on energy policies at local levels

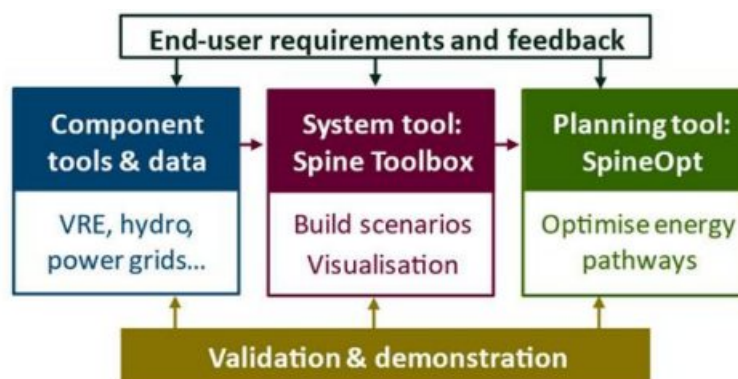



HORIZON-CL5-2022-D3-01-14 Sustainable, secure and competitive energy supply

[Back to projects' list](#)







BEST-Storage

BUILDING ENERGY EFFICIENT SYSTEMS THROUGH SHORT AND LONG SPECTRUM THERMAL ENERGY STORAGE



In BEST-Storage, three conceptually different modular high volumetric energy density storage concepts will be developed and tested in real conditions allowing to decouple power delivered (charging & discharging) and energy stored. This means that none of the storages have heat exchangers inside the vessel where energy is stored. Due to the decoupling of power and energy stored, the storage is inherently modular providing cost savings, flexibility in design, size and operation of a storage systems. In total, four storage solutions will be developed and tested at different TRL levels, one thermo-chemical material (TCM) storage, two PCM slurry solutions and one sensible water storage with vacuum insulation (VI).

From 2023	Project total cost	EU contribution	Website
To 31/12/2026	5.4 M€	4.7 M€	www.best-storage.eu

Technologies and services deployed		Project partners' countries
	Technologies for consumers	
	Grid technologies	
	Large-scale storage technologies	
	Distributed technologies	
	Generation technologies	
	storage	Thermal Energy Storage PV
		Ancillary Services
Coordinator: SOLINTEL M & P SL (SPAIN)		

Other partners:

- FUNDACION TECNALIA RESEARCH & INNOVATION (TECNALIA) (Spain)
- ETHNIKO KENTRO EREVNAS KAI TECHNOLOGIKIS ANAPTYXIS (CERTH) (Greece)
- TECHNISCHE UNIVERSITAT BERLIN (TUB)(Germany)
- FUNDACION TEKNIKER (TEKNIKER) (Spain)
- NEWTON ENERGY SOLUTIONS BV (NEWTON) (Netherlands)
- EUROPEAN HEAT PUMP ASSOCIATION (EHPA) (Belgium)
- AVANZARE INNOVACION TECNOLOGICA SL (AVAN) (Spain)
- MITTETULUNDUSUHING TARTU REGIONI ENERGIAAGENTUUR (TREA) (Estonia)
- GIROA SOCIEDAD ANONIMA (GIR) (Spain)
- OST - OSTSCHWEIZER FACHHOCHSCHULE (Switzerland)
- SCUOLA UNIVERSITARIA PROFESSIONALE DELLA SVIZZERA ITALIANA (Switzerland)



Project Description

Context: Buildings consume most of the world’s electricity and as much as 50% of their consumption is used to cover thermal demands. This excessive high energy demand entails significant negative environmental and economic impacts. Consequently, it is imperative to increase use of demand response strategies that shift electricity use from peak to off-peak periods. The BEST-Storage project is an important step to achieve the goal of peak load reduction, energy saving and energy cost minimization. Moreover, technologies for storing renewables for longer time-spans of months or seasons are scarce and costly and thus not widely used yet. Large amounts of energy are needed for heat supply of buildings in cold winter months, when solar energy is scarce and in general when renewable sources cannot cover the demand.

Scope: In BEST-Storage, long and short-term high-energy density storage solutions will be developed and demonstrated in four demo cases around Europe. A thermo-chemical and loss-free storage technology will be developed as a seasonal storage. Two phase change materials slurry concepts and a vacuum insulated water storage will be developed, for cold and warm applications respectively, with the aim of shifting peak load demands. Finally, storage solutions will be integrated within smart building energy management systems featuring model predictive controls.

Technical description and implementation.

The BEST Storage project will develop the following:

- Long-term Thermo-chemical (TCM) Storage concept in which excess energy from intermittent renewable sources such as PV, solar thermal or wind are stored (see Figure below) to be used later, on coldest winter periods. The storage concept works as a thermally driven sorption heat pump with a very cheap sorption material (aqueous NaOH as thermo-chemical material).

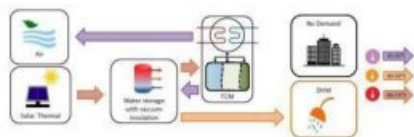

In summer operation (see Figure below left), the thermo-chemical material (TCM) storage can also provide cooling if required. The cold production matches with a discharge of the TCM storage. Charging of the TCM storage before the heating season will occur either in autumn or, thanks to the integrated buffer tank, during summer nights. In winter (see Figure below right), the TCM storage is designed to supply space heating demands for at least 4 weeks.



mass transfer rate by 50 %, reduce the vessel volume by 30 % increasing the energy density by 50% while reducing the storage cost per kWh by 10 % in comparison to current TCM storage design.

- PCM Slurry Storage based on a phase change material (PCM) slurry system able to store energy at around 6-12 °C with an energy density in the range of 17 - 35 kWh/m³. The PCM slurry storage will act as a daily storage allowing to cover peak cooling loads for a few hours shifting in this way electricity consumption to times where electricity is cheap.



- Control Algorithms: The storage systems will benefit from smart control systems that will be integrated into the building energy management system (BEMS).

Impact. Replicability: All storage technologies are conceived as modular due to their ability to decouple power requirements from energy stored by eliminating heat exchanger concepts inside the storage vessels, facilitating thus scalability and design while reducing manufacturing cost.

Socio-economics: Model predictive control algorithms will use electricity prices to decide whether shifting heating and cooling demands on peak to off-peak times is rewarded economically. With such control modules, prosumer business models will be developed leveraging the potential of peak load management and the developed control algorithms.

Environment: Excessive high energy demand entails significant negative environmental impacts (increasing the output of gas-fired generators). The implementation of BEST-Storage optimal control-based operating strategies allows taking full advantage of storage integration in terms of reducing the peak of the electrical demand, smoothing the fluctuations given by uncertain generation from variable renewable energy sources, and enhancing the efficiency of the energy systems.

Market Transformation: The BEST-Storage project leverages modern digital utility market transformations. The implementation of optimal control-based operating strategies and Model Predictive Controls (MPC) based on aggregated energy system data lies as the centrepiece for positioning the developed heating and cooling storage hardware solutions as swiftly applicable modules for new energy services based around flexibility, network optimization and reduced costs, peak shaving/displacement, and energy savings.



HORIZON-CL5-2022-D3-01-14 Sustainable, secure and competitive energy supply

[Back to projects' list](#)





THUMBS UP

Thermal energy storage solutions to optimally Manage Buildings and Unlock their grid balancing and flexibility Potential



THUMBS UP aims to develop and demonstrate thermal energy storage (TES) at daily and weekly level solutions to be easily integrated in EU buildings to increase their energy efficiency as well as to exploit Power-to-Heat approaches.

From 2022	Project total cost	EU contribution	Website
To 2025	7.6 M€	6.4 M€	https://www.thumbsupstorage.eu/

Technologies and services deployed	Project partners' countries
 Technologies for consumers Demand response Smart appliances  Grid technologies Network monitoring and control tools  Distributed storage technologies Thermal energy storage	

Coordinator: VEOLIA SERVICIOS LECAM SOCIEDAD ANONIMA UNIPERSONAL (LE)

Other partners:

- FUNDACIÓN CARTIF (Spain)
- UNIVERSITA DEGLI STUDI DI GENOVA (Italy).
- CONSIGLIO NAZIONALE DELLE RICERCHE (Italy).
- UNIVERSIDAD DE LLEIDA (Spain).
- algoWatt SpA (Italy).
- PLUSS ADVANCED TECHNOLOGIES BV (Netherlands)
- SORPTION TECHNOLOGIES GMBH (Germany)
- GRADYENT B.V. (Netherlands)
- ETHNIKO KENTRO EREVNAS KAI TECHNOLOGIKIS ANAPTYXIS (Greece).
- JOHANNEBERG SCIENCE PARK AB (Sweden).
- I-TES SRL (Italy).
- GRID SINGULARITY GMBH (Germany).
- UNIVERSITA DEGLI STUDI DI MESSINA (Italy).
- KELVIN BV (Netherlands).
- UBITECH ENERGY (Belgium).
- NANOPHOS ANONIMI EMPORIKI ETAIRIA ANAPTIXIS KAI YPIRESION - NANOPHOS COMMERCIAL SOCIETE ANONYME OF SERVICES AND DEVELOPMENT (Greece).
- THE ECONOMIC AND SOCIAL RESEARCH INSTITUTE LBG (Ireland).
- POLITECNICO DI TORINO (Italy).
- THE UNIVERSITY OF BIRMINGHAM (United Kingdom).



Project Description

Context: Nowadays in Europe Heating and Cooling (HC) is the single largest source of energy demand and CO2 emissions in Europe, and almost a half of this demand comes from buildings. Electrifying HC systems is the current trendy option to integrate renewable energy sources (RES) to heating and cooling buildings, but a step further is needed. The THUMBS UP consortium is composed of different kinds of companies aiming to develop systems to increase the energy efficiency of buildings and take full advantage of RES.

Scope: THUMBS UP is such a challenging project. Its main objective is to develop and deploy technologies and systems that will gradually unlock the zero-carbon electrification of residential H&C. Power-to-heat (Pth) solutions are already available in the market, but other important objective is to improve these solutions with different Thermal Energy Storage (TES) technologies. Two innovative technologies will be developed in a larger scale by R&D partners in partnership with current TES technology producers, in order to be cost-effective and to covering the needs for daily/weekly-duration storages. The short-term storage (called FractLES) and the long-term storage (sorTES) developed technologies will be validated in a validation demosite and then deployed in three real demosites (different categories of residential buildings) to evaluate their usefulness and how they increase the energy efficiency of the building. BEMS (building energy management system) will be also deployed to gather data about the performance of the technologies, and will determine if the systems are properly working or not using KPIs previously defined. Finally, some virtual tools will be used to coordinate the system in the building with a DHN operation and with the electrical grid to obtain the maximum possible profit of the technology.

Technical description and implementation: The project will consist of three different stages:

- During Phase A the “FractLES” (3-10s kWh stored, PCM-phase changing materials) and “sorTES” (9–100s kWh stored, TCM-thermochemical materials) technologies will be developed in parallel by the R&D partners.
- Phase B will be the stage in which the technologies will be integrated with the BEMS. Then, they will be validated (TRL 6 level) and deployed in real demo sites (TRL 7) with different characteristics, purposes and climate conditions.
- In the last stage, Phase C, the behavior of the technologies will be modelled and some replication studies based in digital tools will be carried out in different virtual demo sites.

Impact: Replicability: The demonstration sites’ locations and typologies were initially selected to cover a large range of potential usages of the technologies. With basis in the expertise gained in the demonstrators, and through the usage of digital tools, the replicability potential will be evaluated in 5 virtual demo sites.

Socio-economics: The THUMBS UP solutions aim to reduce the cost of HC as the dependence on fossil-fuels will be lower. Due to that, the energy poverty would be reduced, but also the emissions. Thus, productivity will increase and, regarding healthiness, respiratory diseases will be consequently reduced.

Environment: the project will contribute to the SDGs 7, 11 and 13, because of the expected reduction of GHG emissions. Besides, the raw materials involved in the fabrication of “fractLES” and “sorTES” are planned to be environmentally friendly. Last but not least, an environmental LCA will be performed to test the potential impacts of THUMBS UP solutions.

Market Transformation: The current position of Pth solutions and low carbon H&C trends are giving to TES solutions a great opportunity to join the market with a strong position, even stronger because of the big cost of electrical batteries with the same purpose.

Policy: Within initiatives as CELSIUS and BRIDGE, THUMBS UP will promote policies and recommendations to eliminate barriers and obstacles for the development of TES solutions replication after the project.

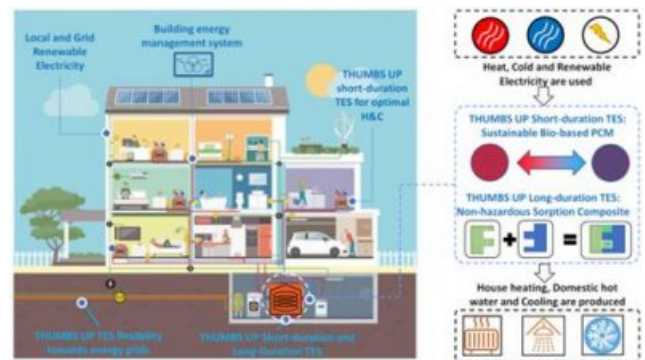

**HORIZON-CL5-2022-D3-01-14: Thermal energy storage solutions**[Back to projects' list](#)

ECHO

EFFICIENT COMPACT MODULAR THERMAL ENERGY STORAGE SYSTEM



The project's goal is to develop and demonstrate a novel modular, compact, high performances and Plug&Play thermal energy storage (TES) solutions for heating, cooling and hot tap water production. The new concept of TES proposed in the project will provide electricity load shifting with meaningful peak shaving of the thermal and electric load demands.

From 2023	Project total cost	EU contribution	Website
To 31/12/2026	7 M€ (8M€ with UK)	6 M€	https://echo-euproject.eu

Technologies and services deployed**Project partners' countries****Technologies for consumers**

Demand response
Smart appliances
Smart metering

**Grid technologies**

HVAC
Network, management,
monitoring and control
tools

**Large-scale storage technologies****Distributed storage technologies**

Thermal Energy Storage

**Generation technologies**

PV
Solar Thermal

**Coordinator: CNR (Italy)****Other partners:**

- BEWARRANT (Belgium)
- UNIVERSITA DEGLI STUDI DI FERRARA (Italy)
- UNIVERSITAT POLITECNICA DE VALENCIA (Spain)
- INSTITUT MIHAJLO PUPIN (Serbia)
- FUNDACION TECNALIA RESEARCH & INNOVATION (Spain)
- ISTANBUL TEKNIK UNIVERSITESI (Turkey)
- SANHUA INTERNATIONAL EUROPE SL (Spain)
- UNIVERSITA DEGLI STUDI DI PADOVA (Italy)
- GREEN ENERGY SOLUTIONS CONSULTANT SRL (Romania)
- HIREF SPA (Italy)
- EUROPEAN HEAT PUMP ASSOCIATION (Belgium)
- IDEAKIM KIMYA INSAAT ITHALAT IHRACAT SANAYI AS (Turkey)
- GEMINIS TOOLS S.L. (Spain)
- GENERACION DE ENERGIAS ALTERNATIVAS SL (Spain)
- PHASE CHANGE MATERIAL PRODUCTS LTD (UK)
- THE UNIVERSITY OF NOTTINGHAM (UK)

Project Description

Context. Energy storage is one of the key factors to reach EU aims to be climate-neutral by 2050, with a net-zero greenhouse gas (GHG) emissions economy. Although global energy demand will rise, due to the economic development and the population increase, the EU ambitious target to reduce GHG emissions is pushing towards a severe change in the employed energy systems, through decarbonisation and with the transition to clean energy sources and the improvement of the energy efficiency. The need to develop a flexible energy system, managing the intrinsically intermittent nature of renewable energy sources as well as grid electricity production and demand, finds a solution in the potentialities of thermal energy storage (TES) systems, able to provide electricity load shifting by mean of energy conversion and storage. ECHO solutions will be flexible and adaptable to different end-user requests, in terms of charging (and discharging) power, dimension and types of energy sources.

Scope. ECHO project will provide a key tool for thermal energy storage in the context of sector coupling and provision of flexibility of demand. The specifications and characteristics of the ECHO system will be adapted to the energetic scenarios in which they will be applied. Additionally, its modularity will allow to use the concept in different scales, from small apartments to larger buildings. The developed systems will be adaptable to different energy sources and user demands, setting more suitable configuration parameters. They will be feasible to be charged directly by means of an internal heat pump, exploiting the electricity overproduction from the grid, or directly connecting to renewable energy sources installed in the building.

Technical description and implementation. The overall methodology will follow a full approach from research over innovation to demonstration and evaluation. Communication, dissemination and exploitation of results will run in parallel over the project.

- First, an analysis of the different energy scenarios in Europe and of the building stock characterisation will individuate the fundamental parameters, the boundary conditions and the constraints for the TES design. The TES solutions will be preliminary conceptualised to be adaptable depending on the final requirements.
- Then, storage materials (TCMs, PCMs, ice) and related reactors will be finely designed, optimized and integrated in the building thermal system.
- Once the solutions will be realized at lab scale and successfully tested, the project will move into an extensive demonstration phase at real scale.
- The results will be evaluated, being a solid basis for market planning, training events, workshops and dissemination activities.

The project results will be validated in a first lab prototype and then in three different demo sites, in Italy, Serbia and Belgium.

Impact. ECHO will demonstrate the impact of TES on European Society, through the exploitation of different materials and technologies, simulating a wide use of these systems in the future.

Replicability: ECHO TES device can be sized according to the demand profile of the building, the supply profile of the renewable energy sources and the available space. The installation of three different demo sites in three different countries and building types, together with simulations of TES employment in two different cities (Bilbao and Valencia) and a dedicated simulator (ECHOTSS), based on Multiagent Simulation to characterize the effect of small-scale storage aggregation strategies in realistic grid operations, will prove the replicability of the system.

Socio-economics: The different approaches employed in ECHO will allow for grid-scale integration and maximisation of TES impact on the flexibility/balancing markets, thus providing critical benefit for the grid operators, as well as socio-economic welfare of end users/building owners.

Environment: The innovative ECHO TES solutions will contribute to the mitigation of climate change, the reduction of greenhouse gases (GHG) emissions, pollution prevention and reduction, the energy peak load shaving and costs avoidance.

Market Transformation: The role of citizens and communities is a key factor in the project, increasing the awareness of people on the importance of flexibility and energy load shifting at appliance level available for the energy grid. All the necessary actions will be done to build the social acceptance of new energy technologies and increase participation of consumers in energy markets. Dedicated surveys will be directed to citizens and communities to understand how to penetrate the market, overcoming the obstacles related to this technology, also considering any gender, economic and social differences.

Policy: ECHO TES functioning, integrated by the ECHOTSS (to test how individual small-scale systems can operate synchronically in different markets) will increase awareness of policy makers on the capabilities of TES systems to reduce GHG emissions and enhance energy system resilience. ECHO results can help in the energy transition, informing EU citizens and policy bodies about the positive implication of TES use.

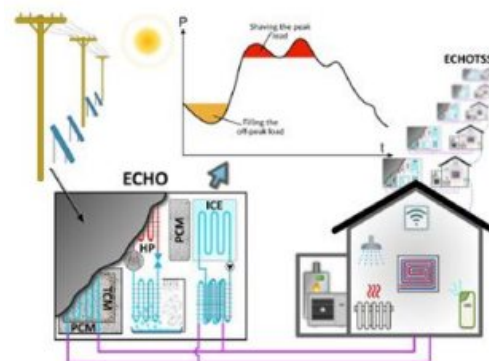

**HORIZON-CL5-2022-D3-01-14: Thermal energy storage solutions**[Back to projects' list](#)







HYSTORE



Hybrid services from advanced thermal energy storage systems

The mission of HYSTORE is to develop and validate four innovative sets of TES concepts, based on PCM and TCM solutions. The four novel concepts attain different applications on heating/cooling (H/C), DHW configurations, and further set up optimal conditions for the provision of hybrid – meaning energy and power services thanks to the development of a smart aggregator and an open-source multi-service platform.

From 2023	Project total cost	EU contribution	Website
To 31/12/2026	8.8 M€	7.3 M€	https://hystore.eu/

Technologies and services deployed	Project partners' countries
 Technologies for consumers Demand response Smart appliances	
 Grid technologies	
 Large-scale storage technologies	
 Distributed storage technologies	
 Generation technologies	
Coordinator:	SHORT NAME (country)

Other partners:

- CONSIGLIO NAZIONALE DELLE RICERCHE (Italy)
- KUNGLIGA TEKNISKA HOEGSKOLAN (Sweden)
- RUBITHERM TECHNOLOGIES GMBH (Germany)
- AIT AUSTRIAN INSTITUTE OF TECHNOLOGY GMBH (Austria)
- OCHSNER WARMEPUMPEN GMBH (Austria)
- PINK GMBH (Austria)
- SORPTION TECHNOLOGIES GMBH (Germany)
- INOVA LAB (Italy)
- STAM (Italy)
- MASTON AB (Sweden)
- DUBLIN CITY UNIVERSITY (Ireland)
- ACCADEMIA EUROPEA DI BOLZANO (Italy)
- R2M SOLUTION (Italy)
- UNIVERSITY COLLEGE DUBLIN (Ireland)
- CENTRAL DE RESERVES DE MONTSERRAT
- RAAL (Romania)
- EUROPEAN INNOVATION MARKETPLACE (Ireland)



Project Description

Context.

Despite the increasing interests in developing and implementing thermal energy storage (TES) in energy sectors, there is still not enough data available on the impact of TES technologies, or the actual installed capacity of storage. Such aspects have been already highlighted as a critical issue by IRENA roadmaps.

Historically, TES systems have been considered mainly as an auxiliary component for the energy systems at user levels, and only very recent developments have identified TES as an asset for centralized energy generation.

Scope.

The mission of Hystore is to develop and validate an innovative set of TES concepts, based on the combination of cutting-edge technology components, namely, ALL-IN-ONE PCM solution, LOW-TEMP PCM HEATING&COOLING solution, PCM HEATING solution and TCM HEATING&COOLING solution. The four novel concepts – attain different but thorough applications on heating/cooling (H/C), DHW configurations, and further set up optimal conditions for the provision of hybrid – meaning energy and power- services. The main objectives are:

Technological advancement of thermal energy storage (TES) with up to +150% energy density and -50% CAPEX compared to state-of-art (SoA)

Significant lower design and installation effort thanks to pre-defined and standardized guidelines

To allow TES to be coupled and integrated with grid-level aggregators that can be federated in the context of both single buildings and local energy communities

4 use case application in different climates both for DHC (District Heating/Cooling) connected and non DHC-connected buildings with high-impact and replication potential. LCOS in line with EU targets from IRENA annual reports and SET-plan.

Technical description and implementation. XXX

Hystore methodology relies on five inter-related development lines:

Technical development of storage systems:

Development of solutions for short-term and mid-term thermal energy storage suitable for heating, cooling and DHW but tailored for different climate and regulatory or user scenarios. The solutions include: PCM storage (for daily storage) and TCM storage (for monthly storage). In particular, 3 PCM storage solutions will be developed, tailored for different applications: heating-dominant loads, cooling- dominant loads and cases where both heating and cooling with high efficiency need to be provided. The development is carried out by research centres/universities in close collaboration with well-established industrial partners.

Technical development of control and management systems: Hystore develops and deploys innovative ICT solutions that cover both software and hardware service aggregators and ICT architecture. The innovations aims at integrating different TCM system solutions for both building and LEC levels.

Multi-level system integration and adoption: Compilation of guidelines for system integration with both the heating/cooling/DHW distributionsystem of a building and the energy system (at building and grid levels) and training of skilled professionals. This will allow to make the developed solutions as plug-and-play as other widely commercialised systems, such as water tanks and batteries.

Demonstration at TRL 6/7 of the developed solutions in different climates and use case contexts. The validation campaign will be strongly supported by experienced partners so that it will not be just a showcase of technologies but already demonstrates economic and environmental benefits of Hystore.

Exploitation, business and value chain creation:

Definition of innovative business and contractual schemes for Capacity as a Service. Ambition: enable actual and consistent earnings for the various stakeholders due to the deployment of Hystore solutions to provide an actual alternative to grid-linked services for load shifting or peak load reduction that are currently based on electric storage.

Impact. Replicability: 4 pilots targeting 4 different use case applications in DHC connected and non- connected scenarios. Modular, compact and easy-to-install TES. 6-7 patents. Hystore Solutions can be easily transferred to other industrial sectors (e.g. process industry, refrigeration, chemical industries, agro-food).

Socio-economics:

- ✓ Reduction of 20% in energy costs.
- ✓ Exploit at least 5-10% load shifting potential.
- ✓ Exploit demand-response potential of around 15% of peak demand in districts.
- ✓ Maximize self-consumption or collective self-consumption within energy communities via storage solutions.

Environment:

TES systems at TRL 6-7 (5 prototypes) with improved compactness, modularity and higher performance (+120% energy density). Up to 78% in energy savings.

Policy: Advocacy will have the purpose to attract stakeholders to the capacity building program and to look toward national and regional funding programs/incentives to ensure awareness of TES systems for consideration in future programs. LCOS in line with EU targets from IRENA annual reports and SET-plan.

Market Transformation:

A novel Interoperable but modular ICT platform for TES management and aggregation as Demand Response. Novel set of hybrid (energy and power) service



5 Demonstration sites

The table below provides information about the demonstrations' sites from the ongoing projects that can be physically visited⁹ and/or contacted for knowledge sharing:

Please contact the BRIDGE support team for more information: secretariat@h2020-bridge.eu

5.1 Demonstration site's location and contacts

Project	Name of the demonstration	Country	City	Local contact
LC-SC3-ES-3-2018-2020 - Integrated local energy systems (Energy islands)				
LocalRES	LocalRES Pilot	Spain	Ispaster	Iñaki Gaztelu
LocalRES	LocalRES Pilot	Austria	Ollersdorf	Nicolas Pardo-García
LocalRES	LocalRES Pilot	Finland	Kökar	Niko Korpela
LocalRES	LocalRES Pilot	Italy	Berchida	Giulia Carbonari
SERENE	Laasby	DK	Laasby	Susanne Skaarup
SERENE	Hylke	DK	Hylke	Susanne Skaarup
SERENE	Aardehuizen	NL	Aardehuizen	Ferdi Hummelink
SERENE	Vriendenerf	NL	Vriendenerf	Ferdi Hummelink
SERENE	Przywidz	PL	Przywidz	Tomas Herbasz
LC-SC3-ES-4-2018-2020 - Decarbonising energy systems of geographical Islands				
IANOS	IANOS - Terceira	Portugal	Terceira	Nuno Marinho
IANOS	IANOS - Ameland	Netherlands	Ameland	Johan Boekema
MAESHA	MAESHA pilot	France	Mamoudzou	Camelia Bouf
ROBINSON	ROBINSON Pilot	Norway	Eigeroy	Steinar Aamodt
VPP4ISLANDS	Demo site 1	United Kingdom	Neath Port Talbot	Qadrnan MEYSAM
VPP4ISLANDS	Demo site 2	Turkey	GOKCEADA Island	Mr.Mehmet KOÇ
VPP4ISLANDS	Demo site 3	Spain	Formentera Island	Antonio Jesús SANZ IGUAL
LC-SC3-ES-1-2019 - Flexibility and retail market options for the distribution grid				
ebalance-plus	University of Málaga Smart Campus	Spain	Málaga	Manuel Díaz
ebalance-plus	University of Calabria Smart Grid	Italy	Calabria	Anna Pinnarelli
ebalance-plus	University of Calabria Smart Grid	Italy	Calabria	Anna Pinnarelli
ebalance-plus	Denmark summer houses provided by NOVASOL	Denmark	Various	Razgar Ebrahimy
ebalance-plus	Yncrea - Institute Catholic of Lille	France	Lille	Christophe Saudemont
EUniversal	DEMO 1 PORTUGAL	Portugal	several localtions accross Portugal	Mário Teixeira Couto
EUniversal	DEMO 2 GERMANY	Germany	Limbach-Oberfrohna	Carmen Calpe
EUniversal	DEMO 3 POLAND	Poland	Northern part of Poland	Noske Slawomir
FEVER	FEVER-DE	Germany	Hassfurt	Christopher Schneider

⁹ This list was provided by the respective BRIDGE projects. Please contact the BRIDGE support team for any modification, removal, or addition.
TBD - the location or the contact person to be defined.



Project	Name of the demonstration	Country	City	Local contact
FEVER	FEVER-DE	Germany	Wunsiedel	Gerhard Meindl
FEVER	FEVER-ES	Spain	Catalunia Region	Luisa Candido
FEVER	FEVER-CY	Cyprus	Nicosia	Christina Papadimitriou
FLEXIGRID (864579)	Demo 1 Spain	Spain	Santander	Antonio González
FLEXIGRID (864579)	Demo 2 Greece	Greece	Thasos	Panos Papadopoulos
FLEXIGRID (864579)	Demo 3 Croatia	Croatia	Zagreb	Josko Graso
FLEXIGRID (864579)	Demo 4 Italy	Italy	Bolzano	Marco Baldini
Platone	German Demo	Germany	TBD	Benjamin Petters
Platone	Italian Demo	Italy	Rome	Ercole De Luca
Platone	Greek Demo (Mesogia)	Greece	Mesogia	Stavroula Tzioka
X-FLEX	Albena AD	Bulgaria	Albena	Stanev Dimitar
X-FLEX	Xanthi	Greece	Xanthi	HEDNO SA.
LC-SC3-ES-2-2019 - Solutions for increased regional cross-border cooperation in the transmission grid				
TRINITY	Management and coordination of regional structures pilot scenario	Bosnia and Herzegovina, Montenegro, Serbia, North Macedonia and Bulgaria	TBD	Dusan Presic
TRINITY	RES pilot scenario	Serbia, Greece, Montenegro, Bosnia and Herzegovina, Croatia, North Macedonia, Bulgaria and Hungary.	TBD	Stjepan Sucic
FARCROSS	Unlocking Cross-Border Capacity with Modular Power Flow Control Solutions (MPFC DEMO)	Greece, Bulgaria	TBD	Mark Norton
FARCROSS	Implementation of a Wide-Area Protection, Automation and Control system (WAMPAC) applied to Cross-Border Transmission Systems (WAMS DEMO)	Greece, Bulgaria	TBD	Eduardo Martinez Carrasco
DT-ICT-10-2018-19 - Interoperable and smart homes and grids				
InterConnect	French pilot	France	Toulon	Stéphane Vera
InterConnect	Portuguese pilot	Portugal	TBD	José Manuel Terras
InterConnect	Local Energy Communities	Belgium	Distributed over Flanders	Leen Peeters
InterConnect	Dutch Pilot	Netherlands	Eindhoven	Wouter Beelen
InterConnect	Italian pilot	Italy	Milan	Stefano Fava
DT-ICT-11-2019 - Big data solutions for energy				
BD4OPEM	Estabanell & Pahisa s.a	Spain	Granollers	Ramon Gallart Fernandez
BD4OPEM	Elektro Celje	Slovenia	Celje	Anton Kos
BD4OPEM	Osmangazi Electric Distribution Inc.	Turkey	TBD	Ural Halaçoğlu
BD4OPEM	Vrije Universiteit Brussel	Belgium	Brussels	Maarten Messagie
BD4OPEM	Nuvve	Denmark	Bornholm	Mogens Løkke
LC-SC3-EC-3-2020: Consumer engagement and demand response				



Project	Name of the demonstration	Country	City	Local contact
ACCEPT	Aspra Spitia Community - Viotia	Greece	Aspra Spitia	Vavouris Alexander
ACCEPT	Renewable Energy Cooperative Buildings - Murcia	Spain	Murcia	Antonio Soler
ACCEPT	Eva Lanxmeer Community - Culemborg	Netherlands	Culemborg	Gerlach Velthoven
ACCEPT	Motta Massagno District - Lugano	Switzerland	Massagno	Paolo Rossi
BRIGHT	Pilot Site 1	Belgium	Ghent	Chaim De Mulder
BRIGHT	Pilot Site 2	Slovenia	TBD	Gregor Novak
BRIGHT	Pilot Site 3	Italy	Terni	Francesca Santori
BRIGHT	Pilot Site 4	Greece	Thessaloniki, Chalkidiki, Volos	Kostantinos Arvanitis
HESTIA	Berchidda Municipality	Italy	Berchidda	Marta Amiani
HESTIA	Camille Claudel Eco-District	France	City of Palaiseau	Mathieu Schumann
HESTIA	Voorhout Village	Netherlands	Voorhout	Adriaan Harthoorn
iFLEX	iFLEX Finnish Pilot Cluster	Finland	Kerava and Oulu	Olli Nummelin
iFLEX	iFLEX Slovenian Pilot Cluster	Slovenia	Kozjansko and Savinjska dolina	Gašper Ravnak
iFLEX	iFLEX Greek Pilot Cluster	Greece	Athens, Thessaloniki and Volos	Maria Sakali
REDREAM	Spanish Demo	Spain	Valladolid	RODRIGO JOSE RUIZ GARCIA
REDREAM	Italian Demo	Italy	Gallese	ANDREA FERRANTE
REDREAM	UK Demo	UK	Mendip Area	ALISON TURNBULL
REDREAM	Croatian Demo	Croatia	Varaždin	LUCIJA NAD
SENDER	ALGINET	SPAIN	ALGINET	Alma Solar
SENDER	WEIZ	AUSTRIA	WEIZ	Andrea Domhofer
SENDER	VTT	FINLAND	ESPOO	Kari Mäki
TwinERGY	Pilot Demonstration in Germany	Germany	Hagedom Village, Steinheim, North Rhine-Westphalia	Johannes Üpping
TwinERGY	Pilot Demonstration in Greece	Greece	Athens	Spyros Liarmakopoulos
TwinERGY	Pilot Demonstration in Italy	Italy	Benetutti	Rosolino Sini
TwinERGY	Pilot Demonstration in United Kingdom	UK	Bristol City	Freyia Lockwood
LC-SC3-ES-3-2018-2020: Integrated local energy systems (Energy islands)				
REnergetic	Pilot site 1: Ghent – New Docks	Belgium	Ghent	Lieven DEMOLDER
REnergetic	Pilot site 2: Poznan – Warta Campus	Poland	Poznan	Radoslaw Gorzenski
REnergetic	Pilot site 3: Segrate – Hospital and research campus	Italy	Milan	Daniele Baranzini
LC-SC3-ES-10-2020 - DC – AC/DC hybrid grid for a modular, resilient and high-RES share grid development				
HYPERRIDE	HYPERRIDE DEMO 1	Switzerland	Lausanne	Drazen Dujic
HYPERRIDE	HYPERRIDE DEMO 2	Germany	Aachen	Shenghui Cui
HYPERRIDE	HYPERRIDE DEMO 3	Italy	Terni	Massimo Cresta
TIGON	CEA INES platform	France	Le Bourget-du-Lac	Anthony BIER
TIGON				Olivier WISS
TIGON	CIEMAT Centre for the Development of Renewable Energy Sources	Spain	Madrid	Oscar Izquierdo Monge
LC-SC3-ES-4-2018-2020: Decarbonising energy systems of geographical Islands				
IANOS	IANOS - Terceira	Portugal	Terceira	Nuno Marinho



Project	Name of the demonstration	Country	City	Local contact
IANOS	IANOS - Ameland	Netherlands	Ameland	Johan Boekema
MAESHA	MAESHA pilot	France	Mamoudzou	Camelia Bouf
ROBINSON	ROBINSON Pilot	Norway	Eigeroy	Steinar Aamodt
VPP4ISLANDS	Demo site 1	UK	Neath Port Talbot	Qadrnan MEYSAM
VPP4ISLANDS	Demo site 2	Turkey	GOKCEADA Island	Mehmet KOÇ
LC-SC3-ES-13-2020 - Integrated local energy systems (Energy islands): International cooperation with India				
SUSTENANCE	Stjaer	Denmark	Stjaer	Susanne Skaarup
SUSTENANCE	University of Twente	Netherlands	Twente	Frans Coenen
SUSTENANCE	Sopot	Poland	Sopot	Marcena Zapoleta
SUSTENANCE	Barbeda	India	Jharkhand	Zakir Rather
SUSTENANCE	Borakhai	India	Assam	Zakir Rather
SUSTENANCE	Indian Institute of Technology	India	Bombay	Zakir Rather
RE-EMPOWERED	Bornholm Island	Denmark	–	Andreas Søgaard
RE-EMPOWERED	Kythnos Island	Greece	–	Alkistis Kontou
RE-EMPOWERED	Keonjhar	India	–	Srinivas Karanki
RE-EMPOWERED	Ghoramara Island	India	–	Suman Maiti
HORIZON-CL5-2021-D3-01-01: Establish the grounds for a common European energy data space				
Data Cellar	'Igniting' the energy community 'engine'	Bulgaria	Sofia	Angel Markov
Data Cellar	'Igniting' the energy community 'engine'	Bulgaria	Sofia	Pencho Zlatev
Data Cellar	Eunice Use Case (Temporary)	Greece	Attiki	Stergios Kokorotsikos
Data Cellar	Eunice Use Case (Temporary)	Greece	Attiki	Spyros Kokkolios
Data Cellar	Eunice Use Case (Temporary)	Greece	Attiki	Nikos Skordoulis
Data Cellar	Eunice Use Case (Temporary)	Greece	Attiki	Dimitris Rachiotis
Data Cellar	CFOAT Use Case (Temporary)	Ireland	Arana Island	Avril Ní Shearcaigh
Data Cellar	Cascais Village	Portugal	Cascasis	João Dinis
Data Cellar	Rural Energy Community of Moal	Spain	Moal, Cangas del Narcea, Asturias, Spain	Indalecio González Fernández
Data Cellar	Arena Innovation Community	Switzerland	Capriasca, Switzerland	Daniele Farrace
Data Cellar	Casa Girasole	Switzerland	Massagno, Switzerland	Daniele Farrace
Data Cellar	Energy Community in rural area	Italy	North-West Italy	Gianluce Serale
Data Cellar	Energy Community in rural area	Italy	North-West Italy	Ilaria Vina
EDDIE	Ötzi Strom Energy Co-operative	Italy	Bolzano	Andreas Thaler
EDDIE	DEDA Energy Island	Greece	Tba	Manolis Zafeiris
EDDIE	Digital4Grids	France	Paris	Laurent Schmitt
OMEGA-X	Renewables	Spain	TBD	Laura García
OMEGA-X	Renewables	France	TBD	Philippe Calvez
OMEGA-X	Local Energy Communities	Spain	TBD	Ramon Gallart
OMEGA-X	Local Energy Communities	Spain	TBD	Filipe Silva
OMEGA-X	Local Energy Communities	Italy	TBD	Sara Frusone
OMEGA-X	Local Energy Communities	Serbia	TBD	Marko Batic



Project	Name of the demonstration	Country	City	Local contact
OMEGA-X	Electromobility	Germany	TBD	Michiel Verbeeck
OMEGA-X	Electromobility	Belgium	TBD	Florian Mancel
OMEGA-X	Flexibility	Portugal	TBD	Filipe Neves Silva
SYNERGIES	DIACHEIRISTIS ELLINIKOU DIKTYOU DIANOMIS ELEKTRIKIS ENERGEIAS AE	Greece	Mesogeia	Eleni Daridou
SYNERGIES	INDEPENDENT POWER TRANSMISSION OPERATOR SA	Greece	Mesogeia	Epameinondas Floros
SYNERGIES	CUERVA ENERGÍA SLU (formerly MONTAJES ELECTRICOS CUERVA S.L)	Spain	Fomes	Jorge Rueda Quintanilla
SYNERGIES	TREFOR EL NET OST AS	Denmark	Bornholm	Hans Henrik Ipsen
HORIZON-CL5-2021-D3-02-01: Demonstration of wave energy devices to increase experience in real sea condition				
WEDUSEA	EMEC	United Kingdom	Stromness	Carly Tait
HORIZON-CL5-2021-D3-02-05 Energy Sector Integration: Integrating and combining energy systems to a cost-optimised and flexible energy system of systems				
SENERGY NETS	District heating of Milan	Italy	Milan	Alessandro Cirocco
SENERGY NETS	City of Ljubljana	Slovenia	Ljubljana	Christoph Gutschi
SENERGY NETS	Îlot Gaité Montpamasse	France	Paris	Benoit Descleves
ELEXIA	The Port of Sines	Portugal	Sines	Eduardo Bandeira
ELEXIA	Høje-Taastrup	Denmark	Høje-Taastrup	Morten Koed Rasmussen
ELEXIA	Dokken	Norway	Bergen	Laura Ve
FEDECOM	FEDECOM Pilot 1	Spain	Ur Beroa	Iván Pasarín
FEDECOM	FEDECOM Pilot 2	Spain	Puertollaro	Carlos Fúnez
FEDECOM	FEDECOM Pilot 3	Switzerland	Lugaggia, Motta Masagno, Garamé	Federico Giani
FEDECOM	FEDECOM Pilot 4	Belgium	Brussels and Dordrecht	Sofyan Mimouni
HORIZON-CL5-2021-D3-02-06: Increasing energy system flexibility based on sector-integration services to consumers (that benefits system management by DSOs and TSOs)				
BeFlexible	SOUTHMID EU	Italy	Rome	Ercole De Luca
BeFlexible	SOUTHMID EU	Italy	Foggia & Benevento	Carolina Manaresi
BeFlexible	SOUTHMID EU	Italy	Cuneo, Milano	Carolina Manaresi
BeFlexible	NORTH EU	Sweden	Southern Sweden	Clemens Gerbaulet
BeFlexible	NORTH EU	Sweden	Southern Sweden	Clemens Gerbaulet
BeFlexible	SOUTH-WEST EU	Spain	Madrid	Beatriz Alonso Santos
BeFlexible	SOUTH-WEST EU	Spain	Bilbao	Beatriz Alonso Santos
BeFlexible	SOUTH-WEST EU	Spain	Benidorm	Beatriz Alonso Santos
BeFlexible	SOUTH-WEST EU	Spain	Zaragoza	Daniel Davi
BeFlexible	SOUTH-WEST EU	France	Mougins	Jean-Christophe Pazzaglia
BeFlexible	SOUTH-WEST EU	France	Caen	Jean-Christophe Pazzaglia
ENFLATE	ENFLATE Demo Site #1	Greece	Skiathos island	Yiannis Vlachos
ENFLATE	ENFLATE Demo Site #2	Switzerland	Appenzell	Christoph Imboden
ENFLATE	ENFLATE Demo Site #3	Spain	Lachar	Marian Gallego
ENFLATE	ENFLATE Demo Site #4	Sweden	Kungsbacka	Nathalie Fransson
ENFLATE	ENFLATE Demo Site #5	Bulgaria	Dragalevtsi	Mariya Angelova
ENFLATE	ENFLATE Demo Site #6	Switzerland	Geneva	Jeroen Beukers



Project	Name of the demonstration	Country	City	Local contact
STREAM	Smart Lentokapteeni	Finland	Siilinjärvi	VOI
STREAM	Terni	Italy	Terni	ASM
STREAM	Crevillent	Spain	Crevillent	ENER
STREAM	Ajdovščina	Slovenia	Ajdovščina	EPR
HORIZON-CL5-2021-D3-02-07: Reliability and resilience of the grid: Measures for vulnerabilities, failures, risks and privacy				
EFORT	DSO-MicroGrid	Spain	Escúzar	TBD
EFORT	Pan European Transmission Level	Netherlands	Delft	Alex Stefanov
EFORT	Digital Substation	Ukraine	Iltsi	Andriy Grabchuk
EFORT	Remote Distribution Grid	Italy	Sarentino Valley	TBD
R2D2	R2D2 Greek Pilot	Greece	Xanthi	Dimitris Stratiogiannis
R2D2	R2D2 Serbian Pilot	Serbia	Belgrade	Petar Petrovic Dušan Prešić
R2D2	R2D2 Slovenian Pilot	Slovenia	Ljubljana	Jurij Curck
R2D2	R2D2 Spanish Pilot	Spain	Oviedo	Luis Manuel Santos Moro
HORIZON-CL5-2021-D3-02-09: Demonstration of superconducting systems and elpipes				
SCARLET	MVDC HTS cable	Germany	TBD	TBD
SCARLET	MVDC MgB2 cable	France	TBD	TBD
HORIZON-CL5-2021-D3-02-10: Demonstration of advanced Power Electronics for application in the energy sector				
SiC4GRID	SiC4GRID demo	Denmark	Hadsund	Anders Joergensen
HORIZON-CL5-2021-D3-03-10: Innovative foundations, floating substructures and connection systems for floating PV and ocean energy devices				
NATURESEA-PV	Floating mussel farm	Spain	Galicia	Esteban Camacho
NATURESEA-PV	Mutriku Pilot	Spain	Mutriku	Asier Sanz
PLOTEC	PLOTEC Pilot	Spain	Telde, Gran Canaria	Silvia Hildebrandt
HORIZON-CL5-2021-D3-03-12: Innovation on floating wind energy deployment optimized for deep waters and different sea basins (Mediterranean Sea, Black Sea, Baltic Sea, North-east Atlantic Ocean)				
NEXTFLOAT	NEXTFLOAT	France	MISTRAL site	Izan Le Crom
WHEEL	WHEEL DEMO	SPAIN	LAS PALMAS DE GRAN CANARIA	José Sema García-Conde
HORIZON-CL5-2021-D5-01-03: System approach to achieve optimised Smart EV Charging and V2G flexibility in mass-deployment conditions (ZZERO)				
DriVe2X	Medium-term V2B in hotels for VRE harnessing in island network	UK	Isle of Wight	Vincent Wedlock-ward
DriVe2X	Long-term V2B for large facility energy management	Portugal	Maia	Luiz Dias
DriVe2X	V2H integration in consumer and prosumer homes	Hungary	Budapest	Zoltán Székely
DriVe2X	V2G-enabled Smart Energy and Mobility Hub	The Netherlands	Amsterdam	Hugo Niesing
DriVe2X	V2G integration into hybrid AC/DC VRE-rich microgrid	Italy	Terni	Paride D'Ostilio
EV4EU	Integration of V2X in cities and networks	Portugal	São Miguel, Azores	Gisela Mendes
EV4EU	V2X Flexibility in Electricity Markets	Slovenia	Krško; Celje	Andreja Smole
EV4EU	Open V2X Platform with services integration	Greece	Mesogia area	Panagiotis Padiaditis
EV4EU	Smart Parking Lots and DER coordination	Denmark	Risø; Rønne(Bornholm Island)	Haris Ziras
HORIZON-CL5-2022-D3-01-02: Demonstration of innovative materials, supply cycles, recycling technologies to increase the overall circularity of wind energy technology and to reduce the primary use of critical raw materials				
Blades2build	Blades2Build demonstration plant	Spain	TBD	Elena Jimenez



Project	Name of the demonstration	Country	City	Local contact
REEFLEX	Cross-replication demonstrator 2: Greece	Greece	Halkidiki/Thessaloniki	Kanela Karatzia
REEFLEX	Motta District	Switzerland	Massagno	Riccardo Toffanin
REEFLEX	Data Center 1	Bulgaria	Sofia	Plamen Stoyanov
REEFLEX	Data Center 2	Bulgaria	Sofia	Plamen Stoyanov
REEFLEX	Data Center 3	Bulgaria	Montana	Kalina Atanasova
REEFLEX	Non-residential building	SPAIN	Zaragoza	Gregorio Fernandez
REEFLEX	Agri-food industrial facility	SPAIN	Zaragoza	Lucía Garín
REEFLEX	Residential social housing	SPAIN	Zaragoza	Paloma Bozman
REEFLEX	Non-residential building	SPAIN	Zaragoza	Lucía Garín
HORIZON-CL5-2022-D3-01-08: Supporting the action of consumers in the energy market and guide them to act as prosumers, communities and other active forms of active participation in the energy activities				
RESCHOOL	LOCAL ENERGY COMMUNITIES LED BY MUNICIPALITY	Spain	Girona province	Anna Camp, Giulia Torri
RESCHOOL	AMSTERDAM EASTERN DOCKLANDS ENERGY-FLEX COMMUNITY, THE FLEX-CITY PILOT	Netherlands	Amsterdam	Hugo Niesing, Rutger Krabbendam
RESCHOOL	HAMMARBY SJÖSTAD 2.0, MICROGRID PROJECT	Sweden	Stockholm	Jörgen Lööf
RESCHOOL	COLLECTIVE ENERGY COOPERATIVE	Greece	Athens, Rafinha	Alexandros Chronis
COMMUNITAS	Primiero Valley	Italy	San Martino di Castrozza	Simone Canteri
COMMUNITAS	Crevillent	Spain	Crevillent	Isabel Mas
COMMUNITAS	Buurtwarmte	Netherlands	Groningen	Steven Volkers
HORIZON-CL5-2022-D3-01-09: Grid Forming Capability (in support of the offshore strategy)				
InterOPERA	HIL Demonstrator	Netherlands	Delft	Marjan Popov
InterOPERA	HIL Demonstrator	France	Lyon	Xavier Bourgeat
HORIZON-CL5-2022-D3-01-10: Interoperable solutions for flexibility services using distributed energy storage				
INTERSTORE	FZJ	Germany	Julich	Andrea Benigni
INTERSTORE	ENX	Italy	Rome	Alessandra Martino
INTERSTORE	CAP	Portugal	Porto	Pedro Mota
INTERSTORE	CYG	Austria	Lower Austria	Peter Nemceck
PARMENIDES	Energy Community Heimschuh	Austria	Heimschuh	Gregor Taljan
PARMENIDES	Energy Community Gasen	Austria	Gasen	Gregor Taljan
PARMENIDES	KTH Live-In Lab	Sweden	Stockholm	Hatef Madani
HORIZON-CL5-2022-D3-01-11: Demonstration of innovative forms of storage and their successful operation and integration into innovative energy systems and grid architectures				
2LIPP	2LIPP	Denmark	Rønne, Bornholm	Marjo Lahtimo
AGISTIN	Test Site1: FGH-IEE fast charging of electric vehicles application testing	Germany	Kassel	Siddhi Kulkarni, Fraunhofer IEE
AGISTIN	Test Site2: CDR-CIEMAT pumping tests	Spain	Soria	Paula Pena Carro, CIEMAT
AGISTIN	Test Site3: FGH-IWES electrolysis application tests	Germany	Bremerhaven	Christoph Kaufmann, Fraunhofer IWES
AGISTIN	Demo1: AGI-integrated innovative storage for green H2 production	Netherlands	Emmen	Martijn Lunshof, Shell
AGISTIN	Demo2: AGI-integrated innovative storage for large pumping loads	Spain	Maials	Oriol Guell, ICAT
SINNOGENES	Demo Site #1	Portugal	Maia	Pedro Matos
SINNOGENES	Demo Site #2	Spain	Soria	Ángel Hernández



Project	Name of the demonstration	Country	City	Local contact
SINNOGENES	Demo Site #3	Spain	Huesca	Pilar Gascón Zaragoza
SINNOGENES	Demo Site #4	Germany	Herzberg (Elster)	Michael Lockan
SINNOGENES	Demo Site #5	Greece	Ikaria Island	Christos Dikaiakos
SINNOGENES	Demo Site #6	Switzerland	Geneva	Thierry Lassus
HORIZON-CL5-2022-D3-01-12: Replicable solutions for a cross sector compliant energy ecosystem				
GLocalFlex	Flexible & Smart microGrid	Finland	Utajärvi	Vikke Saarelainen
GLocalFlex	Local energy management	Switzerland	Lugano	Claudio Boer
GLocalFlex	Demand Response Programme and Flexibility in rural & urban energy communities	Spain	Two locations	Cesar Valmesad
GLocalFlex	EFM in cluster of buildings	Czech	Kladno/Prague	David Škorňa
GLocalFlex	Consumer groups	France	Clamart	Pascal Chaussumier
OPENTUNITY	OPENTUNITY Greek Pilot	Greece	Mesogia area	Panos Padiaditis
OPENTUNITY	OPENTUNITY Swiss Pilot	Switzerland	Massagno	Daniele Farrace
OPENTUNITY	OPENTUNITY Spanish Pilot	Spain	Municipality of Santa Eulalia de Ronçana and the City of Balenya	Sara Vieira
OPENTUNITY	OPENTUNITY Slovenian Pilot	Slovenia	Portion of the grids of Elektro Primorska (EP) and Elektro Ljubljana (EL).	Tomi Medved
RESONANCE	RESONANCE Pilot	Finland	Helsinki	Olli Nummelin
RESONANCE	RESONANCE Pilot	Sweden	Mölnådal	Erik Nilsson
RESONANCE	RESONANCE Pilot	Germany	Regensburg	Jens Thirmeyer
RESONANCE	RESONANCE Pilot	France	Marseille	Jaikrishnan R Pillai
RESONANCE	RESONANCE Pilot	Slovenia	Celje	Andraž Javemik
RESONANCE	RESONANCE Pilot	Greece	Eordaia	Vassilis Sakas
HORIZON-CL5-2022-D3-01-14 Sustainable, secure and competitive energy supply				
BEST Storage	Oceanic, offices and lab building	Spain	Eibar, Basque country, Spain	Gorka Naveran (GIR)
BEST Storage	Continental, single family house	Estonia	Tartu, Estonia	Hardi Kolli (TREA)
BEST Storage	Mediterranean, single-family house	Greece	Thessaloniki, Greece	Kyriakos Panopoulos (CERTH)
THUMBS UP	CARTIF III - Validation	Spain	Boecillo	Juan Carlos del Castillo García Ismael Lozano-Gabarre
THUMBS UP	Multifamily + DHN	Sweden	Göteborg	Oliver Ingval King
THUMBS UP	Multifamily	Spain	Valladolid	Guillermo Andrés Nieto
THUMBS UP	Single family	Spain	Chañe	Guillermo Andrés Nieto
HORIZON-CL5-2022-D3-01-14: Thermal energy storage solutions				
ECHO	Padova Demo Case	Italy	Padova	Laura Fedele
ECHO	Belgrade Demo Case	Serbia	Belgrade	Marko Batic
ECHO	Putte Demo Case	Belgium	Putte	Luc Pockele
HYSTORE	Langenwang Pilot	Austria	Langenwang	Werner Pink
HYSTORE	Stockholm Pilot	Sweden	Stockholm	Qian Wang
HYSTORE	Monserat Pilot	Spain	Barcelona	Josep Altayo
HYSTORE	Dublin Pilot	Dublin	Ireland	Eleni Mangina



GETTING IN TOUCH WITH THE EU

In person

All over the European Union there are hundreds of Europe Direct information centres. You can find the address of the centre nearest you at: https://europa.eu/european-union/contact_en

On the phone or by email

Europe Direct is a service that answers your questions about the European Union. You can contact this service:

- by freephone: 00 800 6 7 8 9 10 11 (certain operators may charge for these calls),
- at the following standard number: +32 22999696, or
- by email via: https://europa.eu/european-union/contact_en

FINDING INFORMATION ABOUT THE EU

Online

Information about the European Union in all the official languages of the EU is available on the Europa website at: https://europa.eu/european-union/index_en

EU publications

You can download or order free and priced EU publications from: <https://op.europa.eu/en/publications>. Multiple copies of free publications may be obtained by contacting Europe Direct or your local information centre (see https://europa.eu/european-union/contact_en).

EU law and related documents

For access to legal information from the EU, including all EU law since 1952 in all the official language versions, go to EUR-Lex at: <http://eur-lex.europa.eu>

Open data from the EU

The EU Open Data Portal (<http://data.europa.eu/euodp/en>) provides access to datasets from the EU. Data can be downloaded and reused for free, for both commercial and non-commercial purposes.



Publications Office
of the European Union

ISBN 978-92-68-05726-1

bridge